

MESA/BOOGIE

**RECTIFIER™ STEREO
2:ONE HUNDRED**

Owner's Manual

Hello from the Tone Farm...

YOU, the smart player and all around intuitive human, have put your trust in us to be your amplifier company. This is something we do not take lightly. Our reward is that we've made a classic amplifier and by choosing this amplifier, you have become part of the MESA family...Welcome! Our goal is to never let you down. Your reward is that you are now the owner of our most popular selling power amp, the 2:100. Bred of fine all tube amp heritage...benefiting from the many patented pioneering MESA/Boogie circuits that led to the refinement of your new instrument. Feel confident, as we do, this product will inspire many hours of musical satisfaction and lasting enjoyment. It was built with you in mind, by players who know the value of a fine musical instrument and the commitment it takes to make great music. The same commitment to quality, value and support we make to you...our new friend.

RECTIFIER™ STEREO 2:ONE HUNDRED

TABLE OF CONTENTS

Precautions

OVERVIEW _____ 1/2

FRONT PANEL CONTROLS & SWITCHES

LEVEL CONTROLS _____ 2

PRESENCE _____ 2

POWER ON _____ 3

STANDBY _____ 3

MODERN _____ 3

REAR PANEL - SWITCHES & JACKS

INPUTS A / B _____ 4

BIAS SWITCH _____ 4

GROUND LIFT _____ 5

SPEAKER JACKS _____ 5

TUBE BAY _____ 6

DRIVER TUBES 12AX7A _____ 6/7

AC RECEPTACLE _____ 7

LINE FUSE _____ 7

TUBE MAINTENANCE

DIAGNOSING POWER TUBE FAILURE _____ 8

DIAGNOSING PRE-AMP TUBE FAILURES & PROBLEMS _____ 9

Feature Article by Randall Smith On Bias Adjustment _____ 10/12

SPEAKER HOOK-UP GUIDE & IMPEDANCE MATCHING _____ 13/14

POSSIBLE HOOK-UP SCHEMES - Amplifier to Speaker Cabinets _____ 15/18

WIRING EXAMPLES USING THE SIMUL-CLASS 2:100 _____ 19/20

Feature Article By Randall Smith On How Tubes Work _____ 21/23

PRECAUTIONS & WARNINGS

Your MESA/Boogie Amplifier is a professional instrument. Please treat it with respect and operate it properly.

USE COMMON SENSE AND ALWAYS OBSERVE THESE PRECAUTIONS:

WARNING: EU: permission from the Supply Authority is needed before connection.

WARNING: Vacuum tube amplifiers generate heat. To insure proper ventilation always make certain there is at least four inches (100mm) of space behind the rear of the amplifier cabinet. Keep away from curtains or any flammable objects.

WARNING: Do not block any ventilation openings on the rear or top of the amplifier. Do not impede ventilation by placing objects on top of the amplifier which extend past the rear edge of its cabinet.

WARNING: Do not expose the amplifier to rain, moisture, dripping or splashing water. Do not place objects filled with liquids on or nearby the amplifier.

WARNING: Always make certain proper load is connected before operating the amplifier. Failure to do so could pose a shock hazard and may result in damage to the amplifier.

Do not expose amplifier to direct sunlight or extremely high temperatures.

Always insure that amplifier is properly grounded. Always unplug AC power cord before changing fuse or any tubes. When replacing fuse, use only same type and rating.

Avoid direct contact with heated tubes. Keep amplifier away from children.

Be sure to connect to an AC power supply that meets the power supply specifications listed on the rear of the unit. Remove the power plug from the AC mains socket if the unit is to be stored for an extended period of time. If there is any danger of lightning occurring nearby, remove the power plug from the wall socket in advance.

To avoid damaging your speakers and other playback equipment, turn off the power of all related equipment before making the connections.

Do not use excessive force in handling control buttons, switches and controls. Do not use solvents such as benzene or paint thinner to clean the unit. Wipe off the exterior with soft cloth.

Be sure to have the warranty card filled out by the store at which it was purchased and return to *Mesa/Boogie*.

YOUR AMPLIFIER IS LOUD! EXPOSURE TO HIGH SOUND VOLUMES MAY CAUSE PERMANENT HEARING DAMAGE !

No user serviceable parts inside. Refer service to qualified personnel. Always unplug AC power before removing chassis.

EXPORT MODELS: Always insure that unit is wired for proper voltage. Make certain grounding conforms with local standards.

READ AND FOLLOW INSTRUCTIONS OF PROPER USAGE.

RECTIFIER™ STEREO 2:ONE HUNDRED

Operating Instructions

Overview:

Congratulations on your choice of the **RECTIFIER STEREO 2:100** as your power amplifier and welcome to the **MESA/Boogie** Family. This 2 rack space unit is born of legendary stock and traces its lineage to the mighty **Dual Rectifier Solo Head**. Here the stunning performance of the **Dual** is faithfully recreated in a stereo format that duplicates the power section exactly when the **Dual** is set to its Silicon Diode rectifier setting. Rectifier tubes were not included in this package, as their size did not permit inclusion along with an overall consensus among players asked, that those needing 200 watts of this type of aggressive power would require the tighter, faster response of the silicon diodes. The eight 6L6 power tubes (4 per side) are fan cooled and kick out 100 watts of all-tube power per channel. Three 12AX7s' make up the driver section and these are housed inside the unit. Preamp tubes used in this manner rarely wear out as there is little or no exposure to excessive vibration and they are operating under minimal gain requirements .

The **RECTIFIER STEREO 2:100** is a "smart" power amplifier as it contains the MODERN Switchable Voicing feature. It responds to a trigger pulse sent by either of its companions, the **Rectifier Recording Preamp** or the **TriAxis Programmable Preamp**. When a cable is connected to the MODERN trigger port and this feature is switched via any tip-to-ground type logic, the negative feedback in the power section of the **2:100** is reduced, unleashing a sound of true ferocity. This is a trademark sound in the **Dual** and **Triple Rectifier Solo Heads** and has become the most recorded sound in heavy modern rock.

FRONT VIEW 2:100

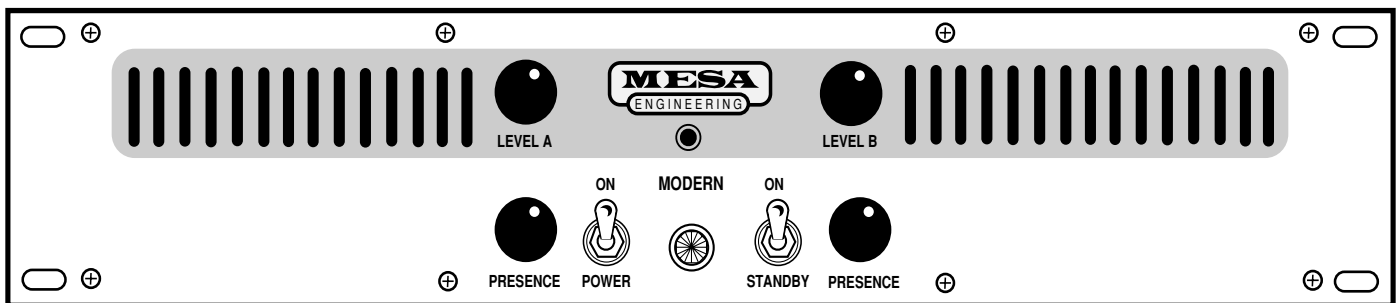

REAR VIEW: 2:100

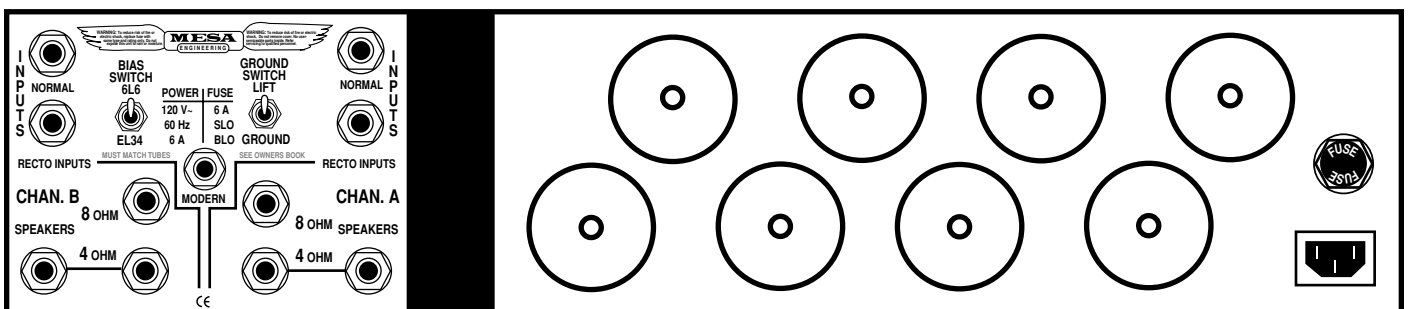

Overview: (Continued)

Without further delay, connect up your favorite preamp and get ready to experience one of the most commanding sounds in rack-mount history as *Recto* power goes stereo for the first time in this amazing package.

NOTE: BEFORE YOU MOUNT THE 2:100 IN YOUR RACK! This is an extremely aggressive and powerful amplifier intended for use with one of the above mentioned *MESA* preamplifiers in large venues. If after trying it you feel you may have chosen more amp than you need, you may find one of the more forgiving *MESA* stereo power amplifiers such as the *Stereo 2:50* or the *Stereo Simul-Class 2:90* more suited to your style or application. Save the packing material and keep the amplifier in perfect condition and you should be able to return it to the place of purchase for full credit toward one of the less aggressive models that might perhaps better suit your needs. If this stunning, aggressive power well suits your playing style and needs, congratulations and by all means rock on.

And now on to the controls and features of your new *2:100*. Please take some time along the way and read this operating manual, it will prove to be quite worth while in the end and will help you to enjoy your new amplifier to its full extent.

FRONT PANEL CONTROLS

LEVEL CONTROLS: Each channel of the *2:100* has its own **LEVEL** Control. If the amplifier is being fed by signals from a typical pre-amp, try a setting of 2 as a starting point. If the amp is being fed by lower-level signals such as those from (minus) -20db type effects units, etc..., you may need to raise the Levels as high as 2:00 or 3:00.

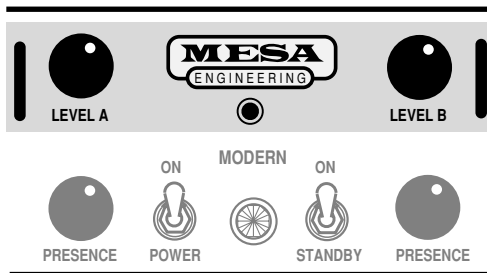

NOTE: Remember to turn the **LEVEL** Control to zero on any channel not connected to a speaker or load resistor! **A Load must be present at all times when either channels' LEVEL Control is dialed to anything other than zero.** Failure to comply to this procedure can cause serious damage to your *2:100's* power section.

PRESENCE CONTROLS: Each channel on the *2:100* has its own "active" **PRESENCE** Control. These controls provide a boost in the upper mid-range/lower Treble zone, which are the frequencies that tend to get obscured in the energy of live performance; use them when you need to cut through a "loud mix."

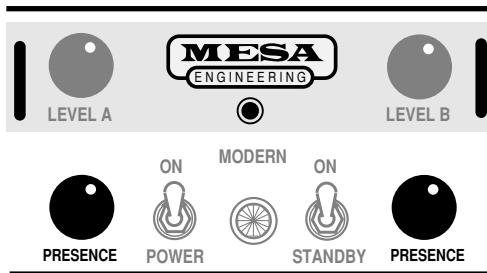

Use these **PRESENCE** Controls with discretion as they can make for some ear damaging, almost harsh sounds if set too high - especially if the **TREBLE** Control on your pre-amp is dialed up extremely high.

FRONT PANEL CONTROLS: (Continued)

POWER SWITCH & POWER UP: First remove the protective covers from the tubes (plastic webbing) before connecting the A.C. cord to a power receptacle.

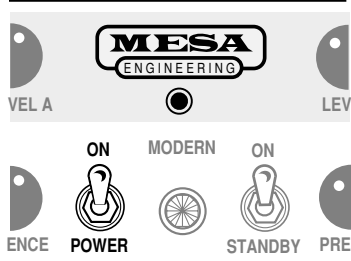

Make all necessary connections including pre-amp, effects, speakers and instrument before you flip the STANDBY switch to its ON position. AC power is turned on via the **POWER** switch and indicated by the pilot lamp. Before switching on the power, place the STANDBY switch into its Standby position and allow at least 30 seconds of warm-up time before switching the STANDBY switch to the ON position.

This start up procedure helps extend tube life by preventing a high voltage turn-on surge. (However, all of our amplifiers are tested to withstand this extra stress, just in case this procedure is neglected by the user.) But ignoring this procedure everytime the amplifier is used will shorten the tubes toneful life.

Never remove any of the power cords terminals. All three terminals of the A.C. power cord must be connected and always check that the power receptacle has the proper voltage present. Also, make sure that the power cord is inserted all the way in when connecting to a power receptacle.

STANDBY SWITCH: Perfect for set breaks...this toggle switch also serves an even more important purpose. In the standby position the tubes are at idle so that during power up they may have a chance to warm up before being put to use.

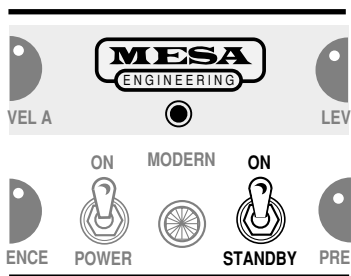

Before the power is switched on, make sure the **STANDBY** switch is in the standby position. And as mention above, wait at least 30 seconds before changing to the **ON** position.

MODERN: This jack is the trigger port for the auto-tracking **MODERN** feature. This jack can receive a trigger pulse from the corresponding jack on the *MESA Rectifier Recording Preamp* or *Triaxis Programmable Preamp*. This smart power amp auto-modifies the amount of negative feedback in the power section when the **MODERN** mode in Channel 2 of the *Recto Preamp* is selected or switched to via the Footswitch. The Front Panel LED indicates when the feature is active and negative feedback has been reduced.



If used with the *Triaxis* - use one of the 4 programmable switch jacks and store under a user preset. This reshaping is crucial to the sound of the **MODERN** mode and using this feature duplicates the circuit and the performance of this punishing mode in the *Dual & Triple Rectifier Solo Heads*.

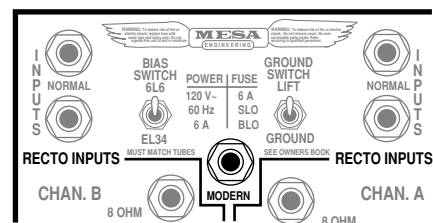

NOTE: Use unshielded cable of good quality when connecting the **MODERN** trigger port to your preamp or master switching unit. Shielded cable will also work ,but is unnecessary.

REAR PANEL FEATURES:

REAR VIEW: 2:100

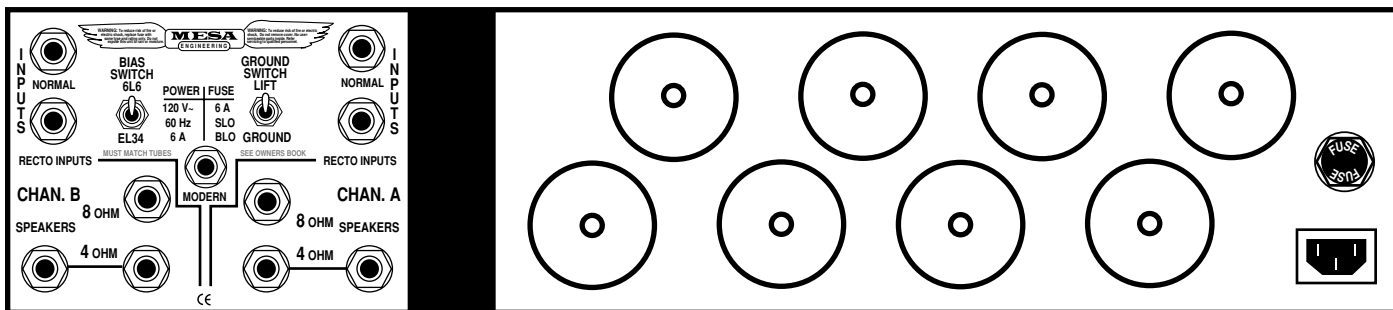

INPUTS: Located on the Rear Panel, these two 1/4" jacks are the Channel A and Channel B inputs for the **2:100**. These are the inputs for pre-amps and/or effects, depending on how you have your system wired. You may drive the **2:100** with your pre-amp directly or choose to come from the last effect in a chain and drive the power amp this way. Either way is fine and up to your preference. The amplifier is stereo, offering two separate channels of amplification. If you wish to use only one of its channels, it is necessary to: **1) Make sure a speaker (or load resistor) remains connected to a speaker jack on both channels, including the unused one; or 2) Turn the LEVEL Control of the unused channel to zero.** (This is necessary because an amplifier channel receiving any amount of signal at its input will require a "load" at its output - or damage will most likely result.)

The **RECTO INPUTS** are wired such that when the companion **Rectifier Recording Preamp** is used, the circuit remains exactly true to the signal path between preamp and power section as it occurs in the **Dual** and **Triple Rectifier Heads**. To achieve this duplication, a driver tube responsible for the effects return stage and all related circuitry in the **2:100** must be removed and this includes the LEVEL Controls as they are part of this circuitry. As a result, when using the **RECTO INPUTS**, you will use the Recto Pre LIVE OUTPUT Control as your overall final master level control.

TUBE BIAS: Your **2:100** was designed with versatility in mind. The **BIAS SWITCH** allows you to adapt the power output section of the **2:100** in order to use the other classic pentode power tubes, the British style **EL 34**. These tubes are largely responsible for the signature sound of many immediately identifiable and wonderful sounding amps created in Great Britain and used on some of the best recordings to date. The nature of their sound is usually brighter in the extremely high frequencies...some players find this almost thin at first. However, aficionados of the **EL34** sound know that nothing has the lushness of harmonics or spread like a power amp using **EL34's**. In truth **EL34's** do focus in on a region of upper harmonics that **6L6's** reproduce, but not really enhance, in the same way the **EL34's** do.

This characteristic is sometimes preferred for sounds that range from a soft clip that would be used for chording or soloing, to an all out high gain crunch or lead sound. Players that use mostly these types of sounds may prefer the **EL34** clip to the **6L6's** that come standard in the **2:100**. If you need a variety of sounds and rely on a clean chording sound much of the time, you will likely prefer the stock compliment of **6L6's** that the **2:100** comes fitted with. We feel the **6L6** is a more balanced sounding tube that produces plenty of harmonic lushness, while at the same time delivering the rich lows that are crucial to both a warm clean sound and huge, tight high gain crunch sound.

REAR PANEL (Continued)

TUBE BIAS: (Continued) **We recommend the 6L6 for reliability:** In our many tests and continued use of the currently available EL34 type power tubes on the market today, we regret to say that they do not appear to be as rugged in construction as the available 6L6. This is another reason why your *2:100* was shipped with 6L6 power tubes. If you plan to use the EL34's we suggest that you keep a full set of tubes and extra fuses with you during all performances in the event of a tube failure occurring when using the currently available EL34's.

GROUND LIFT: This mini-toggle switch is extremely useful in reducing the hum and buzz caused by ground loops which occur in rack installations. Ground loops occur when there is more than one path for grounds between electronic units. There are three main type of ground loops; each one contributes its own trademark component of buzz or hum. The three types of ground loops are:

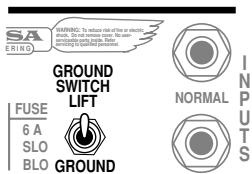

1) Grounds being connected via the ground lugs of the power cords on the units. The rule-of-thumb here is that one and only one unit in a rack should have a connection to the AC power ground; all the other units in the rack should have their grounds lifted by using 3 to 2 adaptors on their AC plugs. We suggest grounding the Power amp (no adaptor).

2) Ground loops occurring because of two or more audio cables connecting two components. The most common solution is to disconnect the shield from the sleeve connection at one end of some of the inter-connecting cables, so that only one cable between each device has an intact ground shield. Some experimentation is required to find which cable is best for conducting the ground, and which cables are best suited to have the special "clipped ground." We recommend trying the intact-ground cables for the signal path which flows, say, from an Effects Send jack to an effects unit; and trying the clipped-ground method on the cable which connects the effects output back into an Effect Return.

3) Ground loops created by the physical contact between the metal chassis of the components and the steel rack rails. It is for this third type of ground loop that the **GROUND ISOLATION** Switch was provided. This switch effectively lifts the electronic circuit ground from the metal chassis ground (which otherwise must be done manually by disconnecting a wire inside of the amp.) Here again, the rule is that one device in your system - and usually only one - needs its circuit ground connected to its metal chassis ground; all others should be lifted (in other words, disconnected) for quietest operation. (Some effects units provide similar switches; some are constructed such that the input ground and the output ground are permanently separated; in other cases, the method used to isolate the grounds is unclear.) Again, some experimentation is vital to discovering which combination of "lifted" and "grounded" works best in your rack...and our **GROUND ISOLATION** Switch makes this process much easier.

NOTE: If the *2:100* is operated outside of a rack installation, the switch should generally be set to the Normal position, or squealing, buzzing and oscillation may occur. Always check this switch before thinking that something has gone wrong with your amp!

SPEAKER OUTPUTS: The *2:100* provides one 8 Ohm and two 4 Ohm speaker outputs for each channel. When using a single 8 Ohm speaker or 8 Ohm cabinet on a channel, connect the speaker or cabinet to the 8 Ohm jack. If using two 8 Ohm speakers (assuming they are wired in parallel) or cabinets on a channel, plug them both into the 4 Ohm jacks. (The logic here is that two 8 Ohm loads connected in parallel add up to a 4 Ohm total load.) Mismatching of speaker impedance will not cause damage or severe loss of power. (Extreme mis-matches will decrease tube life, however.) *MESA/Boogie* 4x12 and 4x10 cabinets come standard wired to 8 Ohms and are wired in series-parallel.

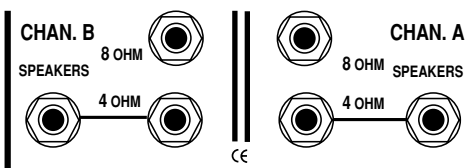

Some Non-*MESA* 4x12 cabinets are wired 16 Ohms using four 16 Ohm speakers. By wiring all four speakers in parallel, you can reduce the cabinet to an impedance load of 4 Ohms (assuming the speakers are 16 Ohms each.) Further back in this manual we have included a number of possible wiring schemes - amps to cabinets, that may be of some use to you when considering how to configure your rig.

REAR PANEL (Continued)

SPEAKER OUTPUTS: (Continued) **NOTE:** If you opt to use only one channel of the 2:100 with speakers connected to that channel's output only, you must turn the unused channel's level control to zero! Otherwise the channel will be operating without a load, and damage to the tubes and/or the transformer will result.

TUBE BAY: The power tubes used in the 2:100 are *MESA/Boogie* STR-430 type 6L6 GC's. These tubes have been tested in the amplifier during several "burn-in" periods before leaving the factory. You can expect 6 months to 2 years (or more) of outstanding performance from your *MESA/Boogie* power tubes, depending on use. Tube wear is gradual and usually goes unnoticed until new replacements are installed. Worn power tubes tend to sound flat with reduced punch, clarity and high end. Occasional loss of power or sporadic blowing of fuses is nearly always caused by troublesome power tubes.

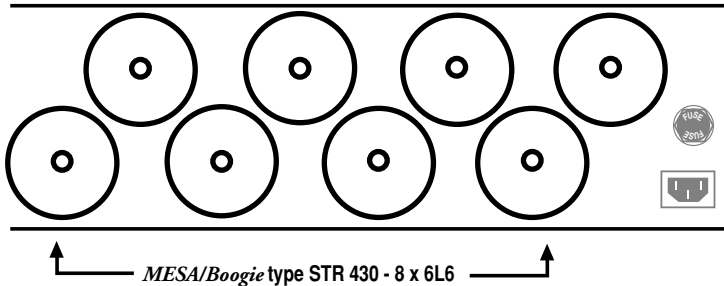

Often, you can spot the tube at fault and replace it alone, at considerable savings over replacing all the output tubes. A tube that arcs or "flashes over" inside should be replaced immediately. (In an emergency, you can just remove the bad tube and go on with the show...running on 3 cylinders.) Sometimes a tube will "short out" intermittently, turning red-hot all over the large metal plate inside. But usually

a momentary switching off of the STANDBY or POWER Switch will enable the tube to straighten out its electron flow and return to proper operation. Should this happen repeatedly, careful observation will usually reveal which tube is shorting, even though one or two others may also turn red-hot after a few moments.

By viewing the tubes, try to verify which one is reddest or turns red first - that is the bad one and the others are most likely unharmed. Internal circuitry is built to withstand tube failure as much as possible; even if damage were to occur, it would be minor and easily repairable.

When replacing tubes, please use only the *MESA/Boogie* types specified. Using other tube brands and/or types will invalidate your amplifier's warranty! To remove tubes, you must first push back the spring retainers clamped against the tube base. When re-installing power tubes, check that the spring clamps are making good contact with the tube base; bend them in toward the center before plugging in the tube, if necessary. Avoid excessive wiggling of the tubes when removing or installing them, as it can break off the small plastic key which insures correct orientation of the tube in the socket. Make sure you check out the sections on Power Tube and Pre-Amp Tube maintenance located further back in this manual. Some helpful tips on prolonging the life of your amplifiers' tubes makes these maintenance sections worthwhile reading.

DRIVER TUBES: 3 x 12AX7A The three small tubes are type 12AX7A, also known as 7025 or ECC83. These tubes are very long lasting and trouble free in the 2:100; should they ever need replacement due to a specific malfunction, genuine *MESA* replacements are recommended for best performance.



NOTE: You must remove the top cover of the chassis in order to gain access to the driver tubes. These tubes can become quite warm. Allow them to cool down before changing and it's always a good idea to power down the unit when changing any of the tubes.

Also, be aware that some of the circuitry components (namely the large round capacitors running parallel to the three driver tubes) will store a substantial amount of electrical charge even after the amplifier is powered down. For safety reasons be sure

REAR PANEL (Continued)

DRIVER TUBES: 3 x 12AX7A to grab hold of the particular pre-amp tube when replacement is required. Do not allow your fingers, hands or rings/jewelry to come into contact with any other part (s) of the amplifier's internal circuitry.

No other user serviceable parts exist in side. Refer service to qualified personnel. Always unplug AC power before removing the top cover of the amplifier.

AC RECEPTACLE: The total power consumption for the *2:100* is 6Amps @ 120 Volts. Thus, a 15 Amp circuit (which is what most house circuitry is wired with) is adequate. Make sure the Euro style A.C. power cord is firmly seated in the power receptacle before powering up the unit. Always connect the A.C. cord to a 3 terminal grounded socket. If none are available, connect the A.C. power cord to a ground lift adaptor and then connect to a 2 terminal outlet. This may also be necessary from time to time for noise problems.

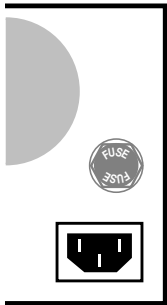

This style of power cord will make tear-downs and cable routing a lot easier and save you time as well. If you should ever need a replacement, just call and we'll be happy to send you another one for a nominal charge or visit your nearest *MESA/Boogie* Pro Center.

LINE FUSE: This is the *2:100's* A.C.'s (Alternating Current) main fuse and provides protection from outside A.C. fluctuations, as well as power tube failure damage. Should the **FUSE** blow, replace it with the same rating in a slo-blo type package. The domestic **U.S. version requires a 6 Amp SLO-BLO FUSE**. A power tube short or failure is often the cause of a blown fuse...**Follow the cold start procedure mentioned earlier in the ON / STANDBY switch section** and watch the power tubes as you flip the STANDBY to the ON position. If a power tube is going bad or is arcing you will see it!

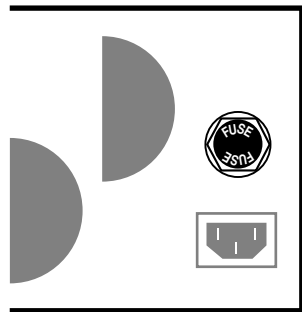

Flip the STANDBY switch to STANDBY immediately and replace the faulty power tube and the **FUSE** if necessary. If you see nothing abnormal as you lift the STANDBY switch, it is possible that a power tube shorted temporarily and blew the **FUSE**. If this is the case it may work again normally.

To be extra safe you may want to replace all power tubes in the troubleshooting tradition and save the replaced set as spares. Carry along a few extra fuses for they too could be worth their weight in gold someday.

TUBE NOISE & MICROPHONICS

You may occasionally experience some form of tube noise or microphonics. Certainly no cause for alarm, this quirky behavior comes with the territory and the Tone. Much like changing a light bulb, you don't need a technician to cure these types of minor user serviceable annoyances and in fact, you'll be amazed at how easy it is to cure tube problems...by simply swapping out a pre-amp or power tube!

First may we suggest that you set the amplifier up on something so that you can get to the tubes comfortably without having to bend down. It also helps to have adequate lighting as you will need to see the tube sockets clearly to swap tubes. Use caution and common sense when touching the tubes after the amplifier has been on as they may be extremely hot! If they are hot and you don't want to wait for them to cool off, try grasping them with a rag and also note that the glass down around the bulbous silvery tip is considerably less hot which makes it easier to handle. Gently rock the tube back and forth as you pull it away from its socket.

DIAGNOSING POWER TUBE FAILURES:

There are two main types of tube faults: shorts and noise. Both large and small tubes may fall prey to either of these problems but diagnosis and remedy is usually simple.

If a fuse blows, the problem is most likely a shorted power tube and shorts can either be mild or severe. In a mildly shorted tube the electron flow has overcome the control grid and excess current flows to the plate. You will usually hear the amp become distorted and begin to hum slightly. If this occurs, quickly look at the power tubes as you switch the amp to STANDBY and try to identify one as glowing red hot. It is likely that two of a pair will be glowing since the "shorted" tube will pull down the bias for its adjacent mates, but one tube may be glowing hotter — and that one is the culprit. The other two are often fine — unless they've been glowing bright red for several minutes.

Because there is no physical short inside the tube (just electrons rioting out of control) merely switching to STANDBY for a few moments then back to ON will usually cure the problem...at least temporarily. Watch the tubes carefully now. Should the problem recur, the intermittent tube will visibly start to over heat before the others and thus it can be identified. It should be replaced with one from the same color batch, shown on its label. Call us and we will send one out to you.

The severe short is not nearly so benign. In the worst cases, a major arcing short occurs between the plate and the cathode with visible lightning inside the glass and a major noise through the speaker. If this is seen to happen, IMMEDIATELY turn the amp to STANDBY. By this time the fuse probably will have blown. Such a short is usually caused by a physical breakdown inside the tube including contaminate coming loose or physical contact (or near contact) between the elements. Replace it and the fuse with the proper slo-blo type and power up the amp using the power up procedure as we described earlier in this manual.

TUBE NOISE:

Often caused by contamination within in a tube, the culprit can usually be identified, and by lightly tapping on the glass, you will probably hear the noise change. Hearing some noise through the speakers while tapping on the 12AX7's is normal however. And the one nearer the INPUT will always sound louder because its output is being further amplified by the second 12AX7.

The power tubes should be all but quiet when they are tapped. If crackling or hissing changes with the tapping, you have probably **TUBE NOISE CONTINUED:** found the problem. To confirm a noisy power tube, merely put the **2:100** on Standby, remove it from its socket and turn it back on. It will cause no damage to run the **2:100** briefly with one power tube missing. You may notice a slight background hum, however, as the push-pull becomes unbalanced. Whenever you are trying to diagnose a suspect tube, keep your other hand on the POWER and STANDBY switches ready to shut them off instantly in the unlikely case you provoke a major short.

If you think you've located a problem tube but aren't sure, we recommend substituting the suspect with a new one just to be sure of your diagnoses. You will be doing yourself and us a big favor by just following the simple guidelines previously mentioned regarding tube replacement. You'll probably be successful with much less effort than is required to disconnect everything and haul the unit to a technician who will basically perform the same simple tests. If the tubes are still within their six-month warranty period, we will happily send you a replacement. Just note the color designation on the tube label so that we can send you the appropriate match.

DIAGNOSING PRE-AMP TUBE PROBLEMS: Because your amplifier is an all tube design, it is quite possible that you will at some point experience minor pre-amp tube noise. Rest assured - this is no cause for alarm and you can take care of the problem yourself in a matter of minutes by simply swapping tubes.

Let us begin by saying; It is a "very good" idea to keep at least a couple of spare pre-amp tubes on hand at all times to insure uninterrupted performance. These minor pre-amp tube problems can take many forms but can generally be described in two categories: Noise and Microphonics. Noise can be in the form of crackling, sputtering, white noise/hiss and/or hum. Microphonic problems usually appear in the form of a ringing or high pitched squealing that gets worse as the gain or volume is increased thus are more noticeable in the higher gain "HI" modes. Microphonic problems are easily identified because the problem is still present even with the instruments' volume off or unplugged altogether - unlike pick-up feedback which ceases as the instrument is turned down. Microphonic noise is caused by mechanical vibration and shock: think of banging a microphone around and you'll understand where the word came from.

The best way to approach a pre-amp tube problem is to see if it occurs only in one specific mode or channel. This should lead you to the tube needing replacement. Then all that remains is to swap the suspect tube for a known good performer.

If you cannot narrow down the trouble to a specific mode or channel, the problem may be the small tube that drives the power tubes which is operational in all modes and channels. Though rare, a problem with the driver tube would show up in all aspects of performance - so if you can't narrow the problem down to being mode or channel specific, you may want to try replacing the driver tube. Driver problems generally show themselves in the form of crackling or hum in all modes of performance and/or weak overall output from the amplifier. Occasionally an anemic driver tube will cause the amplifier to sound flat and lifeless, but this is somewhat uncommon, as worn power tubes are a more likely suspect for this type of problem.

Sometimes making the diagnosis is more trouble than it's worth and it's faster and easier to merely replace the small pre-amp tubes ONE AT A TIME with a replacement known to be good. But MAKE SURE you keep returning the tubes to their original socket until you hit the one that cures the problem. You'll notice that tubes located nearer to the INPUT jack always sound noisier...but this is because they are at the start of the chain and their noise gets amplified over and over by the tubes that follow. The tube that goes into this "input socket" (usually labeled V1) needs to be the least noisy of the bunch. The tube that goes at the end of the preamp chain - just ahead of the power tubes - can be quite noisy without causing any problem at all. The tubes in your amp have already been located in the most appropriate sockets and this is why you should NEVER pull them all out at once and ALWAYS swap them one at a time. ALWAYS return a perfectly good tube to its original socket. Also it's a good idea to put the amp on STANDBY when swapping tubes to reduce the heat build up in the tubes themselves and to prevent explosive noises (which can still occur even if you are pulling the tubes away from their sockets gently) from coming through the speaker.

Remember, take your time, be patient and chances are real good that you can fix your amp yourself by finding and replacing the bad tube. It kills us to see someone who has shipped their amp back to us...and all it needed was a simple tube replacement! If you must send back your amp, unplug the power cord, speaker and reverb cables then remove the chassis from the cabinet by unscrewing the four mounting bolts on top. The chassis then slides back like a drawer and comes out. Remove the big power tubes and mark them according to their location from left to right 1, 2 etc. They need to be wrapped separately with plenty of wadded up newspaper around them and put in a smaller box within the larger carton.

To wrap the chassis, use plenty of tightly wadded up newspaper so there is at least six inches of "crush space" between the chassis and the cardboard box. Bubble wrap also works well, but please DON'T use styrene peanuts - they will shift during transit and get lodged inside your electronics as well as allowing your amp to end up at the bottom of the box unprotected and possibly damaged. Pre-amp tubes don't normally wear out as a rule.

Therefore, it is not a good idea to change them just for the sake of changing them. If there isn't a problem - don't fix it. If there is no result from your substitutions, it may be possible that you have more than one problematic tube. Though rare, this does happen and though it makes the troubleshooting process a little more intimidating, it is still possible to cure the problem yourself.

NOTE: *It is normal to hear a slight metallic ringing sound when tapping on the preamp tubes. As long as the tube does not break into oscillation or start crackling or any other form of bizarre noise, it is considered normal and functional.*

BIAS ADJUSTMENT: part of a continuing series

An Article written by Randall Smith

Here's a question we often hear:

"Why doesn't *MESA* put bias adjustments in their amplifiers?"

Well, there's a short answer and a long answer to this question.

The short answer is that during my 12 years of repairing Fenders, one of the most frequent problems I saw was bias controls that were either set wrong or that had wandered out of adjustment due to vibration. As any honest tech will tell you, there's lot's of easy money to be made by sprinkling "holy water" on amplifiers ... uh, what I meant to say is "Your amp needed biasing." See what I mean? What customer is going to argue with that?

It only takes a moment and a volt meter: The Fender diagram shows how: "Adjust this trim pot for - 52 volts." That's it. Nothing more.

Now don't be fooled into thinking that tubes "draw" more or less bias, they don't. The way a bias supply is connected to a tube is akin to a dead end road, it just trails off to nowhere without really completing a circuit. It's a static voltage and regardless of what tube is in the socket — or even if the tubes aren't plugged in at all, it doesn't change the bias voltage a bit.

So the end of the short answer is this: Since a bias supply needs to put out the right voltage and never vary, I wanted to build amplifiers that were individually hard wired to the correct values and NEVER needed adjustment. And for 25 years, that's how *MESABoogies* have been built.

Time to change tubes? Just plug our tubes into any one of our amps and you're DONE. No tech needed. NO bills and no BS about biasing. And most important: The bias is RIGHT because it can't change!

Now, you want the long answer? Here's more information on how our hard-wired bias avoids trouble. Please read on.

But first, let's make an important distinction. Our business is designing and building high performance amplifiers. And for this we need tubes whose variance is within a narrow range. Our warehouse is full of rejects ...oh, they work — they just don't perform within our tolerance range. We have a very sophisticated computer - based tube testing system (nicknamed "Robotube") that matches and measures tubes over seven important parameters. It can even predict which tubes are likely to have a shortened lifetime — even though they work perfectly during the test.

Because our business is building quality amps, we can afford to reject a lot of wayward tubes. The guys you hear complaining because *Boogies* don't have bias adjusters are primarily in the business of selling tubes - not amps. They don't want to throw away 30 percent of their inventory, so they promote the idea that tubes outside our parameters can be used to "customize" amplifiers and they criticize us because our amps can't be adjusted to accommodate their out-of-*MESA* tolerance tubes.

Now you might be thinking, "But I thought you just said that tubes don't "draw" bias, therefore they don't effect the bias supply and thus it doesn't need to be adjustable."

When you set the bias (whether it's by selecting the right resistors, as we do, or adjusting a trimmer — which is quicker) what you are doing is establishing the correct amount of idle CURRENT that flows through the power tubes. But you can't adjust the current directly, you can only change it by adjusting the amount of bias VOLTAGE that goes onto the tubes' control grids.

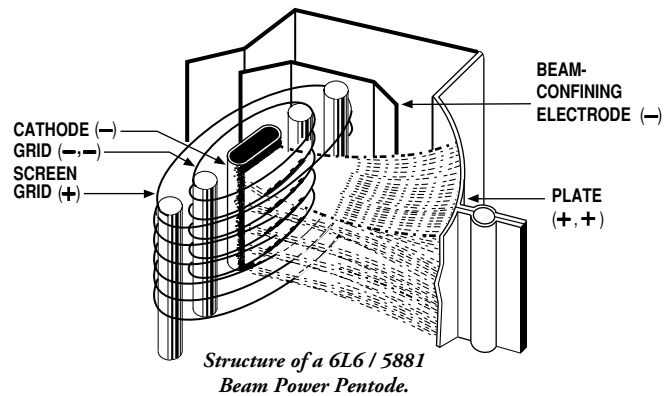

BIAS ADJUSTMENT: (Continued) Voltage and current are NOT the same. Current is the AMOUNT of electricity, the “quantity” — and is measured in amperes. Voltage is the degree of electric charge — like the “pressure” to use the old water analogy. Let me illustrate how different voltage and current are:

When you scrape your feet across a carpeted floor in dry, wintery conditions, your body can become charged with 50,000 to 100,000 volts of static electricity. And when you reach for the door knob, a spark jumps and you feel it! The voltage is super high but the current (measured in micro-amps) is tiny - otherwise you would die from electrocution.

Contrast this with your car battery, which puts out a mere 12 volts. You can lay your hands right across the terminals and not feel a thing. Yet the amount of current available can run to several hundred amperes .. enough to turn over a cold engine and get it started.

So current and voltage are two totally separate electrical parameters — though when you multiply them together, you get POWER, which is measured in watts.

When you set the bias of an amplifier, you are adjusting the static VOLTAGE at the control grid of the tube in order to produce a desired amount of idle CURRENT flowing to the tube's plate. A small change in grid voltage, produces a large change in the amount of current flowing — and that's basically how a tube works. Say that again because it's super important: A small change in voltage at the grid causes a large change in current flowing to the plate. See, that's the essence of amplification: A small change causing a large change. And here it's a small voltage change causing a large current change.

The bias conditions are what determines how much current flows through the big power tubes when you're not playing. And what drives your speakers is fluctuations in that current flow when ARE playing. If the amount of current increases and decreases 440 times per second, then you'll hear an A note. If the fluctuations in current flow are large and still at 440 per second, you'll hear an A that is LOUD!

But for purposes of biasing, it's the amount of “plate current” flowing with no signal applied that's important. Unfortunately current is hard to measure because the circuit must be interrupted — as in “cut the wire” — and the meter spliced “in series” with the broken circuit. But measuring VOLTAGE is easy. It is not necessary to interrupt the circuit because a voltage reading can be taken in PARALLEL with the circuit intact.

Thus, as a matter of convenience, most bias settings are given in volts at the grid ... even though current through the plate is the important factor. In fact plate current is so inconvenient (and dangerous) to measure that Fender doesn't even state what the correct value should be. They only give the grid voltage that will produce that current. (That's the minus 52.) But that only happens if the tubes being used are “in spec.”

As long as the tubes ARE “in spec”, the right bias voltage will always give the correct plate “CURRENT” — but then there's no need for the bias voltage to be adjustable!

If the tubes are NOT in spec, then the only proper way to re-set the bias is to cut the circuit and measure the current while adjusting the bias ... but no manufacturer I know even STATES the desired current value! Be that as it may, when the original bias voltage is altered far enough, it will compensate for the tube's abnormal performance and the correct amount of idle current flow may then be restored. Clearly this is something most repair techs should not attempt.

Some newer amps have LED indicators connected to the circuit which will turn on when the right threshold of current flow has been reached. This is an improvement, and almost worthy if you're willing to except resistors and lights added into your amplifier's audio path — which we aren't.

The other “advantage” of this system is that it allows some amp manufacturers to avoid matching their power tubes. The thinking is that adjusting the bias to each tube separately eradicates the inherent differences between the tubes by insuring that the same current flows through each one.

BIAS ADJUSTMENT: (Continued) Again, this has some merit .. but it's still not as good as using tubes that are matched in the first place because compensating for the mis-match causes the push-pull circuit itself to become unbalanced. Two wrongs don't really make a right.

Some of the other recommended biasing, "methods" — such as -".. tubes running red hot, increase the bias .. sounds harsh and runs too cool, turn it down ..." are guesswork at best. Luckily, one of the great things about tube amps is that they can usually stand some abuse without causing any real harm ... at least not immediately.

But don't these alterations imply that you are second-guessing the amp designer and that there's a better set of operating conditions that the designer missed but the tube sellers have discovered?

Now some players may like the sound of their amp altered by tubes with extreme characteristics and with the bias set to help compensate. But often it is the mere novelty of change that they're really responding to and when the amp goes back to the proper original way, we've seen them be far happier still!

Because every part in every one of our designs has been meticulously evaluated, compared and stressed over — no matter how seemingly insignificant it might be. And with every design we look for a "sweet spot" where all the parameters — including the bias — come together to give the best sonic performance, consistently and reliably. Every part and voltage is important — yet no one complains that these other parameters aren't available for tinkering.

Consider our patented *Simul-Class* circuitry where there are two different bias voltages used for separate pairs of power tubes ... and changing one voltage also changes the other. Great care goes into getting this just right and we think we'd be asking for trouble to have it adjustable for the world to play with ... unless you like paying to have your amp messed up. Sorry, I meant to say, "Uh, ... your amp needed biasing."

If that doesn't appeal to you, then merely plug a matched set of *MESA* tubes into one of our amps and you're ready for tone. Guaranteed. You'd be amazed at the number of service calls we field every day that lead to a diagnosis of out-of-tolerance, non-spec tube problems. To think these would be prevented by including a bias adjustment is something of an insult to you and us. If you put the wrong size tires on your car, do you think changing the pressure will make them right?

Please, don't think this is a blanket indictment of the other guys selling tubes — it isn't. And their tubes aren't all bad either. It just doesn't make sense to pay more of your hard earned cash for tubes that were probably made in the same Russian or Chinese factory and which have the possibility of being outside the performance window we select for your amp. And it pains us to hear the hype and mystique built up around biasing when twenty-five years of evidence affirms our decision to make bias circuits that "never need adjustment". How much money and trouble that has saved *MESA/Boogie* players you couldn't estimate.

Our rigorously tested and hand selected tubes are available at your nearest *MESA/Boogie* Pro Center or from us directly. Nobody offers better price, quality or warranty than we do ... so why swerve?

Next time we'll talk about our part in developing the great Sylvania STR 415 type 6L6 and how we're on the verge of seeing something fairly close reappear on the market. Remember, we still have some of these super rugged mondo-bottles available for older amps — *Boogies* only please! Until then, Relax, Breathe and Nourish your soul!

Cheers!

MESA/Boogie Ltd.

Randall Smith
Designer & President

SPEAKER IMPEDANCE MATCHING & HOOK-UP GUIDE:

IMPEDANCE: Wiring up speakers to provide the most effective load and making sure that all of them are in phase will help in creating the best sound possible. This is not too difficult, as long as you understand a few things about loading and how to connect your speakers to provide an optimal resistive load.

MESA/Boogie amplifiers can handle 4 and 8 ohms effectively. Never run below 4 Ohms in a tube amplifier unless you are absolutely certain that the system can handle it properly; this can cause damage to the Output transformer. A few amplifiers can handle 2 Ohms effectively without damaging them (for example the *MESA'S Bass 400+*). You can always have a higher resistance (16 Ohms, for example) without damaging results, but too low of a resistance will likely cause problems.

MIS-MATCHING: When running a higher resistance (for example: 8 Ohm output into 16 Ohm cabinet), a slightly different feel and response will be eminent. A slight mismatch can provide a darker smoother tone with a little less output and attack. This response is a result of the amplifier running a bit cooler. Sometimes when using more than one cabinet a mismatch will be the only option.

WHAT IS MY CABINETS IMPEDANCE: If you have only a single speaker, you just match that single speakers impedance to the amplifier, and you are done. In many cases, you will have a number of speakers, and then you must calculate the "load" that the amplifier will need to support. There are generally three ways to wire multiple speakers together. They are as follows:

SERIES: When you wire (hook-up) speakers in Series, the speakers resistance (as measured in ohms) is additive - i.e. putting two 8 Ohm speakers in Series results in a 16 Ohm load.

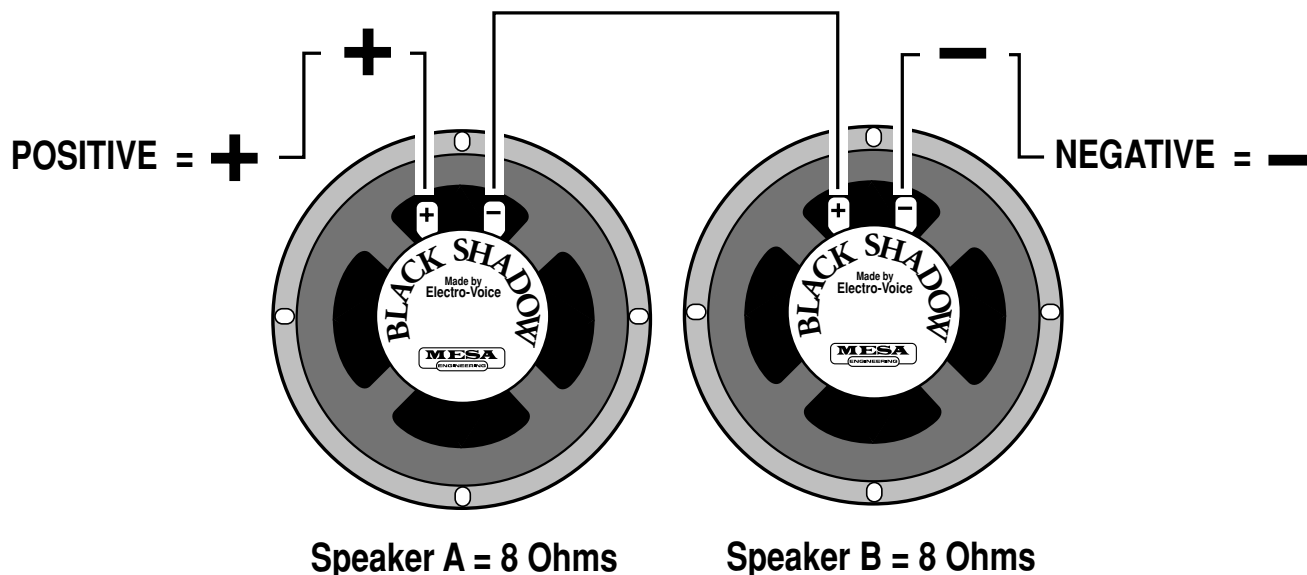

SERIES: Connect the Negative side of Speaker A to the Positive side of Speaker B

SPEAKER IMPEDANCE MATCHING & HOOK-UP GUIDE: *(Continued)*

PARALLEL: When wiring in parallel, the resistance of the speakers decreases. Two 8 Ohm speakers wired in (hooked-up) Parallel results in a 4 Ohm load. It's easy to calculate the effect of a resistive load when all the speakers are all the same resistance. It is really not suggested to wire different resistive load values in Parallel (8 and 4, 16 and 8 etc.) The formula for figuring the total impedance in Parallel is the multiplication of the two loads divided by the sum of the two loads - i.e. putting two 8 Ohm speakers in Parallel results in a 4 Ohm load. Connect the Positive side of Speaker A to the Positive side of Speaker B - Connect the Negative side of Speaker A to the Negative side of Speaker B.

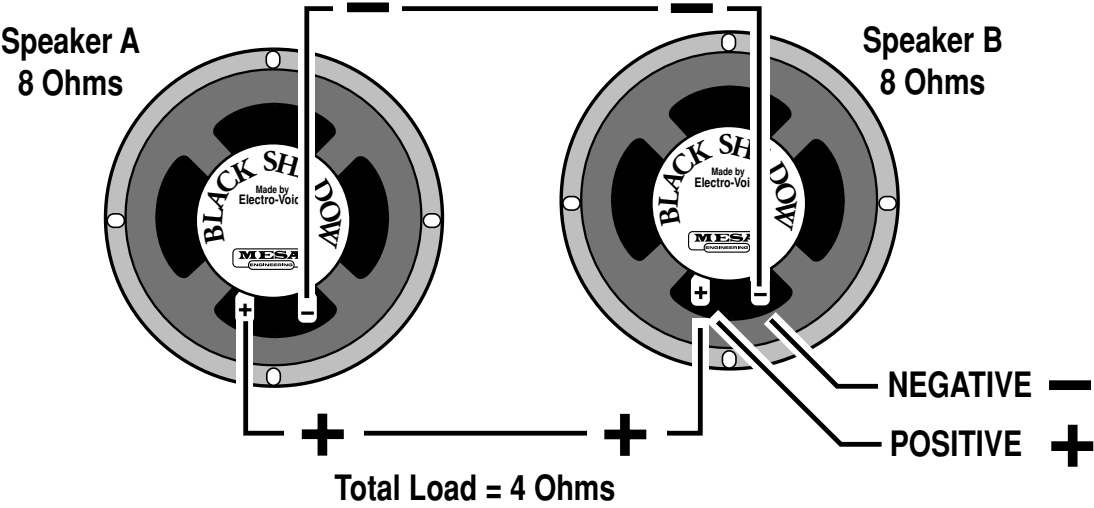

COMBINATION OF SERIES & PARALLEL: This is really just two sets of Parallel wired speakers connected in series. This is how you maintain a consistent load with multiple speakers.

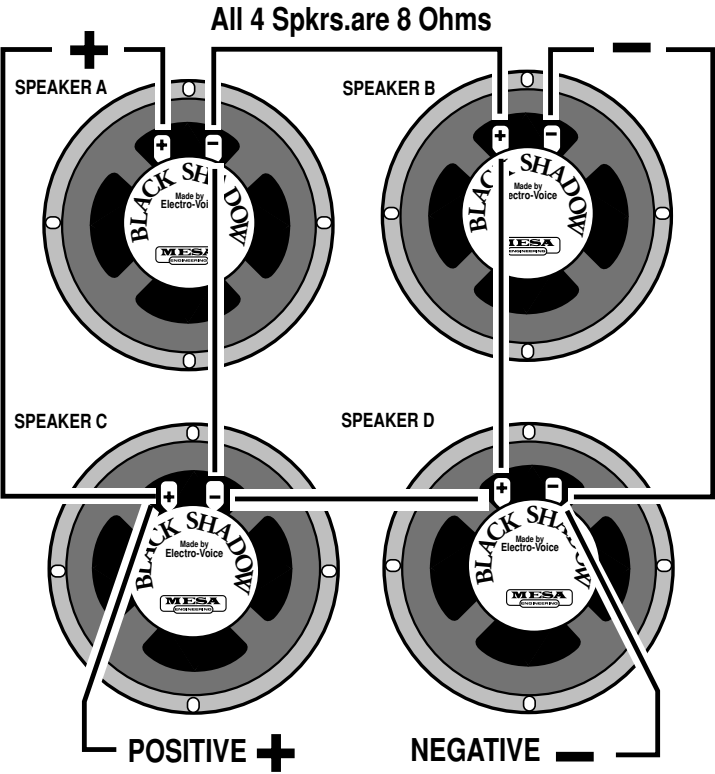

The importance of this is more evident when you have more than one cabinet to connect to your amplifier. This is when you need to figure out the loads and how to wire them up without applying too low of a resistance on the amplifier.

Simply connect the Positive side of Speaker A to the Positive side of Speaker C.

Connect the Negative side of Speaker A to the Positive side of Speaker B, then on to the Positive side of Speaker D and finally on to the Negative side of Speaker C.

And lastly, connect the Negative side of Speaker B to the Negative side of Speaker D.

4 Eight (8) Ohm speakers wired in Series Parallel + a Total Load of 8 Ohms.

WIRING SCHEMES...Amplifier to Speaker Cabinets

1

2

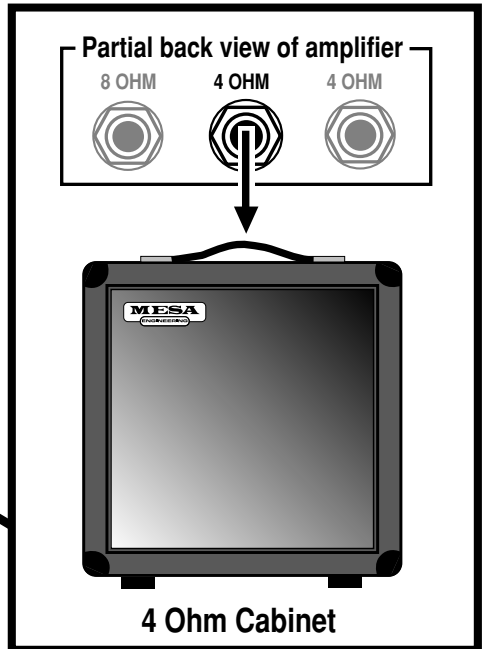
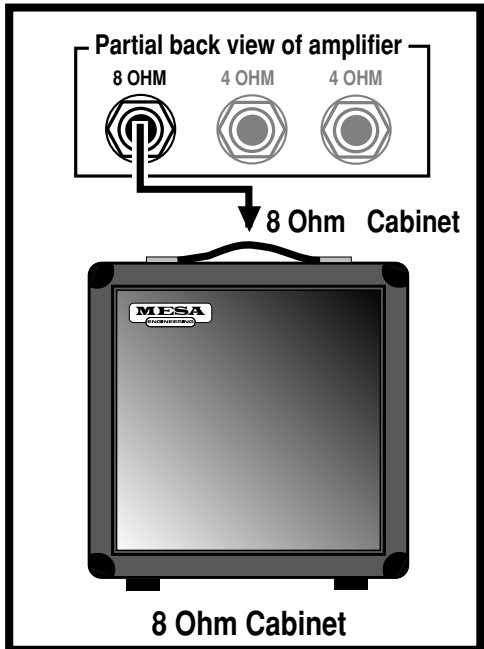

3

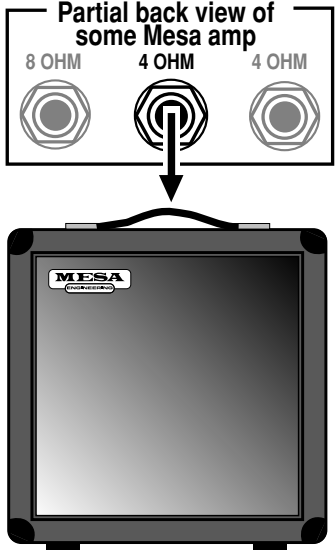

4

5

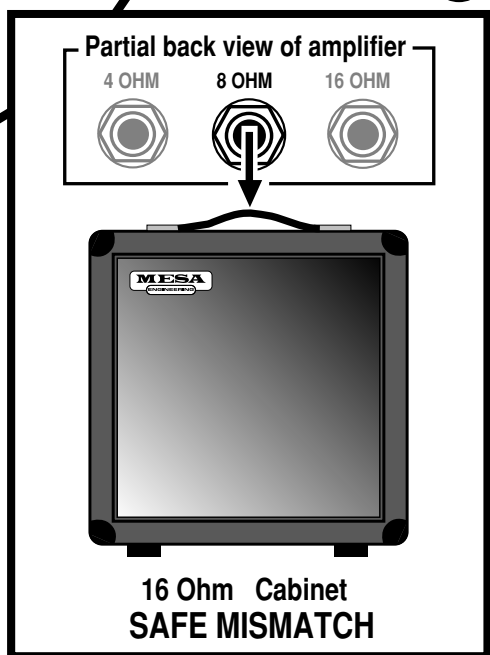
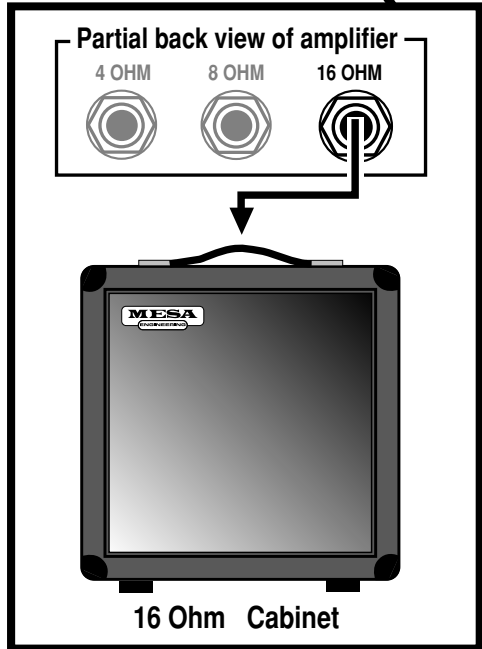

WIRING SCHEMES...Amplifier to Speaker Cabinets

6

7

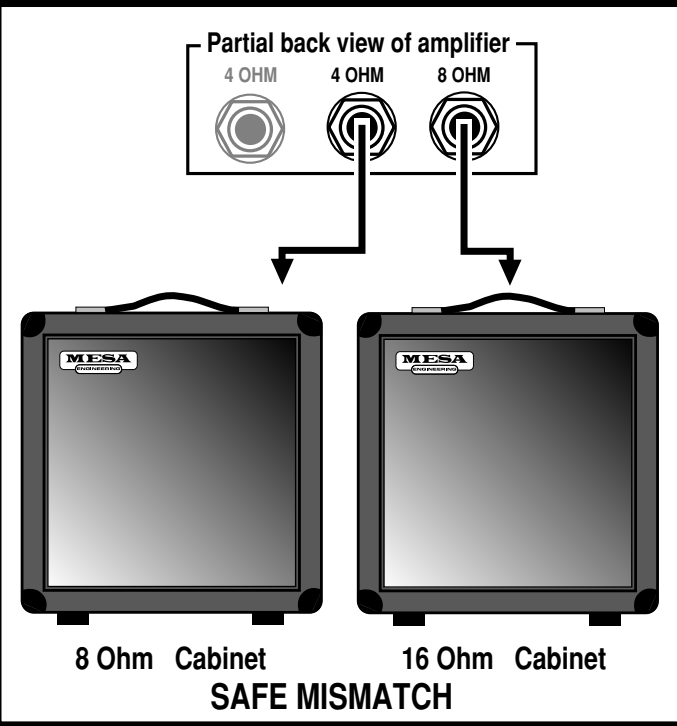
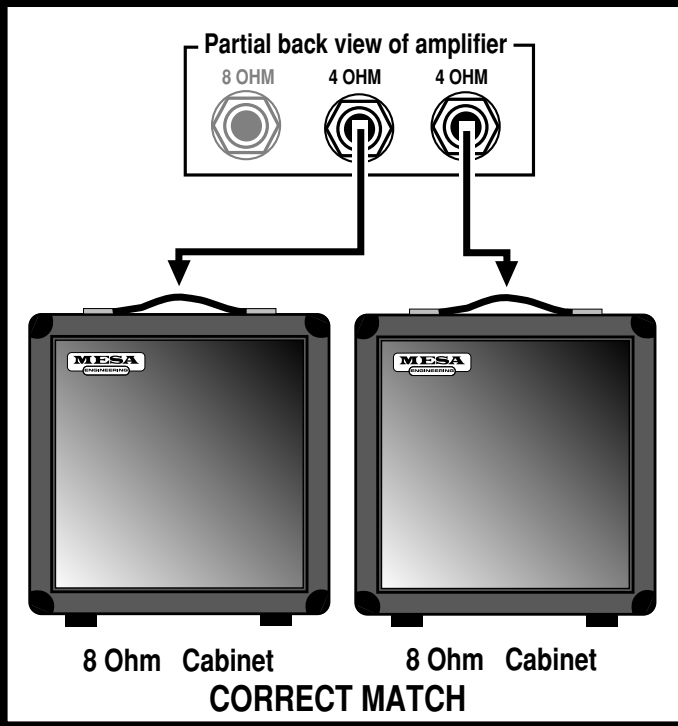

8

9

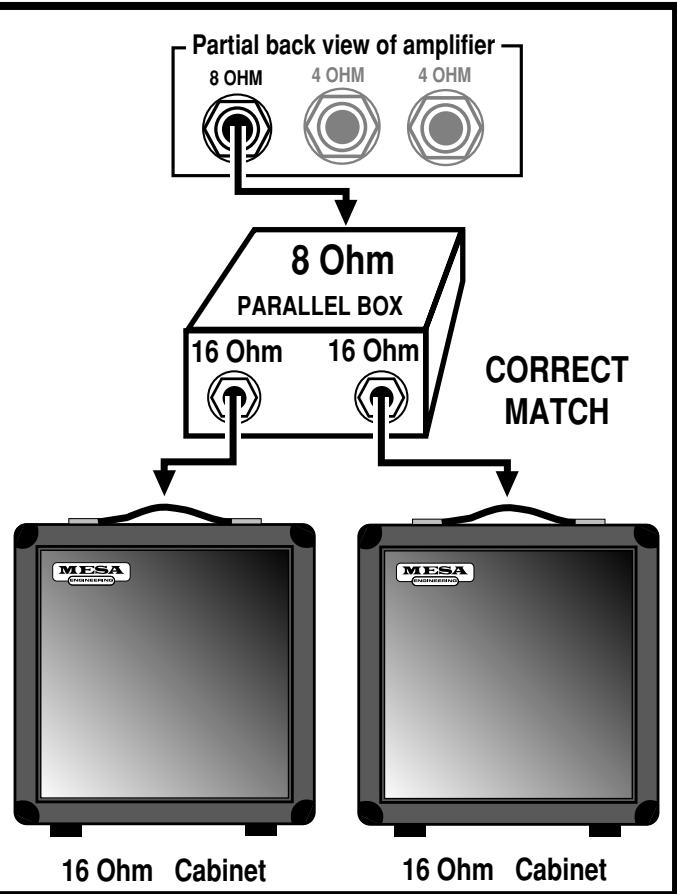
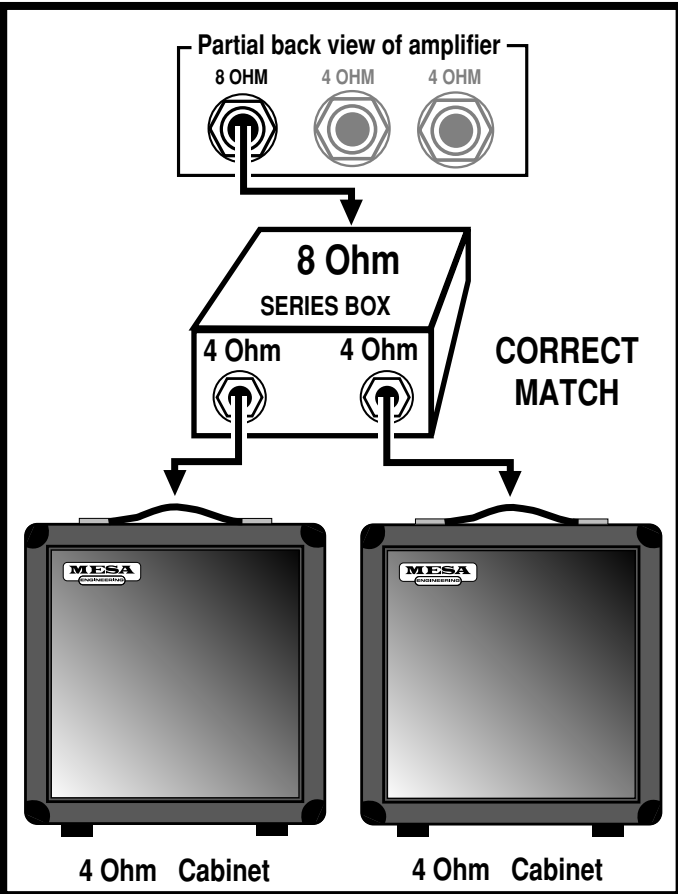

WIRING SCHEMES...Amplifier to Speaker Cabinets

10

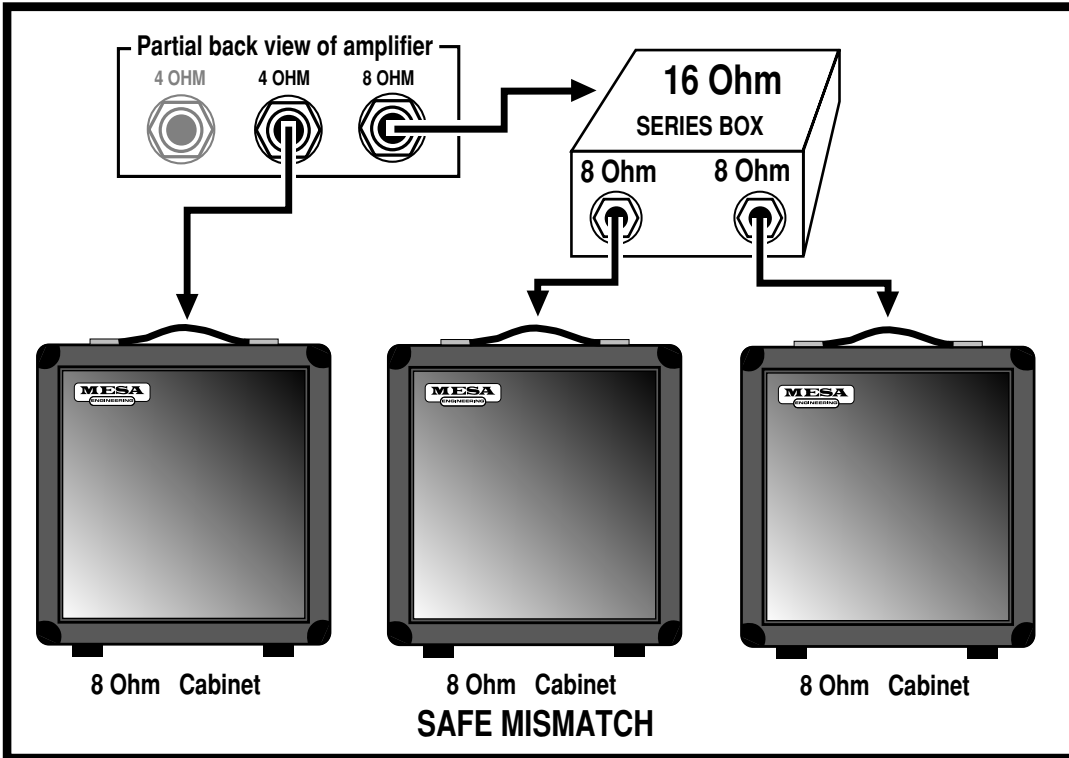

11

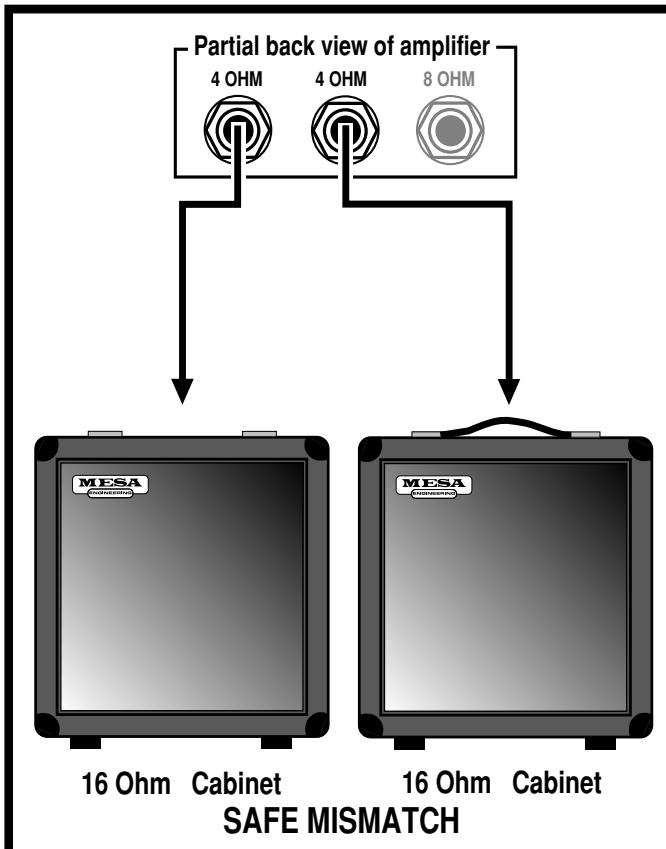

12

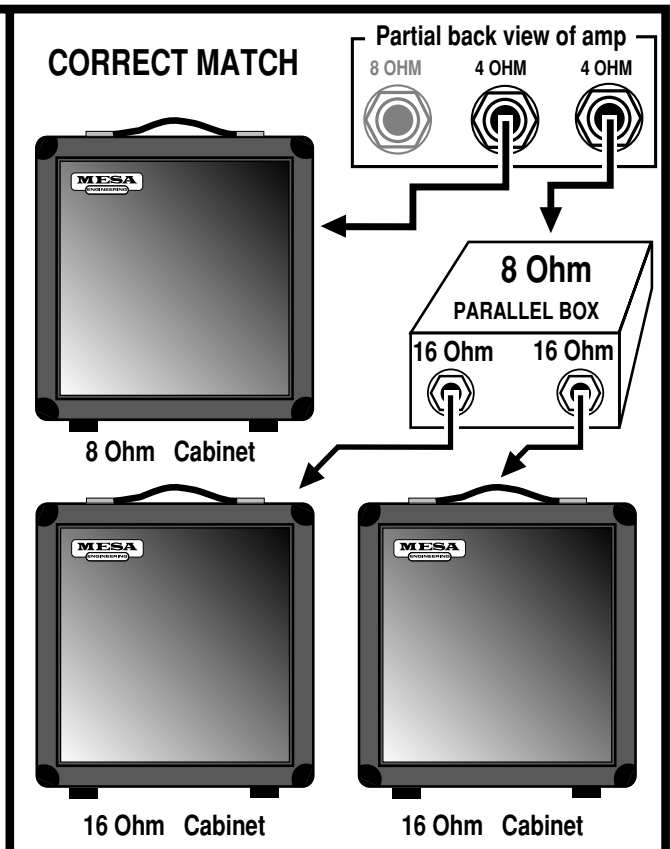

WIRING SCHEMES...Amplifier to Speaker Cabinets

13

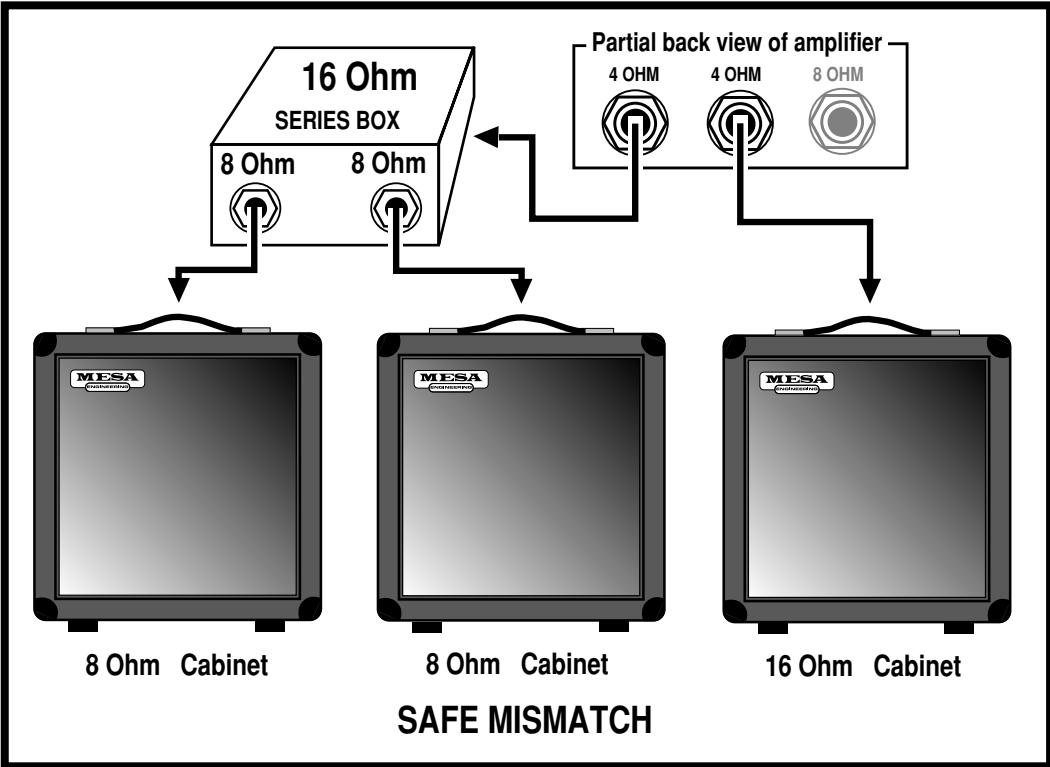

14

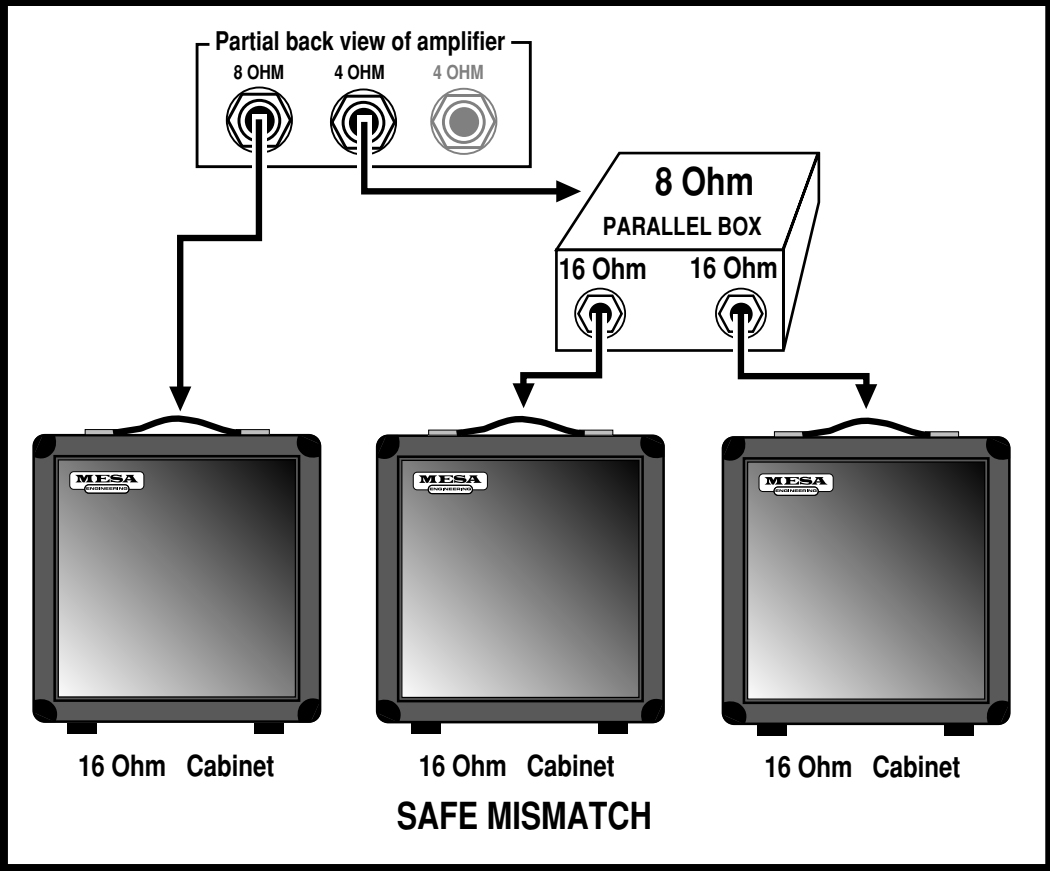

WIRING EXAMPLE #1

Mesa/Boogie all tube Formula Pre-Amplifier

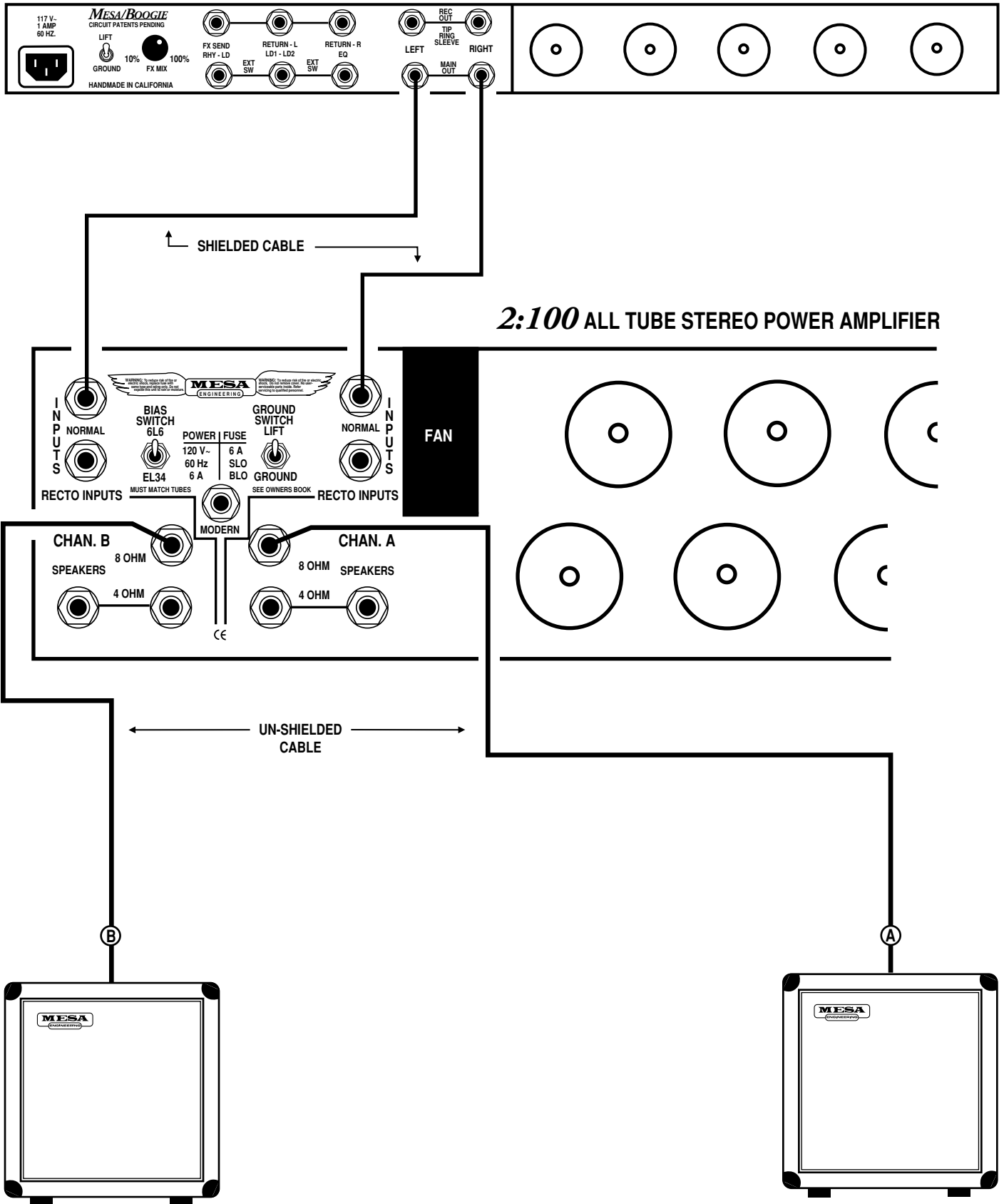

SUGGESTED WIRING #2

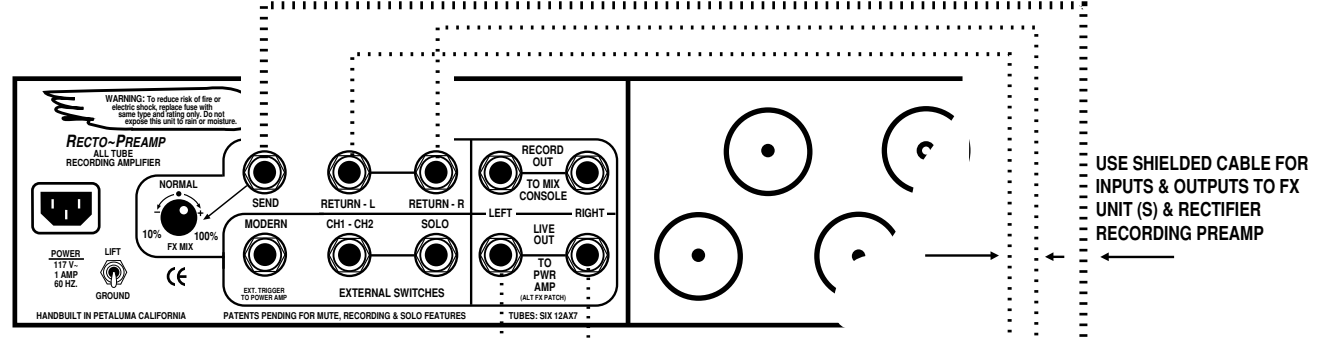
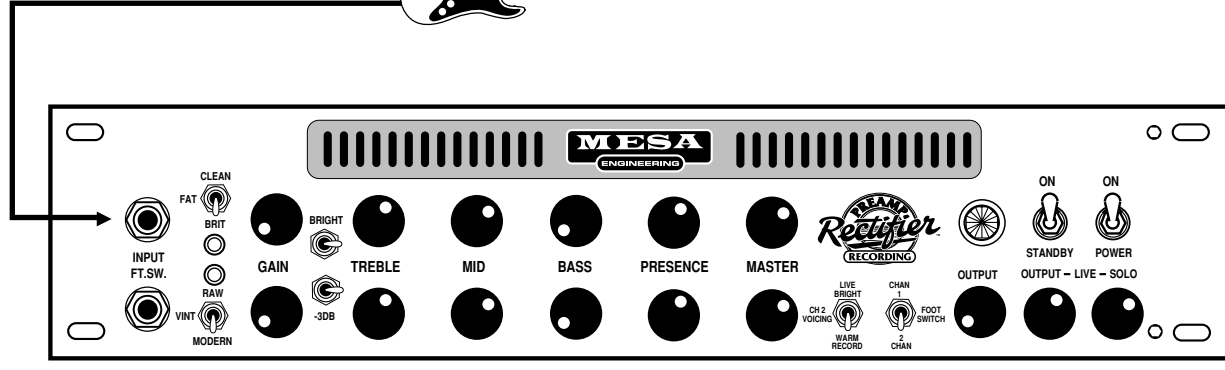

USE SHIELDED CABLE FOR INPUTS & OUTPUTS TO FX UNIT (S) & RECTIFIER RECORDING PREAMP

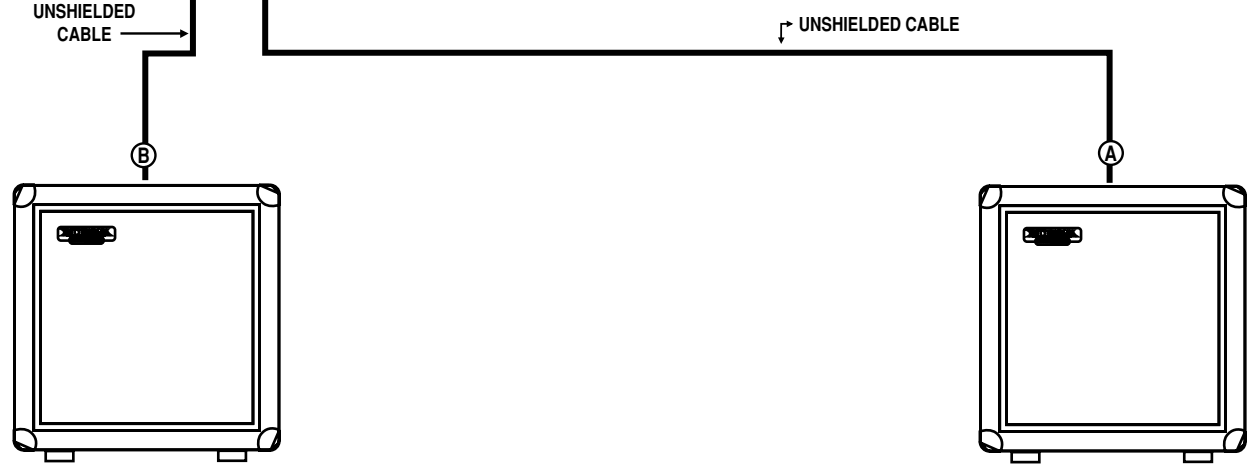
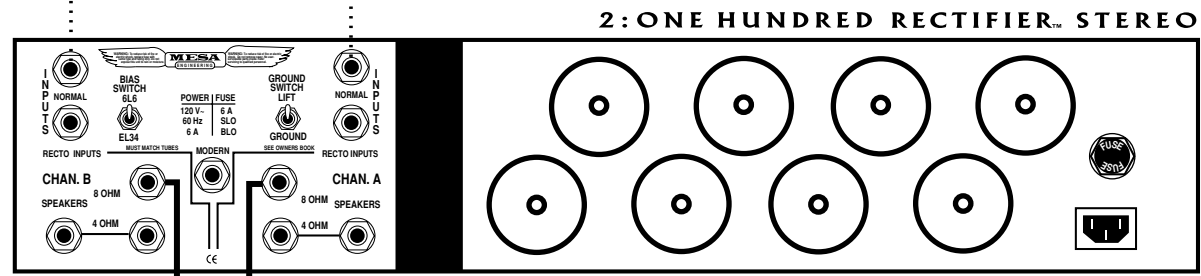
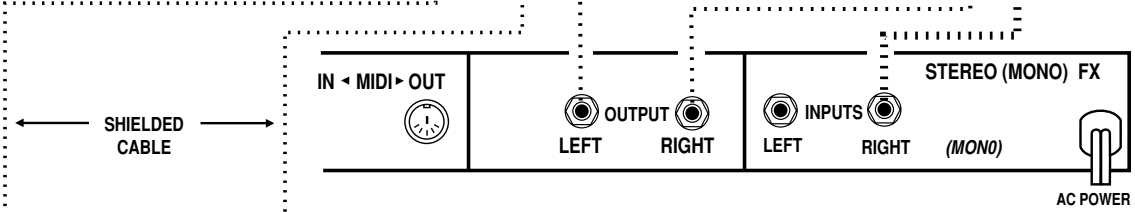

With apologies to Friends and Relatives from the Emerald Isle - who will make their appearance soon enough - the humor which follows is dedicated to the memories of Spec McAuliff and Fae (Rafael) McNally, two of the True Greats.

As their numerical references suggest, the terms Diode, Triode and Pentode indicate the number of elements within the vacuum tube i.e. two, three or five. All tubes also require a filament or heater which is not included in the count. Its purpose is to excite electrons from the cathode coating by raising the temperature such that they are able to boil out of the electron-rich coating material and form a cloud of free electrons in the vacuum space surrounding the cathode.

Although the term filament and heater are often used interchangeably, there are specific differences: A filament is a directly heated cathode where cathode coating is applied directly to the heating element. Examples are 5U4 twin diode rectifier and 300B triode amplifier tubes. A heater, on the other hand, is a heating element which is separate from the cathode and is usually inserted within the tubular cathode sleeve. Examples are 12AX7 twin triode amplifier and 6V6 or EL84 beam power pentode tubes. In all cases this fundamental aspect of each tube's construction is clearly visible, especially when the heating element is glowing red hot.

The cathode, then, would be considered the first numbered element because it is the source of the electrons. The word itself is from the Greek literally meaning completely down, which implies a sense of central origin - like the center of the earth where Tone begins. It might be said that an ecstatic audiophile experiences a positive catharsis, his soul being purified when his system transports him to Audio Nirvana. The only trouble with taking this positive imagery too far is that the cathode is, unfortunately, negative... at least electrically speaking. However this is easily remembered since virtually all musicians and audiophiles have also experienced the more common negative catharsis when they emerge from the emotional rebirth kicking and screaming in rage and frustration.

Once heated, the intrinsically negative electrons are energetic little fellows of almost no mass. Thus they may be accelerated almost instantaneously and will travel through a vacuum a nearly the speed of light. Being of like, negative charge, they tend to repel one another and thus within the electron cloud surrounding the cathode, there is much jostling and elbowing as each one tries to maintain his distance from all the others... unless there is a strong and universal attraction from an outside influence.

Visualize, if you will, a group of sub-atomic Irishmen milling about and in a repellent, negative state of mind. All are scowling and none wants to have anything to do with the other. Now introduce a strong attraction say, a public bar, and you can easily picture an orderly, if rapid movement of the lot in a single direction. This is what happens when a positively charged element called the anode or plate is introduced into the vacuum.

The plate is the large metal element most prominently visible through the glass of an electron tube. It is the outermost element of a tube's structure and it surrounds all the others. The cathode is at the center radiating electrons outwards. As higher and higher positive voltage is applied to the plate, the attraction for the electrons surrounding the cathode is increased and with nothing standing in the way, full uninhibited flow to the plate occurs... sort of like removing the doors and offering free drinks to the crowd of surly Irishmen milling around outside. As electrons flow to the plate, the space charge will continually be replenished by further 'boiling' of the hot, electron-rich cathode as you can easily imagine other Irishmen impatiently taking up the places of those who've gone inside - until the entire village is deserted.

Now, where do they come from and how do they emerge? Well, a grand and elegant lady once showed me how to revive flat champagne: She dropped a raisin into the glass. There was a dramatic and immediate increase in effervescence with the introduction of a cathoding surface. Thousands of tiny bubbles suddenly appeared - and continued to flow from the raisin. Of course the bubbles were made up of gas dissolved in the beverage, but the analogy makes it easy to visualize the loosely bound electrons dissolved in the rich cathode coating as they effervesce from its heated surface.

But back to the electron flow. If the electrons are strongly attracted to a positively charged plate, then it follows that they are strongly repelled by a negatively charged plate and they are. Thus, if an alternating current - such as comes from a transformer - is applied to the plate, electrons will flow only during the times when the plate is positively charged. During periods of negative plate charge, electron flow is stopped and the space charge of electrons remains compressed in the area around the cathode.

ON TRIODES, PENTODES & IRISHMEN: (Continued)

Thus a diode tube - one with a cathode and an anode - is mostly used to rectify alternating current into direct current by passing it without a cathode and an anode - is mostly used to rectify alternating current into direct current by passing it without restriction, but in one direction only. This also explains why closing time is strictly enforced at Irish pubs: During normal operation, the traffic flow is similarly unimpeded and uni-directional toward the bar and this process rectifies the work-day negativity. It goes without saying that no one leaves as long as the atmosphere around the bar remains positively charged.

TRIODES: This section is a continuing technical treatise on the workings of Irish Pubs but to make it easier for the layman to understand, it is explained in terms of vacuum tube technology. Enter the original bar - free beer and no doors. Well, it turns out that some control over the flow can be a necessary and useful advantage. This led to the invention of those swinging louvered saloon doors which are open at the top and bottom. They are patterned after the control grid of the vacuum tube, which is a loosely wound coil of thin wire located between the cathode and the plate.

In a Triode the plate is always positively charged with high voltage D.C. and even though the grid is blocking the path, those negative electrons can still FEEL the strong attraction - just as the Irishmen can see in through the louvers of the bar doors. They know what pleasures lie beyond, but to get there requires overcoming the negative influences controlling the access. This negative influence is typically called a Bias. In electronic terms that means the grid is supplied with a voltage which is slightly MORE NEGATIVE than the already negative electrons. The more negative the Bias, the more it tends to neutralize the attraction of the plate and repel the electrons back toward the cathode.

The Irish can be similarly charged with Bias, but unless you are Irish yourself, this type of Biasing may be more difficult to understand. The effect is similar though: The more negative the Bias, the more it impedes forward progress. Generally speaking though, the electronic Bias of the grid is easier to overcome, and for two main reasons: First, the Bias is set - like the bar doors - to allow some passage. Second, the grid is mostly NOT THERE, like the louvered doors which are mostly open spaces. Unlike the plate which is solid, the grid is like a coiled bed spring. It can create a repelling field but mostly it's empty space in between widely separated windings of wire. It's very easy to control the electrons as they pass through the grid's force field: Changing the grid voltage only slightly will have an enormous effect on how much current flows through... and that's what AMPLIFICATION is: a small change in voltage at the grid causing a large change in current flowing to the plate.

The purpose of the louvered bar doors is similar to that of the grid, namely, to give momentary pause while still revealing the promise within. Hesitation mostly gives way to temptation, but there are those few stalwart Irishmen who think twice and decide to come back later. Most just pause slightly then go on through. That is the purpose of the bar doors: to prevent everyone from crowding in all at once - and as the door is made less of a barrier, wider spaces between the louvers, more of the bar's attractive influence is felt outside thus amplifying the customer flow and increasing the crowd at the bar.

PENTODES: Occasionally though, bar doors - even the louvered type - were found to be too effective, and too many customers turned away. Something further was needed to increase the attraction of the bar and overcome the resistance created by the door. Thus the cocktail waitress was invented.

Once again the idea was inspired by the vacuum tube. It had been discovered in some tubes, often large power types, that the distance to the plate was too great to attract enough electrons past the negative influence of the control grid. So another grid coil of fine wire was inserted between the first grid and the plate. This was called the screen grid and carrying a highly positive charge, it functioned as a "bait" for the plate.

In a properly designed power tube such as an EL84 or a 6V6, the windings of the screen grid are precisely aligned to fall in the shadow of the control grid. This way the electrons responding to the pull of the screen grid are lined up in sheets as they pass between windings of the inner control grid... only to find that they have been fooled! Once past the control grid and drawn toward the screen grid, they discover...there's almost nothing there. The path they're on has them aligned to zing straight through the spaces BETWEEN screen grid windings. So rather than a close and personal encounter, they just fly on past - and once they're out that far, there's no

ON TRIODES, PENTODES & IRISHMEN: (Continued)

PENTODES: (Continued) stopping them. The influence of the plate takes over and - being solid metal and of the highest positive attraction - it is at this final destination that the electrons congregate.

Thus the proper cocktail waitress - visible through the louvers - is scantily clad so as to be all the more effective at reinforcing the attractive influence of her bar and by being located in between the door and the bar, she serves as bait to lure customers past the door's negative influence. Once through the door however, it is the rare Irishman who actually comes in personal contact with the cocktail waitress as, for all intents and purposes, she - like the screen grid - turns out to be a vanishing illusion. Yet, having come this far, the solid influence of the bar itself now takes over and attracts the customers to congregate, having happily reached their destination.

If you're still following this and haven't lost track of the count, you'll know we're still one element short of the five needed to make a Pentode. This last part is a pair of beam-confining shields which being negatively charged, serve to direct the flow right toward the plate. This is much the way a short entrance hall to the bar prevents wandering accidentally into the Men's room on the way.

Once at the bar though, the circuit is complete and the process of soul-nourishing works its ritual magic. Biases having been overcome, illusory nightingales having vanished, the spirits truly soar and the once surly Irishmen now are filled with warmth, wit and kindred friendship, enjoying the music and glowing nicely with their heaters on.

With appreciative thanks to the inhabitants of the Land of the Leprechaun, we have now concluded our little diversion into the mechanics of proper bar lay-out.

A feature article by Randall Smith
Designer / President

MESA/BOOGIE

The Spirit of Art in Technology

Thank you for trusting MESA/Boogie to be your amplifier company and we wish you many years of toneful enjoyment from this handbuilt all tube instrument.

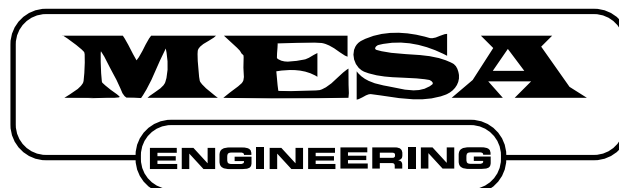

The Spirit of Art in Technology



(707) 778-6565 FAX NO. (707) 765-1503

1317 Ross Street Petaluma, CA 94954

USA