

MESA/BOOGIE



Owner's Manual

Greetings from the Home of Tone

Congratulations on your choice of the Rectifier Pre as your Guitar amplifier and welcome to the MESA/Boogie family! As a discriminating player you probably know that you have purchased the most comprehensive instrument for amplifying Guitar that is available. What you might not realize is that this entitles you to all the experience, resources and commitment our twenty-five years of service to musicians world wide has to offer. Our responsibility is to help you sound great! So, if at any time you feel you need help or direction, we are here for you...a phone call away.

RECTIFIER RECORDING PREAMPLIFIER

Precautions	0
Overview	1/2

Helpful Hints: RECORDING	2/3
--------------------------	-----

Helpful Hints: LIVE	3
---------------------	---

FRONT PANEL:

Instrument Input & Footswitch Jacks	4
-------------------------------------	---

CHANNEL MODES: Clean - Fat - Brit	4
-----------------------------------	---

CHANNEL MODES: Raw - Vintage - Modern	5
---------------------------------------	---

CONTROLS:

GAIN	5/6
------	-----

CHANNEL 1: Bright & Pad Switches	6
----------------------------------	---

TREBLE	7
--------	---

MID	7
-----	---

BASS	7
------	---

PRESENCE	7/8
----------	-----

MASTER	8
--------	---

PREAMP VOICING SWITCH	8
-----------------------	---

CHANNEL SELECT SWITCH	9
-----------------------	---

RECORDING OUTPUT	9
------------------	---

OUTPUT LIVE & SOLO	9/10
--------------------	------

STANDBY & POWER SWITCHES	10
--------------------------	----

REAR PANEL:

AC RECEPTACLE	11
---------------	----

GROUND LIFT	11
-------------	----

MIX CONTROL & FX LOOP	11/12
-----------------------	-------

MODERN/EXT.TRIGGER TO POWER AMP	12
---------------------------------	----

SAMPLE HOOK-UP	13
----------------	----

EXTERNAL SWITCHING JACKS	14
--------------------------	----

RECORD OUTPUT JACKS	14
---------------------	----

SETTING SIGNAL LEVELS	14
-----------------------	----

MAIN OUTPUTS	15
--------------	----

TUBE BAY	15
----------	----

FACTORY SAMPLE SETTINGS	16/17
-------------------------	-------

TUBE MAINTENANCE	18/19
------------------	-------

Feature Article: BIAS ADJUSTMENT by Randall Smith	20/22
---	-------

SPEAKER IMPEDANCE MATCHING & HOOK-UP GUIDE	23/28
--	-------

Feature Article: ON TRIODES, PENTODES & IRISHMEN by Randall Smith	29/31
---	-------

PARTS SHEET	32
-------------	----

PRECAUTIONS & WARNINGS

Your MESA/Boogie Amplifier is a professional instrument. Please treat it with respect and operate it properly.

USE COMMON SENSE AND ALWAYS OBSERVE THESE PRECAUTIONS:

WARNING: EU: permission from the Supply Authority is needed before connection.

WARNING: Vacuum tube amplifiers generate heat. To insure proper ventilation always make certain there is at least four inches (100mm) of space behind the rear of the amplifier cabinet. Keep away from curtains or any flammable objects.

WARNING: Do not block any ventilation openings on the rear or top of the amplifier. Do not impede ventilation by placing objects on top of the amplifier which extend past the rear edge of its cabinet.

WARNING: Do not expose the amplifier to rain, moisture, dripping or splashing water. Do not place objects filled with liquids on or nearby the amplifier.

WARNING: Always make certain proper load is connected before operating the amplifier. Failure to do so could pose a shock hazard and may result in damage to the amplifier.

Do not expose amplifier to direct sunlight or extremely high temperatures.

Always insure that amplifier is properly grounded. Always unplug AC power cord before changing fuse or any tubes. When replacing fuse, use only same type and rating.

Avoid direct contact with heated tubes. Keep amplifier away from children.

Be sure to connect to an AC power supply that meets the power supply specifications listed on the rear of the unit. Remove the power plug from the AC mains socket if the unit is to be stored for an extended period of time. If there is any danger of lightning occurring nearby, remove the power plug from the wall socket in advance.

To avoid damaging your speakers and other playback equipment, turn off the power of all related equipment before making the connections.

Do not use excessive force in handling control buttons, switches and controls. Do not use solvents such as benzene or paint thinner to clean the unit. Wipe off the exterior with soft cloth.

Be sure to have the warranty card filled out by the store at which it was purchased and return to *Mesa/Boogie*.

YOUR AMPLIFIER IS LOUD! EXPOSURE TO HIGH SOUND VOLUMES MAY CAUSE PERMANENT HEARING DAMAGE !

No user serviceable parts inside. Refer service to qualified personnel. Always unplug AC power before removing chassis.

EXPORT MODELS: Always insure that unit is wired for proper voltage. Make certain grounding conforms with local standards.

READ AND FOLLOW INSTRUCTIONS OF PROPER USAGE.



OVERVIEW:

Congratulations on your choice of the **Rectifier Recording Preamp** and welcome to the **Mesa/Boogie** Family! This all-tube, two rack space instrument is the latest in the legendary Rectifier line of amplifiers and after two years of intense R & D, is ready to wear the logo that signifies its status as a full blown **Recto**. This preamp is designed to replicate direct, the sound and feel of the **Dual Rectifier Solo Head** pushing a Rectifier 4x12 mic'ed up in a good room without the power amp, speaker and microphone. A huge challenge considering 75% of the ingredients historically used to achieve great recorded guitar sounds are missing! We think you will be as pleased as we are with the results upon your first direct experience with this toneful piece. As well as great direct sounds, the **Recto** pre packs all the urgent authority of its forefathers into this rack format and is an equally powerful live preamp as well. When combined with its mate, the **Rectifier Stereo 2:100**, these two create an all-tube stereo wall of crushing **Recto** aggression.

Six 12AX7A preamp tubes create the 6 modes in the 2 discreet channels. The top Clean Channel offers CLEAN, FAT and BRIT modes for three distinct styles of rhythm work. The bottom Lead channel is comprised of the three signature sounds from the **Dual** and **Triple Recto Heads** RAW, VINTAGE and MODERN.

A PARALLEL EFFECTS LOOP with a MIX Control is provided to ensure tonal integrity when using outboard processing. Buffered Stereo RECORD OUTPUTS are balanced 1/4" TRS type jacks. The LIVE OUTPUTS are also Stereo and both RECORD and LIVE outputs include the Return signal from the Effects Loop, so that processing may be printed and used live simultaneously.

EXTERNAL SWITCH jacks are provided to access the Channels and the SOLO feature remotely from an external midi controller. A trigger port for the switchable MODERN feature on the matching **RECTIFIER STEREO 2:100** or **STEREO SIMUL-CLASS 2:90** power amps is also included and ensures gain sounds will be ferocious.

A 2 button Footswitch provides instant access to the Channels and SOLO® feature for live performance applications. We've also included a cool switching feature that allows you to switch between the CHANNEL 2 VINTAGE and MODERN modes when the Footswitch is connected, giving you 3 footswitchable sounds from a 2 Channel platform!

Before we review the controls and features in more depth, we suggest taking a look at these helpful setup and tone tips.

FRONT VIEW : Rectifier Recording Preamp

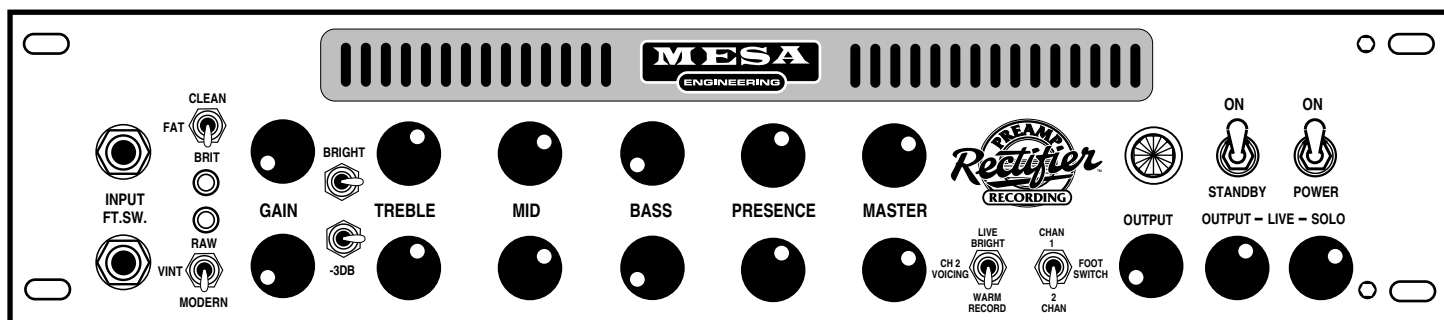

REAR VIEW : *Rectifier Recording Preamp*

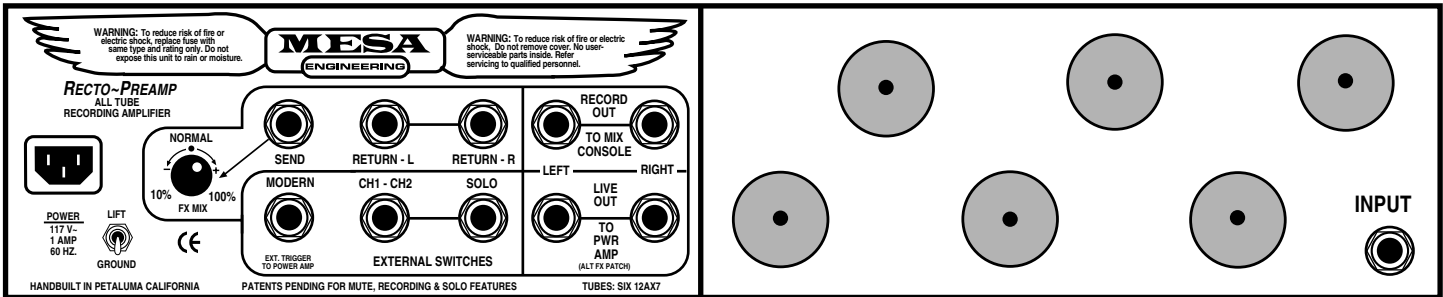

Helpful Hints:

RECORDING:

- 1) Always use the supplied A.C. Mains Cord provided and connect the unit to a grounded (3 pin) A.C.outlet. If you experience ground related hum or buzz, try lifting the Chassis Ground by selecting LIFT on the Chassis Ground switch located on the Rear Panel. Circuit to Chassis Ground (switch down) is the normal position and should be used - unless you experience a problem with this type of noise. Make sure that the A.C. cord of the **Recto Preamp** is connected to the same power strip as the Mixing Console and power amp, or powered monitors. This will help prevent hum or buzz created by different references to ground.”
- 2) Always begin sessions with the **Recto Pre** by zeroing out the Recording console Channel Input Trim and Output Fader as well as the Preamp’s RECORD Output Level Control. This preamp is capable of output levels in excess of what some consoles input stages are designed to accept. Following this simple practice will ensure that all stages of the system including the ears of you and the engineer or others in the control room, will not be damaged from an unexpected volume surge.
- 3) When nothing is connected to the EFFECTS LOOP SEND and RETURN jacks, make sure that the EFFECTS MIX control is set to 10% (all the way down) to prevent signal loss across the pot and associated LOOP circuitry.
- 4) Use high quality shielded cable of the shortest length possible for the signal between the RECORD OUTPUT jacks and the console’s LINE INPUT.
- 5) Make sure the RECORD Outputs are used for connection to the recording console.
- 6) Make sure the CHANNEL 2 LIVE BRIGHT/WARM RECORD is set to the WARM/RECORD (down) position to ensure the correct response from the 3 higher gain Lead modes.
- 7) Make sure the RECORD OUTPUT Level control is set above the “MIN” level mark on the chassis. This practice ensures the best performance from Channel 2’s three higher gain Lead modes.
- 8) If you experience unwanted breakup in CHANNEL 1 CLEAN (or FAT with lower BASS control settings) with low front end GAIN settings, try setting the CHANNEL1 Input Stage switch to -3db. This will pad the grid of the input tube and substantially increase the headroom at this pre-control stage.

NOTE: As with any system comprised of individual components, all the parts make up the whole. Remember that achieving great results with this preamp is also dependant on the equipment it is interfaced with. Consoles, power amps and most especially, the playback monitors are all part of the signal chain and therefor affect the overall tone of the sounds you are dialing. Great care was taken during the design process to use the **Rectifier Recording Pre** in different environments with a variety of systems and monitor styles and should work well with most consoles and playback monitors.

Helpful Hints: *Continued*

If you have less than satisfactory results with this instrument after reading the manual and believe it to be operating normally; we suggest either trying some different playback monitors or, taking it to your nearest dealer to try it through a different setup. In our tests we have found the playback monitors to be a huge part of the equation and that some are not very friendly to overdriven guitar sounds.

LIVE:

1) Always use the supplied A.C. Mains Cord provided and connect the unit to a grounded (3 pin) A.C. outlet. Make sure that the A.C. cord of the **Recto Preamp** is connected to the same power strip as the power amp or Live Mixing Console it is feeding. This will help prevent hum or buzz created by different references to ground. If you experience ground related hum or buzz, try lifting the Chassis Ground by selecting LIFT on the Chassis Ground switch located on the Rear Panel. Circuit to Chassis Ground (switch down) is the normal position and should be used unless you experience noise of this type.

2) Use high quality shielded cable of the shortest length possible when connecting the LIVE OUTPUTS to your power amp.

3) Make sure the LIVE Outputs are used when connecting to a Stereo power amp for live applications.

4) Use one of the 4 all-tube **MESA** Stereo Power amplifiers (preferably combined with **Mesa** speaker cabinetry) for live applications. These rack mount power amplifiers were designed specifically to create the other half of a great guitar amp rig and will ensure the best performance with the **Rectifier Preamp**. The choices are; **Rectifier Stereo 2:100**, **Stereo Simul-Class 2:90**, **Stereo 2:50** and the **Stereo 20/20**.

5) Make sure the CHANNEL 2 LIVE BRIGHT/WARM RECORD switch is set to the LIVE BRIGHT (up) position. This ensures that circuitry devoted to rolling out unwanted frequencies for the RECORD Outputs will be replaced by circuitry that enhances dynamic attack for live applications at the LIVE Outputs.

6) The SOLO Control is not activated until the Footswitch is connected to the Footswitch jack on the Front Panel.

7) The SOLO Footswitchable Boost feature is capable of settings higher than that of the OUTPUT Level and can not be set below the OUTPUT Level's setting.

8) CHANNEL 2 can be set up to achieve 2 footswitchable sounds (VINTAGE & MODERN) for live applications however, this option defeats the SOLO feature. Here's how:

*Select MODERN (lower position) on the CHANNEL 2 Mode switch. Connect the Footswitch to the Front Panel Footswitch jack using the provided stereo cable. Use the CHANNEL button on the footswitch to toggle between CHANNEL 1 & 2. Use the SOLO button on the Footswitch to toggle between VINTAGE & MODERN Modes in CHANNEL 2. Use the CHANNEL 2 Master for the MODERN Mode Master Volume Control and the Solo Control to control the volume of the VINTAGE Mode.

NOTE: The best results will be achieved for this live scenario by using the companion power amp, the **Rectifier Stereo 2:100**, and connecting the MODERN trigger jack on the Rear Panel of the **Rectifier Preamp** to the MODERN trigger port on the Rear Panel of the power amp. This scheme recreates the **Recto** sound in its authentic form because the negative feedback is removed at the power amp when MODERN is selected on the preamp. This tracking of power styles is identical to that which occurs in the **Dual & Triple Rectifier Heads** and is crucial to the performance of these Lead sounds.

Now that we have some of the useful tips covered, let's move on to understanding the controls and how they interact to create the sounds you want to hear.

FRONT PANEL CONTROLS:

INPUT / FT.SW.

First remove the protective covers from the tubes (plastic webbing) before connecting the A.C. cord to a power receptacle.

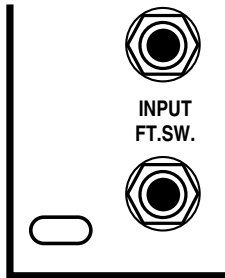

INPUT: Connect your favorite guitar to the instrument INPUT jack. Flip the POWER switch to the ON position while leaving the STANDBY switch set to STANDBY." (It is always a good idea to practice this start up procedure as at least 30 seconds of warm-up time lessens the shock on cold tubes, thus prolonging their life substantially.)

FT.SW. Connect the **Recto Pre's** Footswitch to this jack, which will allow you to toggle between channels remotely. Use only the supplied footswitch and stereo cable when connecting to this jack.

THE CHANNEL MODES:

CHANNEL 1:

CLEAN: This is the lowest gain circuit of the 3 Modes in CHANNEL 1 and is optimized for producing balanced pristine clean sounds. For the best understanding of how to achieve a great sound in this mode, please refer back to the GAIN Control section of this manual. However, a great place to start is 12:30 or so on the GAIN Control with more sparkle available below this and more warmth apparent above...from there adjust according to your guitars individual response.

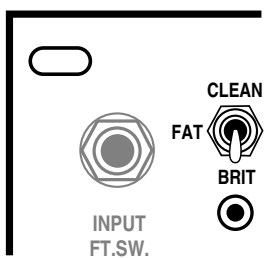

Because of its more traditional architecture, this mode also works extremely well for vintage style drive sounds in live (power amp) applications. By turning the gain all the way up, a beautiful old school solo sound is possible...especially with neck single coil pick-ups. The TREBLE and MIDDLE Controls can also add gain and sustain to this sound (reduce Presence to blend highs), but you will probably want to run the BASS Control below 10:30 to avoid flubbiness and preserve a focused attack.

FAT: This mode comes from our original **Mark 1 Boogie** and puts emphasis on the low mid and bottom end and as a result the top strings of the instrument have more girth and width. The difference is wonderful for clean single note soloing where you need more body and warmth behind the notes. Because this mode is very different from the CLEAN mode, it requires that you reset the controls for balance. We suggest running the BASS Control a couple notches lower, especially for chording.

It also helps to use the GAIN Controls' tonal influence (refer to GAIN in the Controls section of this manual) to achieve the best results with this mode. We like to set the GAIN somewhere between 10:30 and 12:00 for chording as this brings out the sparkle and improves the headroom. For single note clean soloing you can run the GAIN up around 1:00 - 2:00. If you are going for a pushed rhythm sound with the GAIN all the way up, you will likely have to run the BASS below 9:30 to avoid flubbiness and boom.

BRIT: This mode was inspired by the great sounding amps of the 50s' & 60s' that were built in Great Britain. These classic amplifiers were basically "upside down Leo circuits" but none the less had a signature sound all their own, due largely to the fact that they were powered by the pentode available to them at the time...the Euro style EL 34. However, the preamp sections of these classics were also different and here in the **Recto Pre** they have been distilled down to a very different and useful rhythm mode. With emphasis on a lower region of Treble and more punch in the low mids, this mode is truly different than the other modes in CHANNEL 1 It works extremely well for both chording and single note soloing with its thicker throatier nature. It also lends itself well to clipped sounds when used live with a power amp, with its less extended top end and wider mid section, that produces some of the coolest crunch rhythm sounds around in the LIVE applications. For Direct applications it may be necessary to run the TREBLE and PRESENCE a little lower. The circuitry used to preserve the beautiful clean sounds of CHANNEL 1 can put too much emphasis on the upper harmonics and when BRIT is used with max-ed out GAIN settings, can sound thin and buzzy without the roll off that occurs in the CHANNEL 2 Direct circuit.

FRONT PANEL CONTROLS: *(Continued)*

CHANNEL 2 MODES:

RAW: This **Recto** mode is the lowest gain of the three in CHANNEL 2 s' high gain lead channels. Its less saturated nature greatly enhances the already versatile bevy of sounds the two original lead channels offered. The range of gain available covers an extremely wide spectrum and it can be set to double as a formidable alternate clean mode, a low gain purring blues sound and beyond, all the way up to a grinding crunch or searing solo sound. The TREBLE can be set relatively high (2:00) to add a little more gain and shred when using RAW for certain crunch rhythm sounds. Don't overlook the amazing medium gain soloing potential RAW offers in CHANNEL 2 where, because of its more gradual and responsive GAIN taper, a wide range of voice like single note solo sounds appear that benefit from this more compressed, less saturated character.

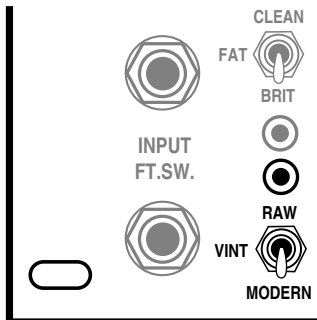

VINTAGE: This high gain mode is the famous liquid **Recto** voice and it can be found in its original state in CHANNEL 2. Its lush harmonic content and fat creamy feel has found its way on to so many recordings, it is now a staple for anyone headed to the studio for an album project. Single note solo work is effortless as the strings become easy to play with VINTAGE modes musical and natural tube compression.

Spend time learning the lower regions of the VINTAGE mode as the overlap between RAW and VINTAGE is a place where many beautiful sounds lie. These two modes are similar enough when VINTAGE is set in its lower range and RAW is set in its medium to higher range, and yet each possesses a character that is unique and identifiable.

MODERN: Aggressive. This is the word that best describes the menacing power of the **Rectos** most rebellious of all modes and appears in its original form in CHANNEL 2. A take no prisoners, crushing assault of top end cut and lightning fast response creates a sound of unparalleled aggression that has set a new standard for hard core sounds. The added tightness of the low end response combined with the radically more present top end keeps the MODERN mode tracking accurately even at extreme gain settings.

NOTE: Keep in mind that the CHANNEL 2 MODERN experience can be further enhanced in a LIVE application by using the companion power amplifier, the **Rectifier Stereo 2:100**. By connecting the EXT. TRIGGER MODERN jack on its Rear Panel to the **Recto Preamps'** MODERN trigger jack the power amp will track the preamp MODERN mode and auto-remove the negative feedback every time you select MODERN on the preamp. This scheme duplicates the sonic authority as it recreates the exact circuit of the **Dual Rectifier Solo Head** in this rack mount platform.

NOTE: There is a slight volume drop when switching between CHANNEL 2s' VINTAGE and MODERN modes when you are using the RECORD OUT jacks connected to a console. This is a result of having to recreate the sound of the MODERN mode without a power amp to remove negative feedback from. We duplicated the sound by notching the same frequencies that become recessive in the re-voicing that occurs in the solo heads when the negative feedback is removed and are pleased with the results of this challenging task. The sound has been created here without the unruly power section and the only thing **Recto** head owners may have to get used to is not getting blown out of the room as you flip to MODERN. And if you just can't get used to the well behaved operation direct, you can always connect up the companion power amp and follow the above NOTE and blow yourself down.

THE TONE CONTROLS:

GAIN: Like most amplifiers, the GAIN Control in each channel determines its sensitivity and overall tonal characteristics. It meters the amount of Gain that your guitar signal will produce. In the **Recto Recording Preamp**, we paid special attention to the amount and frequencies of gain present in each mode, making sure the whole range of available gain is musically usable. We also worked diligently with our suppliers to develop pots with tapers useful to players that require that touch sensitive relationship of input signal level to gain saturation. An essential ingredient to a great amps expressive nature. To maximize your expression, spend time learning the different regions of the GAIN Control in each mode and tonal colors they enhance. Almost more - or certainly equal to the tone controls - the GAIN Control shapes your sound.

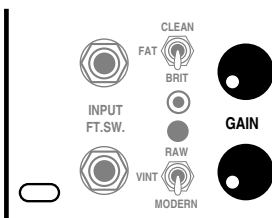

FRONT PANEL CONTROLS: (Continued)

GAIN: (Continued) As a general guideline, the lower regions of this control produce brighter, tighter, faster sounds with enhanced dynamics...the higher the GAIN Control setting - the warmer, fuller, more saturated and more compressed (less dynamic) the sound becomes. Remember that with this sensitive control the entire character of the channel is determined. Because the **Recto Recording Preamp** is a hyper-tuned gain machine some of the best and most musical sounds are found in the middle ranges of this control. In other words...more is not always better.

CHANNEL 1 BRIGHT & INPUT PAD:

These two recessed mini toggle switches are CHANNEL 1 specific and offer a couple of choices for how this channel can be configured to achieve the perfect clean sounds with your individual style and choice of instrument.

BRIGHT: (Upper Switch)

This switch provides two voicings for the 3 modes of CHANNEL 1, NORMAL and BRIGHT so that you can tailor the upper harmonics to the style you are playing. This switch can also be used to either add the sparkle to a flat sounding guitar or, roll off unwanted brightness for a warmer, jazzier sound. The switch operates left to right and selecting the (left) NORMAL position defeats the BRIGHT circuit, offering a round, warm voice that is great for jazz sounds or single note solo work where the fattest response is desired. Selecting the (right) BRIGHT position engages circuitry that accentuates the upper harmonic region and adds an upper extension to the sound. This region of frequencies is much higher than those affected by the TREBLE Control and they open up the sound, making it more three dimensional and breathing. We tend to prefer the BRIGHT (right) position due to this more open and transparent quality, even for jazz or solo sounds. It is often preferable to retain these higher, sparkling frequencies and roll out the lower, and sometimes harsher, ones with lower settings of the TREBLE and PRESENCE Controls to produce a sound that is sweet and warm.



On the other hand, use the BRIGHT switch set to the NORMAL position to create a more traditional, less enhanced clean sound when connecting directly to a console. Because near field monitors can often sound too bright and traditional clean sounds have often been achieved by mic'ing up favorite old cabs, the rounder voice of the NORMAL (left) position can be very helpful in creating a sound with more girth and less sparkle.

-3db PAD:

This (lower switch) mini toggle provides a pad for CHANNEL 1 and can be used to clean up the signal for ultimate clean sounds when using the **Recto Pre** direct into a recording console. The left position is NORMAL and allows the full strength signal of your instrument to be fed to the input tubes first stage. The right position activates a - 3db Pad and knocks down the signal strength fed to this first stage by this amount.



Again, because near field monitors can be like putting a microscope on your sounds, the subtle and normally undetectable breakup or overdrive you've probably been living with as your live clean sound, is far less soulful in the direct environment. This switch puts a - 3db Pad in line with the input so that the signal is padded before it hits the grid of the input tube. Because this pad occurs prior to the GAIN Control, it knocks down your guitars' signal strength, much like turning down the volume pot. In fact, if you don't mind the change in sound with your guitar set low, this is another way to achieve what the pad does.

If you prefer to use this scheme, it is helpful to put a capacitor of a small value (.001pf) across the volume pot of your guitar so that you don't lose too much top end as you roll the pot down. Some will prefer this to the slight roll of that occurs when the - 3db Pad is switched into the circuit.

It is important to understand - and get a feel for - the headroom scenario at this crucial place in the circuit. If there is any clipping at this first stage, no settings of the GAIN or TONE controls at later stages will diminish or remove it. Knowing this and utilizing the - 3db Pad will help you to get a great clean sound and will save valuable time in the studio.

FRONT PANEL CONTROLS: *(Continued)*

TREBLE: As with most guitar amplifiers, the TREBLE Control is the strongest of the three rotary tone controls. Its setting on the **Recto Recording Preamp** determines the blend and strength of the MIDDLE and BASS Controls. Set high, it is the dominant control, thus minimizing the amount of Mid and Bass that would be possible in the mix. Set low, the TREBLE becomes the recessive control and a warmer, darker blend is produced. Dial with care.

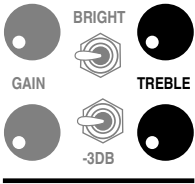

Subtle tweaking of this control tends to produce the best results.

MIDDLE : The MID Control determines the blend of midrange punch and boldness. It also has a great deal to do with how a sound feels to play. Setting the Midrange low scoops the attack, making the sound and feel more liquid and resilient. Setting the MID Control higher introduces more punch and authority, helping sounds cut through a mix better. Setting the Mids very high may make the strings feel a little stiffer and less spongy. Keep this in mind when dialing up your sounds so that you can retain the best feel on the strings, allowing you to always play your best.



In the BRIT Mode, the MID Control set low produces a sweeter, smoother clip and really allows this sound to purr. Try the GAIN Control set at around 11:00 or so and the MID Control set at around 7:00 to 9:30 for a tasty blend of smooth dynamic overdrive. Add Treble to focus the attack and fatten with the BASS

Control. Presence will “Open up” or compress this beyond vintage sound that howls with authenticity. This has to be one of the best sounds in the **Recto Recording Preamp**. At high Gain settings in either the VINTAGE or MODERN Modes, the MID Control dials in punch and aggression. For the tightest crunch chording, set the MID Control high, say around 1:00 to 2:30. To make single notes feel juicier and more liquid, reduce the MID Control to around 9:00 or so. In the MODERN Mode, using the Mid higher in conjunction with the PRESENCE Control also set high, delivers a down right ugly crunch that’s huge and angry - not fit for the meek! This setting also sounds great and becomes easier to play and more elastic feeling with the GAIN Control set at 2:00 or higher.

BASS: This control blends in the lower frequencies and its effectiveness, again, depends on the setting of the TREBLE Control. It should be set with moderation as extreme settings in either low or high directions can produce an unbalanced tone. Be “especially” careful in higher Gain settings of either channel. Too much Bass will cause a flabby unfocused sound.

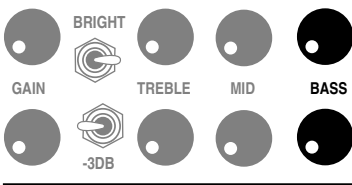

Try setting the BASS Control to 1:00 for clean sounds in the CLEAN Mode and 10:00 or below when dialing up high gain overdriven sounds in this Mode. In the LEAD Modes, try setting the BASS somewhere between 7:00 and 2:00 . These settings will vary with the amount of Gain and Treble you have dialed up.

PRESENCE :

These rotary controls adjust the brightness above that of the TREBLE frequency wise, and allow you to fine-tune the upper harmonics to suit the style you wish to play. In CHANNEL 1 it can be used to open up the sound when set in its upper region - adding a chiming, bell like quality that also feels as if headroom has been increased. Set low in CHANNEL 1 the sound becomes rounder and less pointed or even compressed, which is desirable for traditional rock or roots style rhythm work. With the PRESENCE all the way down a beautiful jazz sound can be found and though this may seem out of place coming from a line of amps best known for high gain grinding, don’t underestimate the power of CHANNEL 1 for studio clean sounds of any style.

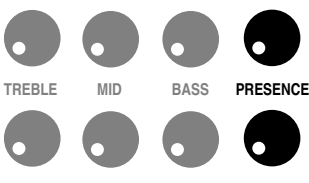

FRONT PANEL CONTROLS: *(Continued)*

PRESENCE CONTROL: (Continued) CHANNEL 2 PRESENCE is extremely important in achieving the desired lead and crunch rhythm sounds. It responds like a focus or spread control for high gain chording sounds and for solo sounds it does a great job of compressing or putting the sound forward. When using high gain chording sounds run the PRESENCE from roughly 12:00 to 5:30 and check out how it spreads the upper harmonic region out like a fine sauce. We like to set it so there is a nice haze, but not a harshness to the grind. For lead work try the PRESENCE from around 9:30 to 2:00 and notice that there will be a sweet spot where the sound is still open, but also has a thick creamy character. The lower region often feels easier to play - as the sound can become pointed or peaky as the PRESENCE frequencies become too dominant in the mix.

NOTE: In CHANNEL 2 the PRESENCE will seem to react different in the MODERN mode from the way it does in the RAW and VINTAGE modes. This occurs because the MODERN mode accentuates the top end radically and since there is more of these frequencies coming into play earlier in the preamp, the PRESENCE has more to boost in this mode. Don't be surprised if you find yourself re-dialing the PRESENCE drastically when you jump between these modes.

NOTE: When using the RECORD OUT jacks to interface to a mixing console be mindful that the PRESENCE can be very instrumental in achieving a sound that is balanced and feels good to play. The setting of the PRESENCE can be critical in high gain lead sounds in CHANNEL 2, especially if the playback monitors have bright tweeters. We have found that, in general, lower PRESENCE settings work better for high gain sounds when running direct.

MASTER: A simple control found on most amps today, these serve to balance the playing level of the two channels. They enable the pre-amps GAIN Control to be used in a wide range of settings, while never having to affect the listening level. On the **Rectifier Recording Preamp** these MASTERS serve another purpose as well. When the FX LOOP is in use, these MASTER Controls double as Effects Loop Send Level Controls.

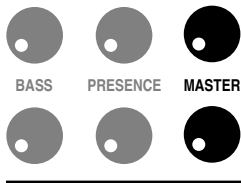

This is not their primary function, but the setting here does affect the channels' Send strength. We have found the middle ranges 9:00 through 2:00 to be vary well behaved for most effects. Setting the MASTERS in this region should make for trouble free effects interfacing when using the loop.

NOTE: You have probably noticed that there is a MIN symbol at 9:00 on the CHANNEL 2 MASTER Control. This is to indicate the minimum level the MASTER Control should ever be set to when using the RECORD OUT in a direct recording scenario. When using the LIVE OUT jacks connected to a stereo power amp, the associated circuitry is not involved and you may set the MASTER Control lower if you wish. This pertains to CHANNEL 2 only because there is a huge amount of circuitry dedicated to achieving the signature Rectifier high gain sounds in this direct domain. With the MASTER set below this point in CHANNEL 2, overdrive sounds will become thin or buzzy and lack richness in the RECORD OUT Direct circuit. Be sure to follow this scheme when first setting up for direct recording to ensure optimum performance from these amazing high gain modes.

PREAMP VOICING: LIVE BRIGHT / WARM RECORD

This self-explanatory switch is at the very heart of the proverbial beast. It determines whether the signal is run through the direct circuit for radical re-shaping to accommodate consoles and monitors or - left alone with brightness intact to interface with our all-tube stereo power amplifiers and guitar speakers. The shaping that occurs in each of the positions is critical to the performance in each of these very different and opposing environments. This global switch demands that you dedicate the preamp to be optimized for either a live or a direct application. You may use the preamp with both LIVE OUT and RECORD OUT jacks feeding their respective sources, but you will have to choose which sound is more critical for your situation and compromise on the other. May we suggest that if you are doing a live recording with a band and need the recording to be as good as possible without overdubbing, select WARM RECORD and increase the PRESENCE on the power amp for your live cabinets. The live environment is probably infinitely more forgiving than the direct environment and the direct RECORD OUT sound suffers dramatically without the treatment that occurs in the WARM RECORD mode.

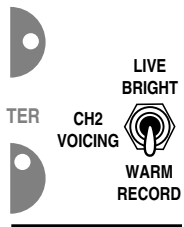

* Use LIVE BRIGHT anytime you are playing live through a dedicated guitar power amp and guitar speakers

* Use WARM RECORD anytime you wish to record direct using the RECORD OUT jacks connected to a console or recorder.

FRONT PANEL CONTROLS: *(Continued)*

CHANNEL SELECT:

This three position mini toggle selects which of the two channels is active when the footswitch is not in use. It is located in a convenient Front Panel location to make channel selection easy in the studio where it might likely be hardwired in to a system or patch bay. Set in its center FOOTSWITCH position with the footswitch connected via a stereo cable, the channels may be accessed remotely by toggling between them with the FOOTSWITCH CHANNEL button.

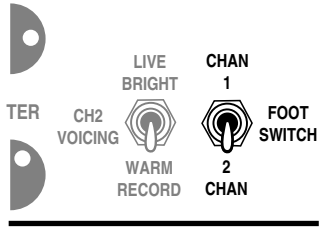

RECORDING OUTPUT:

This control determines the amount of signal present at the pair of RECORD OUT jacks located on the Rear Panel. The range is optimized for the LINE INPUT stage of recording consoles. There is more than enough signal strength to overload a console's input at the upper end of the RECORDING OUTPUT Control, so we suggest running the control in the middle to lower range, 9:00 - 2:00. This control uses a ganged element potentiometer so that one control can handle the level for both RECORD OUT jacks. At very low settings (9:00 and below) it is normal for the calibration to vary slightly between the two elements in the pot and create a level difference between the LEFT and RIGHT RECORD OUT jacks. Staying within the optimum operating range (9:00 - 2:00) will prevent this quirk. If for some reason like when (CHANNEL 1's GAIN cranked) you must use the RECORDING OUTPUT set very low and this level difference is a problem, simply adjust the input trim control or channel slider on the console until the two RECORD OUT levels match.

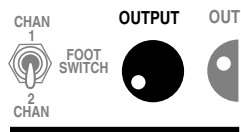

NOTE: It is always a good practice to begin every session by zeroing out the RECORDING OUTPUT (and LIVE OUTPUT) before turning up the monitoring levels. Avoid damage to unwary ears and/or mixer input stages with this simple habit and your friends and engineers will thank you.

OUTPUT - LIVE:

This control adjusts the level present at the LIVE OUT jacks located on the Rear Panel. It has been optimized to interface with the inputs of our four all-tube stereo power amplifiers. Like the RECORDING OUTPUT, the pot used here also has a dual element so that one control can handle both LEFT and RIGHT LIVE Outputs. This scheme allows you to configure the channels with the desired modes and then control the overall level of both the relative channels, and the stereo outputs with one control.

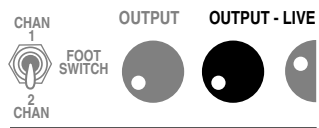

SOLO - LIVE:

This control is activated by connecting the Footswitch to the FT. SW. jack on the lower left of the Front Panel. It is an additional level control wired in parallel with the OUTPUT Control and provides a footswitchable boost for use in LIVE applications. This feature works in both channels and in all Modes since it is wired in parallel with the OUTPUT it can only be set to achieve a level higher than that of the OUTPUT and not below. The SOLO® feature is triggered when SOLO has been selected on the Footswitch after it has been connected via the provided stereo cable. Use this feature to provide two levels of the same sound or to step out for increased volume during solo passages.



As mentioned earlier in the HELPFUL HINTS - LIVE section of this manual, there is another application for the SOLO Control. It is possible in Live applications to switch between the VINTAGE and MODERN Modes in CHANNEL 2 and have 3 footswitchable sounds out of this 2

FRONT PANEL CONTROLS: (Continued)

LIVE - SOLO: (Continued) Channel format. The controls will affect both sounds, so you will not be able to dial up independent Channels, but when used with the companion power amp (**Rectifier Stereo 2:100**) this little trick can be quite effective. This “smart power” amp tracks the preamp mode and switches the negative feedback circuit to match the Mode in use on the **Recto Pre**. In this scheme, the SOLO Control is switched to a different part of the circuit where it ceases to be a parallel OUTPUT and becomes a separate MASTER volume for the VINTAGE mode. You lose the ability to have the SOLO feature, but you gain an additional sound you can footswitch to.

NOTE: It is not possible to use SOLO in the MODERN Mode. We opted for the 3 MODE LIVE feature over being able to trigger SOLO in the MODERN Mode for obvious reasons. If you find that you never use or need the 3 MODE LIVE feature because you do not use VINTAGE in your live application; it is possible to modify the circuit to defeat this option and give you access to the MODERN Mode with the SOLO feature. Call our Customer Service department and a Product Specialist can send you a diagram that will enable you or a technician to remove this feature. However, before you do this, may we suggest trying the 3 MODE LIVE feature and make sure that this won't come in handy for you in a future musical situation. Follow these steps to reconfigure the SOLO feature to create a 3 Mode scenario;

- 1) The FOOTSWITCH must be connected via the stereo cable to the Front Panel FT.SW. jack.
- 2) Connect the LIVE OUT jacks to the **Recto Preamp** Inputs of the **Rectifier Stereo 2:100** power amplifier and connect your cabinets to the proper impedance Speaker Output jacks. (You may use other **Mesa**, or even non **Mesa** power amplifiers, however the MODERN mode will not be the sound of the **Dual Rectifier Head** because only the **Rectifier Stereo 2:100** has the mode tracking feature.) The **Stereo Simul-Class 2:90** has a switchable MODERN feature but the sound of this power amp is smoother and less aggressive and will not duplicate the sound of the MODERN mode as it is found in the **Solo Heads**.
- 3) Connect an unshielded cable from the MODERN EXT. TRIGGER TO POWER AMP jack located on the lower left of the **Recto Pre** Rear Panel to the MODERN EXT. TRIGGER jack on the Rear Panel of the **Rectifier Stereo 2:100** (or **Stereo Simul-Class 2:90**). Caution! If the preamp is in CHANNEL 2 MODERN mode when you connect this cable, the volume will jump dramatically as the negative feedback is triggered off.
- 4) Select MODERN in CHANNEL 2 and set the level with the Channel MASTER to the desired level. Select SOLO on the Footswitch to trigger the VINTAGE Mode and set the desired level with the SOLO Control.
- 5) Use the CHANNEL button on the Footswitch to toggle between CHANNEL 1 and 2 and the SOLO button on the Footswitch to toggle between MODERN and VINTAGE modes.
- 6) To Review; The CHANNEL 2 MASTER Controls the level of the MODERN mode and the SOLO Control becomes the master for the VINTAGE mode.

This ability to reconfigure the way the SOLO Control operates greatly enhances the possibilities for live performance applications. We suggest that you try this scenario at some point if for no other reason, than to educate yourself on the dramatic effect negative feedback has on the tone in a power section. The removal of it creates an explosive, dynamic and very forward and powerful sound that should be experienced at some point by all tube aficionados.

STANDBY: Perfect for set breaks... this toggle switch also serves an even more important purpose. In the Standby position the tubes are at idle so that during power up they may warm up before being put to use. Before Power is switched on, make sure the STANDBY switch is in the Standby position. Wait at least 30 seconds and then flip the STANDBY switch to the ON position. This prevents tube problems and increases their toneful life substantially.

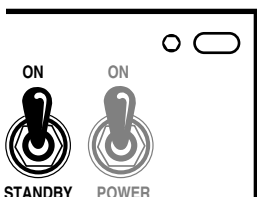

POWER: This switch delivers the A.C. power to the **Recto Pre**. Follow the cold start procedure described in the ON/ STANDBY section above when powering up your new **Recto Pre**.

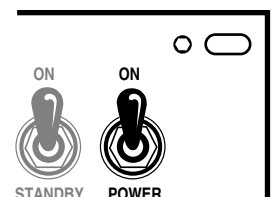

REAR PANEL CONTROLS:

REAR VIEW : *Rectifier Recording Preamp*

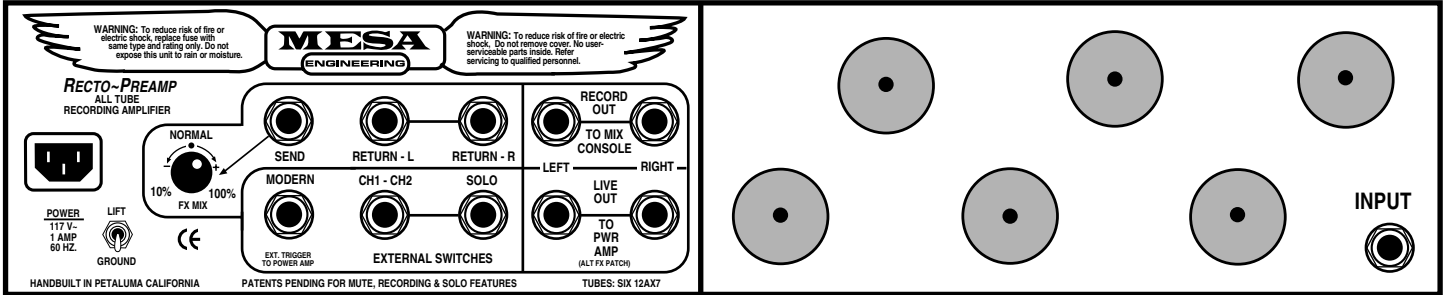

A.C. POWER RECEPTACLE: The total power consumption for the **Recto Pre** is 1Amp @ 117 Volts. Thus, a 15 Amp circuit (which is what most house circuitry is wired with) is adequate. Make sure the Euro style A.C. power cord is firmly seated in the power receptacle before powering up the unit. Always connect the A.C. cord to a 3 terminal grounded socket. If none are available, connect the A.C. power cord to a ground lift adaptor and then connect to a 2 terminal outlet. This may also be necessary from time to time for ground related noise problems.

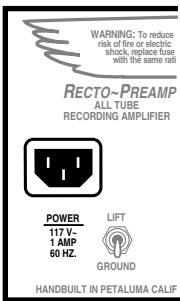

This style of power cord will make tear-downs and cable routing a lot easier and save you time as well. If you should ever need a replacement, just call and we'll be happy to send you another one for a nominal charge or visit your nearest **Mesa/Boogie Pro Center**.

GROUND LIFT: This mini toggle lifts the circuit ground from the sheet metal chassis ground. Normally the ground of the circuit is connected to the chassis ground such that there is one common ground. In certain rack applications, whether it be in live rack systems with multiple pre-amps in use, or in a studio environment where the **Recto Pre** is connected to a console, the common ground scenario actually creates a ground loop. By removing the circuit ground from chassis ground this annoying hum can often be eliminated. There is no right way to use the **Recto Pre** (grounded or lifted), but if you do not experience any ground related noise it would be preferable to use the unit in the **GROUND** position (toggle down).

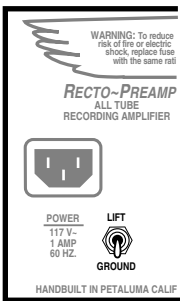

NOTE: It is usually preferable to connect the Preamp A.C. Power cord to the same power strip as the mixing console (or power amp in live applications) to minimize the possibility of a ground loop and related hum or noise.

MIX CONTROL & EFFECTS LOOP: The **Recto Pre** handles external signal processing in the same way that most recording engineers do in a pro studio environment. A dry signal (track) is the main source and a second signal is created in parallel, sent through the desired processing and then mixed back in on a separate fader to insure the articulation and clarity of the original signal or track. The **Recto Pre's** **LOOP** consists of a mono 1/4" **SEND** and a pair of 1/4" **RETURNS** which are labeled **LEFT** and **RIGHT** and a rotary **FX MIX** Control. The **SEND** is the main source and the **RETURNS** become the patch point for the parallel wet (effected) signal. The rotary control (like the second signal faders in the studio) determines the amount of the wet (effects) signal that gets mixed with the dry (un-effected) signal. In this way you can choose to run your signal very wet or keep the signal virtually untouched by the effects, thereby retaining the most articulate and urgent sound and feel.

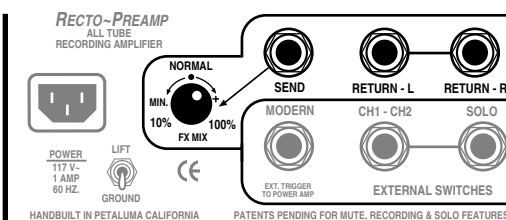

REAR PANEL CONTROLS: (Continued)

FX MIX CONTROL & EFFECTS LOOP: (Continued) The MIX Control has a range that roams between 10% and 100% of the wet blend. It is not possible to completely remove the parallel signal from the EFFECTS LOOP path with the FX MIX Control (this is due to a decision made by us to preserve the maximum tonal performance while the LOOP is in use). Connect your processors in the following manner as illustrated on the following page: If your processor is a mono device or, you simply wish to process only one side of a stereo harness - you may choose either of the **Recto Pres'** EFFECTS LOOP RETURN jacks (LEFT or RIGHT) as they both process the same sound. Just be sure to keep your channels straight as you continue on down the signal chain to the power amp. Once a signal has been fed to the EFFECTS LOOP SEND jack, the unused RETURN jack will not produce a signal at its corresponding MAIN or RECORD OUTPUT jack.

NOTE: When the PARALLEL EFFECTS LOOP is not in use and nothing is connected to the SEND and RETURN jacks, make sure the EFFECTS MIX Control is set to 10% (counter-clockwise to stop). This setting ensures the best tone and output gain is possible at all times. If you use your **Recto Pre** hardwired into the same system all the time, this will not become an issue. However, if you carry the **Recto Pre** to different studios separately or take it in and out of your rig frequently, it is a good practice to mark your EFFECTS MIX Control setting with a grease pencil and "zero-out" this control every time you disconnect your processors. Although the **Recto Pre** will still produce great sound even if this advice is not followed, attack response characteristics and output levels will be compromised.

Though the **Recto Pres'** EFFECTS LOOP is the best type for a guitar s product to preserve the inherent attack characteristic and overall sound quality and no expense was spared in its development, our tests have resulted in some interesting findings. We have had the best sonic and tactile results by actually bypassing the EFFECTS LOOP altogether and patching outboard gear directly between the pre-amp and the power amp with short, good quality cables.

Though this may seem in many ways contradictory to the very concept of - and reason behind - a parallel effects loop...in repeated test situations we found the sound to be more three dimensional and full of punch, body and life than that of the same processing used in the EFFECTS LOOP with equivalent cable lengths. Theoretically (and electronically) this does not make good sense - and in fact should actually cause greater degradation of tone due to the more sensitive impedances present at the MAIN outputs. Nonetheless, being the tone-first-theory-later design team we have come to be, this patching scheme has worked much to our favor. We have long felt this to be true and in fact included this tip in some of our other products' owners manuals. To verify our findings we recently took a census of TriAxis (Programmable Pre-amp) users among our phone-in customers and touring artists and found that most used their processing between pre-amp and power amp, saving their effects loops for more specific switchable applications. When asked why, in almost every case they said they liked the sound better between the pre-amp and the power amp. So try both ways for your specific application and choose the one that fits your ears and patching requirements best. There is no right or wrong way to interface processing to your **Recto Pre** so experiment at will.

NOTE: If you intend to record with the **Recto Pre's** Direct RECORD OUTPUTS and you wish to use the same processing you use in your live rig and print it to a track (s) - you will need to feed the processors from the RECORD OUTPUTS, not the MAIN OUTPUTS. From there you will need to connect either one (or both if stereo) of the processor's OUTPUTS to the console's LINE INPUTS. The signal should be of a adequate level and the blend should be close to what you are used to in your live rig.

MODERN / EXT. TRIGGER TO POWER AMP

As described earlier in the Front Panel section of this manual under SOLO, this is the trigger port for the auto-tracking MODERN feature. This jack sends a trigger pulse to the corresponding jack on the **MESA Rectifier Stereo 2:100** and **Stereo Simul-Class 2:90** power amplifiers.

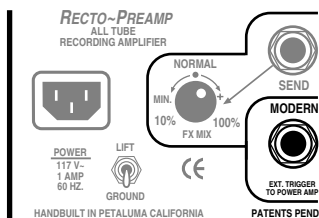

These smart power amps auto-modify the amount of negative feedback when the MODERN mode in CHANNEL 2 of the preamp is selected or switched to via the Footswitch. This reshaping is crucial to the sound of this mode and using this feature duplicates the circuit and the performance of this punishing mode in the **Dual & Triple Rectifier Solo Heads**.

SAMPLE HOOK-UP

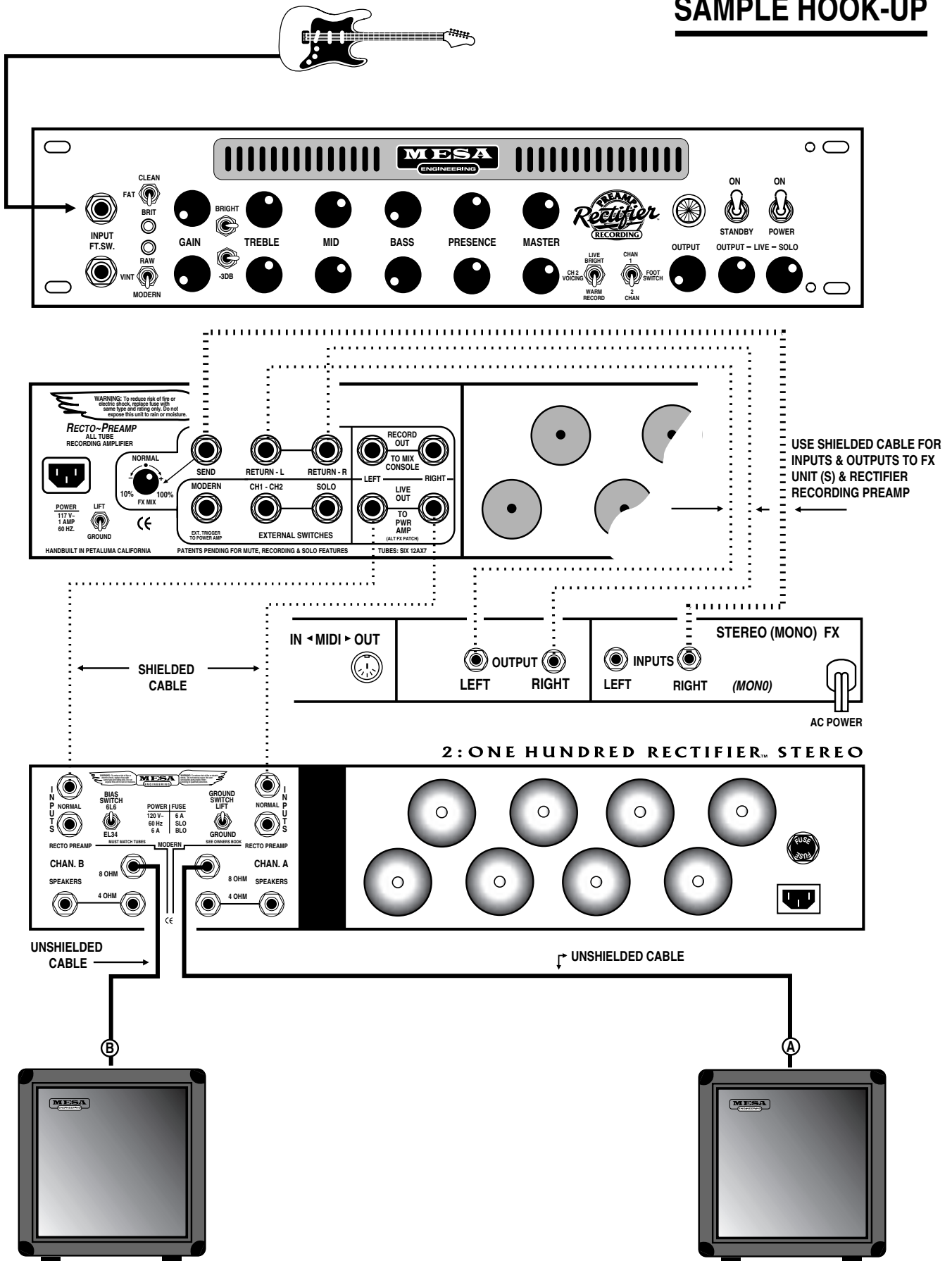

REAR PANEL CONTROLS: (Continued)

EXTERNAL SWITCHING JACKS: These three 1/4" jacks make it possible to trigger the two channels of the **Recto Pre** with an external switching device so that it can be used in a midi controlled rack system. In this scheme the channels can be called up under midi programs.

The jacks respond to any tip-to-ground latching type switch logic. The Front Panel CHANNEL SELECT toggle switch must be in the center (FOOTSWITCH) position for the EXTERNAL SWITCH jacks to respond to the external switching source.

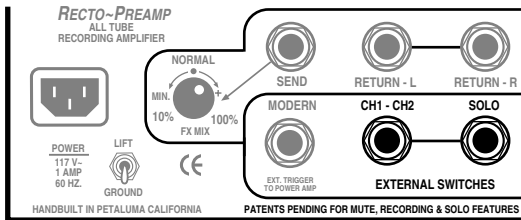

RECORD OUTPUTS: This is the stereo pair of outputs to a recording console or a live mixing board for Direct applications. The two jacks provide a BALANCED output and this is achieved by using stereo jacks that are wired as standard TRS (Tip, Ring, Sleeve).

The signal level is controlled in tandem (for both jacks) via the dual element RECORDING OUTPUT Control on the lower right of the Front Panel. The signal level range and output impedance is matched to meet the needs of this environment and should provide seamless interfacing for all your direct needs. These outputs represent years of R & D and substantial circuitry devoted to recreating the sound and feel of a live power amp driving guitar speakers, without any of these crucial components involved. We think you will be extremely pleased

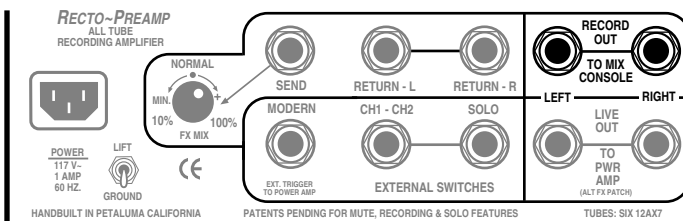

with the results of these tailored outputs and will find as we, and the players we know have, a new and inspirational way to get keeper tracks fast and accurately...putting the spontaneity back into the mix.

As mentioned earlier in the Front Panel section of this manual, the **Recto Pre** was from its inception, a recording pre-amp. Special emphasis was placed on achieving a direct sound and feel that would enable guitarists to record keeper tracks without the time and hassle normally associated with recording amplified guitar.

These two transformer balanced 1/4" TIP - RING - SLEEVE RECORD OUTPUTS jacks can be used in either balanced or unbalanced consoles. Both Outputs are fed a signal right after the junction where the EFFECTS LOOP'S RETURN'S join with the original signal so that any processing you have in the LOOP will appear at the RECORD OUTPUTS. The jacks are wired such that if you do not have a console with balanced inputs or you simply do not wish to use the balanced signal, you may connect a regular (shielded) mono 1/4" plug into the RECORD jacks and produce an unbalanced signal. While in most pro studios virtually all signals are balanced, this has no bearing on the quality of performance you can obtain on an unbalanced project or home studio environment. The main difference might be that of a slight roll off in the top end harmonics due to capacitance from longer cable lengths. This is best avoided by maintaining the shortest lengths of cable from the **Recto Pre** to the console. (This rule applies to all cabling in an unbalanced studio format.)

NOTE: These Outputs work in conjunction with the Front Panel Voicing mini toggle switch which, as discussed earlier, zeroes in on the sound style selected and tunes the voicing accordingly.

SETTING SIGNAL LEVELS: The levels present at the RECORD OUTPUTS are determined by the settings of both the individual Channel MASTERS' and the final OUTPUT Control. As discussed earlier under OUTPUT in the Front Panel section, settings between 9:30 and 12:30 seem to produce the best results for most all situations. For direct applications in many consoles we have found the 11:00 region to be a good starting point. This region, with similar settings on the individual channel MASTERS, seems to produce a very well behaved SIGNAL LEVEL for most applications. Set the console accordingly and you should have lots of room to adjust for different sounds in both channels.

NOTE: Avoid OUTPUT level settings above 1:00 when using the RECORD OUTPUTS as it is possible to overload the RECORD circuitry - as well as the input stage of many consoles - with certain settings of the channels and certain pickups.

REAR PANEL CONTROLS: *(Continued)*

LIVE OUT: To Power Amp The **Recto Pre** provides two output channels for feeding signal to either stereo power amplifiers, effects processors (see EFFECTS LOOP - presented earlier in the Rear Panel section of this manual) or even the effects return or power-in stages of self contained amplifiers. Thus the **Recto Pre** is a stereo capable pre-amp with two identical signals that appear at the MAIN OUTPUTS. For mono applications simply connect either of the MAIN OUTPUT jacks to your power amp or processor. To use both MAIN and RECORD OUTPUTS in a mono scheme simultaneously, connect opposing outputs (one channels' MAIN OUTPUT to your power amp - the other channels' RECORD to your console.

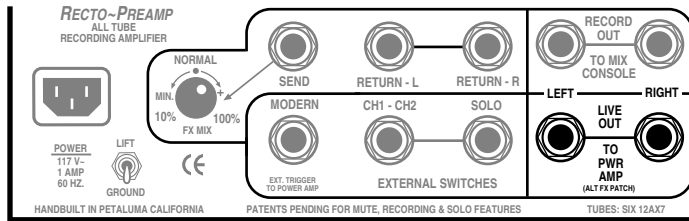

The MAIN OUTPUTS are fed signal from both individual channel MASTERS as well as the final OUTPUT Level Control located at the far right on the Front Panel. As mentioned earlier, the channels are controlled simultaneously with the single OUTPUT control, as this potentiometer is actually two synchronous pots in one. To control the output channels separately, they must be sent to two different power sources and then controlled independently from there. In this type of set-up it may be necessary to lift the ground on one of the power sources to prevent a ground loop. This application is most often seen when a pre-amp is used to feed two or more power amps on a large stage where there is need for both back line and stagefront monitor cabinets.

TUBE BAY: The **Recto Pre** uses six 12AX7A type dual triode pre-amp tubes for its' all-tube circuitry which are mounted horizontally and recessed in an easily accessible tube bay. In the unlikely event that you need to replace a tube, you may do so by simply unplugging it from its socket and plugging a new one in. Since the tube sockets grab the pins on the tube rather firmly, it helps to gently rock the tube back and forth while pulling outward on the tube (see illustration below).

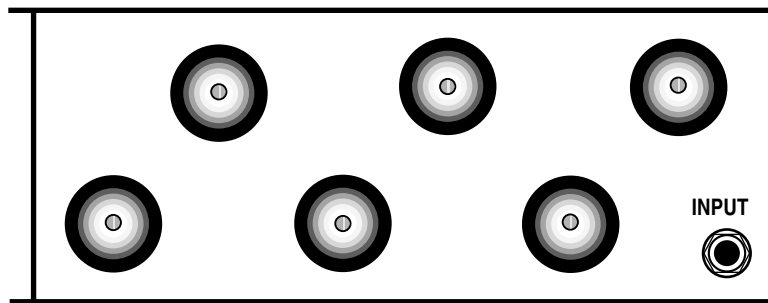

its socket and plugging a new one in. Since the tube sockets grab the pins on the tube rather firmly, it helps to gently rock the tube back and forth while pulling outward on the tube (see illustration below).

When installing the replacement, make sure that the pins on the tube are not bent (you can straighten bent pins with a pair of needle nose pliers) and line them up carefully before inserting the tube.

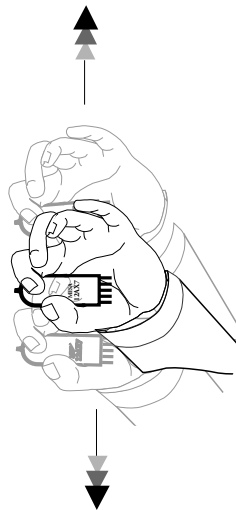

GENTLY ROCK TUBE BACK AND FORTH WHILE PULLING IN AN OUTWARD DIRECTION CAREFULLY

FACTORY SAMPLE SETTINGS:

CHANNEL 1 SETTING #1 Skinny Skank

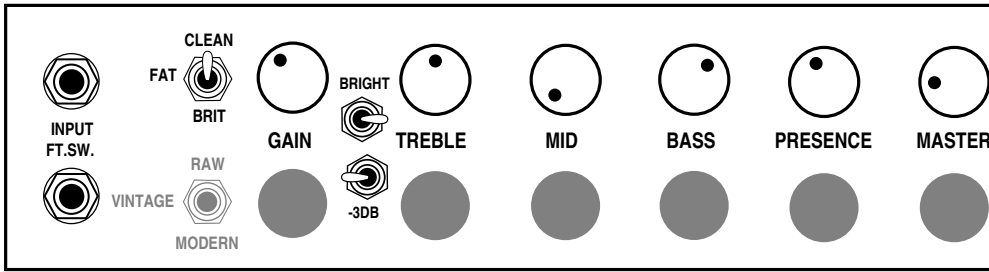

CHANNEL 1 SETTING #2 Rhythm Mix

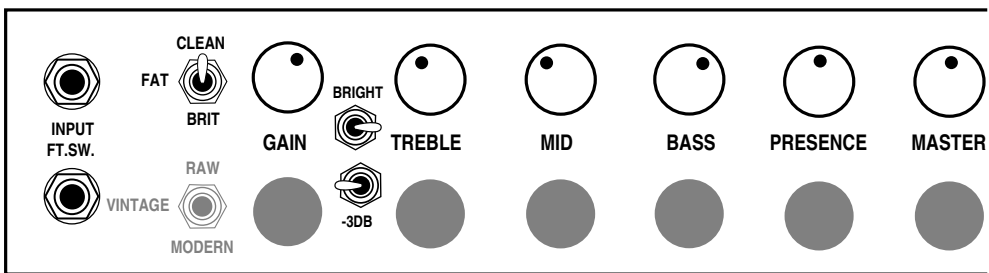

CHANNEL 1 SETTING #3 Power Rhythm

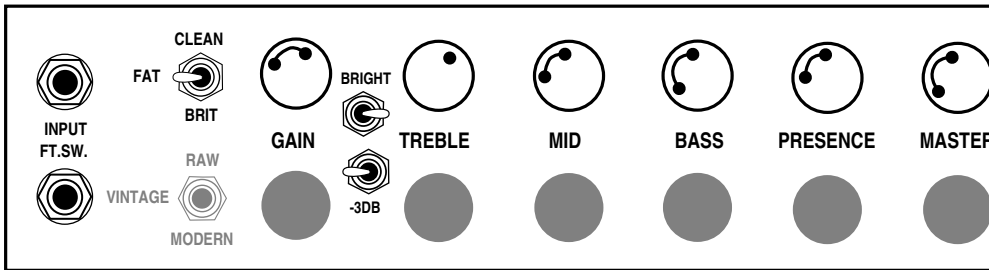

CHANNEL 1 SETTING #4 Brit Push

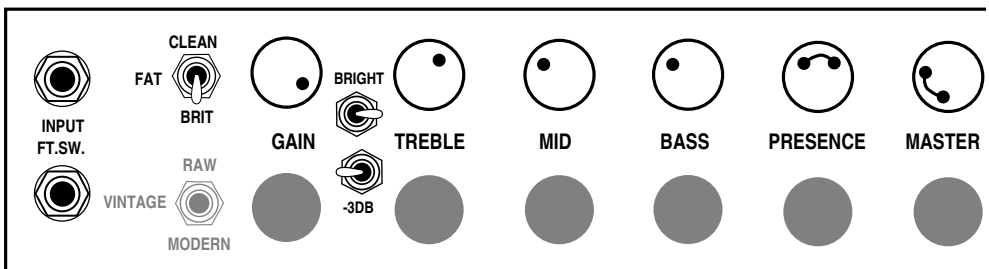

FACTORY SAMPLE SETTINGS:

CHANNEL 2 SETTING #5 Purring Blues

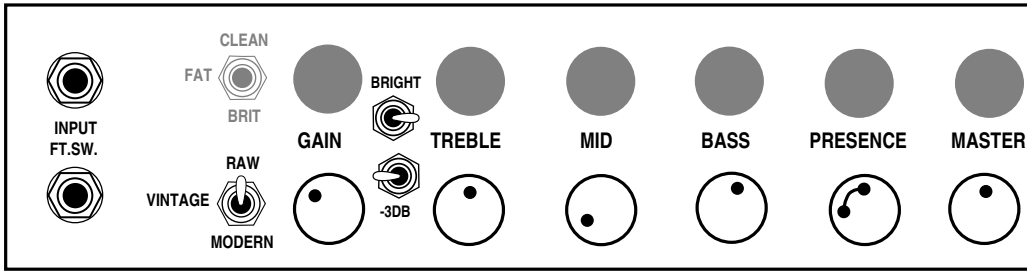

CHANNEL 2 SETTING #6 Smooth Grind

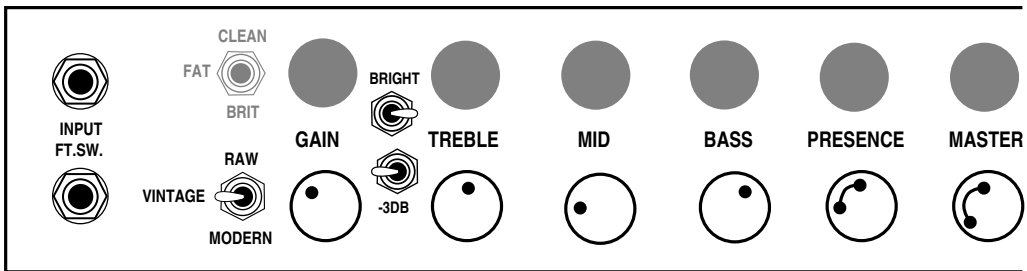

CHANNEL 2 SETTING #7 Liquid Solo (Recto Vintage)

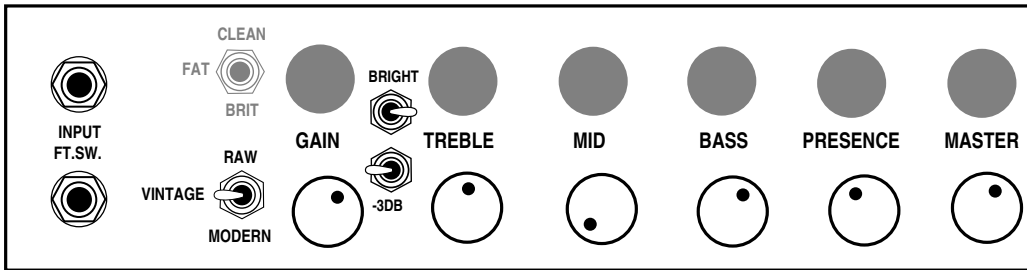

CHANNEL 2 SETTING #8 Modern Fury

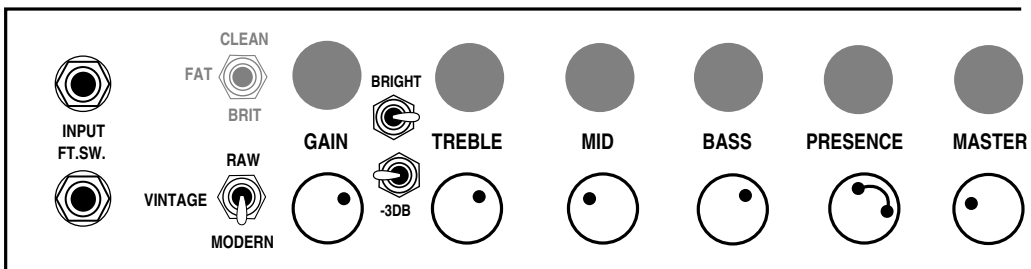

TUBE NOISE & MICROPHONICS:

You may occasionally experience some form of tube noise or microphonics. Certainly no cause for alarm, this quirky behavior comes with the territory and the Tone. Much like changing a light bulb, you don't need a technician to cure these types of minor user serviceable annoyances and in fact, you'll be amazed at how easy it is to cure tube problems...by simply swapping out a pre-amp or power tube!

First may we suggest that you set the amplifier up on something so that you can get to the tubes comfortably without having to bend down. It also helps to have adequate lighting as you will need to see the tube sockets clearly to swap tubes. Use caution and common sense when touching the tubes after the amplifier has been on as they may be extremely hot! If they are hot and you don't want to wait for them to cool off, try grasping them with a rag and also note that the glass down around the bulbous silvery tip is considerably less hot which makes it easier to handle. Gently rock the tube back and forth as you pull it away from its socket.

DIAGNOSING POWER TUBE FAILURE:

There are two main types of tube faults: shorts and noise. Both large and small tubes may fall prey to either of these problems but diagnosis and remedy is usually simple.

If a fuse blows, the problem is most likely a shorted power tube and shorts can either be mild or severe. In a mildly shorted tube the electron flow has overcome the control grid and excess current flows to the plate. You will usually hear the amp become distorted and begin to hum slightly. If this occurs, quickly look at the power tubes as you switch the amp to STANDBY and try to identify one as glowing red hot. It is likely that two of a pair will be glowing since the "shorted" tube will pull down the bias for its adjacent mates, but one tube may be glowing hotter — and that one is the culprit. The other two are often fine — unless they've been glowing bright red for several minutes.

Because there is no physical short inside the tube (just electrons rioting out of control) merely switching to STANDBY for a few moments then back to ON will usually cure the problem...at least temporarily. Watch the tubes carefully now. Should the problem recur, the intermittent tube will visibly start to over heat before the others and thus it can be identified. It should be replaced with one from the same color batch, shown on its label. Call us and we will send one out to you.

The severe short is not nearly so benign. In the worst cases, a major arcing short occurs between the plate and the cathode with visible lightning inside the glass and a major noise through the speaker. If this is seen to happen, IMMEDIATELY turn the amp to STANDBY. By this time the fuse probably will have blown. Such a short is usually caused by a physical breakdown inside the tube including contaminate coming loose or physical contact (or near contact) between the elements. Replace it and the fuse with the proper slo-blo type and power up the amp using the power up procedure as we described earlier in this manual.

TUBE NOISE:

Often caused by contamination within in a tube, the culprit can usually be identified, and by lightly tapping on the glass, you will probably hear the noise change. Hearing some noise through the speakers while tapping on the 12AX7's is normal however. And the one nearer the INPUT will always sound louder because its output is being further amplified by the second 12AX7.

The power tubes should be all but quiet when they are tapped. If crackling or hissing changes with the tapping, you have probably found the problem. To confirm a noisy power tube, merely put the **Rectifier Recording Pre** on Standby, remove it from its socket and turn it back on. It will cause no damage to run the unit briefly with one power tube missing. You may notice a slight background hum, however, as the push-pull becomes unbalanced. Whenever you are trying to diagnose a suspect tube, keep your other hand on the POWER and STANDBY switches ready to shut them off instantly in the unlikely case you provoke a major short.

If you think you've located a problem tube but aren't sure, we recommend substituting the suspect with a new one just to be sure of your diagnoses. You will be doing yourself and us a big favor by just following the simple guidelines previously mentioned regarding tube replacement. You'll probably be successful with much less effort than is required to disconnect everything and haul the unit to a technician who will basically perform the same simple tests. If the tubes are still within their six-month warranty period, we will happily send you a replacement. Just note the color designation on the tube label so that we can send you the appropriate match.

DIAGNOSING PRE AMP TUBE PROBLEMS:

Because your amplifier is an all tube design, it is quite possible that you will at some point experience minor pre-amp tube noise. Rest assured - this is no cause for alarm and you can take care of the problem yourself in a matter of minutes by simply swapping tubes.

Let us begin by saying; It is a "very good" idea to keep at least a couple of spare pre-amp tubes on hand at all times to insure uninterrupted performance. These minor pre-amp tube problems can take many forms but can generally be described in two categories: Noise and Microphonics. Noise can be in the form of crackling, sputtering, white noise/hiss and/or hum. Microphonic problems usually appear in the form of a ringing or high pitched squealing that gets worse as the gain or volume is increased thus are more noticeable in the higher gain "HI" modes. Microphonic problems are easily identified because the problem is still present even with the instruments' volume off or unplugged altogether - unlike pick-up feedback which ceases as the instrument is turned down. Microphonic noise is caused by mechanical vibration and shock: think of banging a microphone around and you'll understand where the word came from.

The best way to approach a pre-amp tube problem is to see if it occurs only in one specific mode or channel. This should lead you to the tube needing replacement. Then all that remains is to swap the suspect tube for a known good performer. If you cannot narrow down the trouble to a specific mode or channel, the problem may be the small tube that drives the power tubes which is operational in all modes and channels. Though rare, a problem with the driver tube would show up in all aspects of performance - so if you can't narrow the problem down to being mode or channel specific, you may want to try replacing the driver tube. Driver problems generally show themselves in the form of crackling or hum in all modes of performance and/or weak overall output from the amplifier. Occasionally an anemic driver tube will cause the amplifier to sound flat and lifeless, but this is somewhat uncommon, as worn power tubes are a more likely suspect for this type of problem.

Sometimes making the diagnosis is more trouble than it's worth and it's faster and easier to merely replace the small pre-amp tubes ONE AT A TIME with a replacement known to be good. But MAKE SURE you keep returning the tubes to their original socket until you hit the one that cures the problem. You'll notice that tubes located nearer to the INPUT jack always sound noisier...but this is because they are at the start of the chain and their noise gets amplified over and over by the tubes that follow. The tube that goes into this "input socket" (usually labeled V1) needs to be the least noisy of the bunch. The tube that goes at the end of the preamp chain - just ahead of the power tubes - can be quite noisy without causing any problem at all. The tubes in your amp have already been located in the most appropriate sockets and this is why you should NEVER pull them all out at once and ALWAYS swap them one at a time. ALWAYS return a perfectly good tube to its original socket. Also it's a good idea to put the amp on STANDBY when swapping tubes to reduce the heat build up in the tubes themselves and to prevent explosive noises (which can still occur even if you are pulling the tubes away from their sockets gently) from coming through the speaker.

Remember, take your time, be patient and chances are real good that you can fix your amp yourself by finding and replacing the bad tube. It kills us to see someone who has shipped their amp back to us...and all it needed was a simple tube replacement! If you must send back your amp, remove the chassis from the cabinet by unscrewing the four mounting bolts on the bottom top. The chassis then slides back like a drawer and comes out from the back. Remove the big power tubes and mark them according to their location from left to right 1, 2 etc. They need to be wrapped separately with plenty of wadded up newspaper around them and put in a smaller box within the larger carton. Remove the Rectifier tubes and wrap them also. You can leave the preamp tubes in or remove them and wrap them separately being sure to label their location. (See Tube Task Chart.)

To wrap the chassis, use plenty of tightly wadded up newspaper so there is at least six inches of "crush space" between the chassis and the cardboard box. Bubble wrap also works well, but please DON'T use styrene peanuts - they will shift during transit and get lodged inside your electronics as well as allowing your amp to end up at the bottom of the box unprotected and possibly damaged.

Pre-amp tubes don't normally wear out as a rule. Therefore, it is not a good idea to change them just for the sake of changing them. If there isn't a problem - don't fix it. If there is no result from your substitutions, it may be possible that you have more than one problematic tube. Though rare, this does happen and though it makes the troubleshooting process a little more intimidating, it is still possible to cure the problem yourself.

NOTE: It is normal to hear a slight metallic ringing sound when tapping on the preamp tubes. As long as the tube does not break into oscillation or start crackling or any other form of bizarre noise, it is considered normal and functional.

BIAS ADJUSTMENT: (part of a continuous series)

An Article written by Randall Smith that we thought you might find interesting.

Here's a question we often hear:

"Why doesn't **Mesa** put bias adjustments in their amplifiers?"

Well, there's a short answer and a long answer to this question.

The short answer is that during my 12 years of repairing Fenders, one of the most frequent problems I saw was bias controls that were either set wrong or that had wandered out of adjustment due to vibration. As any honest tech will tell you, there's lot's of easy money to be made by sprinkling "holy water" on amplifiers ... uh, what I meant to say is "Your amp needed biasing." See what I mean? What customer is going to argue with that?

It only takes a moment and a volt meter: The Fender diagram shows how: "Adjust this trim pot for - 52 volts." That's it. Nothing more.

Now don't be fooled into thinking that tubes "draw" more or less bias, they don't. The way a bias supply is connected to a tube is akin to a dead end road, it just trails off to nowhere without really completing a circuit. It's a static voltage and regardless of what tube is in the socket — or even if the tubes aren't plugged in at all, it doesn't change the bias voltage a bit.

So the end of the short answer is this: Since a bias supply needs to put out the right voltage and never vary, I wanted to build amplifiers that were individually hard wired to the correct values and NEVER needed adjustment. And for 25 years, that's how **Mesa/Boogies** have been built.

Time to change tubes? Just plug our tubes into any one of our amps and you're DONE. No tech needed. NO bills and no BS about biasing. And most important: The bias is RIGHT because it can't change!

Now, you want the long answer? Here's more information on how our hard-wired bias avoids trouble. Please read on.

But first, let's make an important distinction. Our business is designing and building high performance amplifiers. And for this we need tubes whose variance is within a narrow range. Our warehouse is full of rejects ...oh, they work — they just don't perform within our tolerance range. We have a very sophisticated computer - based tube testing system (nicknamed "Robotube") that matches and measures tubes over seven important parameters. It can even predict which tubes are likely to have a shortened lifetime — even though they work perfectly during the test.

Because our business is building quality amps, we can afford to reject a lot of wayward tubes. The guys you hear complaining because **Boogies** don't have bias adjusters are primarily in the business of selling tubes - not amps. They don't want to throw away 30 percent of their inventory, so they promote the idea that tubes outside our parameters can be used to "customize" amplifiers and they criticize us because our amps can't be adjusted to accommodate their out-of-**Mesa** tolerance tubes.

Now you might be thinking, "But I thought you just said that tubes don't "draw" bias, therefore they don't effect the bias supply and thus it doesn't need to be adjustable."

When you set the bias (whether it's by selecting the right resistors, as we do, or adjusting a trimmer — which is quicker) what you are doing is establishing the correct amount of idle CURRENT that flows through the power tubes. But you can't adjust the current directly, you can only change it by adjusting the amount of bias VOLTAGE that goes onto the tubes' control grids.

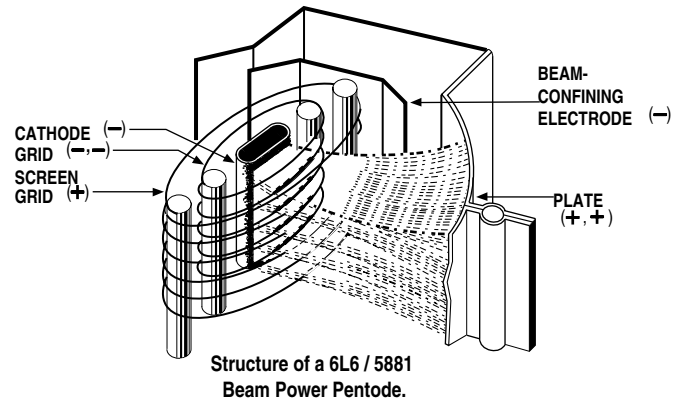

BIAS ADJUSTMENT: (Continued) Voltage and current are NOT the same. Current is the AMOUNT of electricity, the “quantity” — and is measured in amperes. Voltage is the degree of electric charge — like the “pressure” to use the old water analogy. Let me illustrate how different voltage and current are:

When you scrape your feet across a carpeted floor in dry, wintery conditions, your body can become charged with 50,000 to 100,000 volts of static electricity. And when you reach for the door knob, a spark jumps and you feel it! The voltage is super high but the current (measured in micro-amps) is tiny - otherwise you would die from electrocution.

Contrast this with your car battery, which puts out a mere 12 volts. You can lay your hands right across the terminals and not feel a thing. Yet the amount of current available can run to several hundred amperes .. enough to turn over a cold engine and get it started.

So current and voltage are two totally separate electrical parameters — though when you multiply them together, you get POWER, which is measured in watts.

When you set the bias of an amplifier, you are adjusting the static VOLTAGE at the control grid of the tube in order to produce a desired amount of idle CURRENT flowing to the tube’s plate. A small change in grid voltage, produces a large change in the amount of current flowing — and that’s basically how a tube works. Say that again because it’s super important: A small change in voltage at the grid causes a large change in current flowing to the plate. See, that’s the essence of amplification: A small change causing a large change. And here it’s a small voltage change causing a large current change.

The bias conditions are what determines how much current flows through the big power tubes when you’re not playing. And what drives your speakers is fluctuations in that current flow when are ARE playing. If the amount of current increases and decreases 440 times per second, then you’ll hear an A note. If the fluctuations in current flow are large and still at 440 per second, you’ll hear an A that is LOUD!

But for purposes of biasing, it’s the amount of “plate current” flowing with no signal applied that’s important. Unfortunately current is hard to measure because the circuit must be interrupted — as in “cut the wire” — and the meter spliced “in series” with the broken circuit. But measuring VOLTAGE is easy. It is not necessary to interrupt the circuit because a voltage reading can be taken in PARALLEL with the circuit intact.

Thus, as a matter of convenience, most bias settings are given in volts at the grid ... even though current through the plate is the important factor. In fact plate current is so inconvenient (and dangerous) to measure that Fender doesn’t even state what the correct value should be. They only give the grid voltage that will produce that current. (That’s the minus 52.) But that only happens if the tubes being used are “in spec.”

As long as the tubes ARE “in spec”, the right bias voltage will always give the correct plate “CURRENT” — but then there’s no need for the bias voltage to be adjustable!

If the tubes are NOT in spec, then the only proper way to re-set the bias is to cut the circuit and measure the current while adjusting the bias ... but no manufacturer I know even STATES the desired current value! Be that as it may, when the original bias voltage is altered far enough, it will compensate for the tube’s abnormal performance and the correct amount of idle current flow may then be restored. Clearly this is something most repair techs should not attempt.

Some newer amps have LED indicators connected to the circuit which will turn on when the right threshold of current flow has been reached. This is an improvement, and almost worthy if you’re willing to except resistors and lights added into your amplifier’s audio path — which we aren’t.

The other “advantage” of this system is that it allows some amp manufacturers to avoid matching their power tubes. The thinking is that adjusting the bias to each tube separately eradicates the inherent differences between the tubes by insuring that the same current flows through each one.

BIAS ADJUSTMENT: (Continued) Again, this has some merit .. but it's still not as good as using tubes that are matched in the first place because compensating for the mis-match causes the push-pull circuit itself to become unbalanced. Two wrongs don't really make a right.

Some of the other recommended biasing, "methods" — such as -" .. tubes running red hot, increase the bias .. sounds harsh and runs too cool, turn it down ..." are guesswork at best. Luckily, one of the great things about tube amps is that they can usually stand some abuse without causing any real harm ... at least not immediately. But don't these alterations imply that you are second-guessing the amp designer and that there's a better set of operating conditions that the designer missed but the tube sellers have discovered?

Now some players may like the sound of their amp altered by tubes with extreme characteristics and with the bias set to help compensate. But often it is the mere novelty of change that they're really responding to and when the amp goes back to the proper original way, we've seen them be far happier still!

Because every part in every one of our designs has been meticulously evaluated, compared and stressed over — no matter how seemingly insignificant it might be. And with every design we look for a "sweet spot" where all the parameters — including the bias — come together to give the best sonic performance, consistently and reliably. Every part and voltage is important — yet no one complains that these other parameters aren't available for tinkering.

Consider our patented **Simul-Class** circuitry where there are two different bias voltages used for separate pairs of power tubes ... and changing one voltage also changes the other. Great care goes into getting this just right and we think we'd be asking for trouble to have it adjustable for the world to play with ... unless you like paying to have your amp messed up. Sorry, I meant to say, "Uh, ... your amp needed biasing."

If that doesn't appeal to you, then merely plug a matched set of **Mesa** tubes into one of our amps and you're ready for tone. Guaranteed. You'd be amazed at the number of service calls we field every day that lead to a diagnosis of out-of-tolerance, non-spec tube problems. To think these would be prevented by including a bias adjustment is something of an insult to you and us. If you put the wrong size tires on your car, do you think changing the pressure will make them right?

Please, don't think this is a blanket indictment of the other guys selling tubes — it isn't. And their tubes aren't all bad either. It just doesn't make sense to pay more of your hard earned cash for tubes that were probably made in the same Russian or Chinese factory and which have the possibility of being outside the performance window we select for your amp. And it pains us to hear the hype and mystique built up around biasing when twenty-five years of evidence affirms our decision to make bias circuits that "never need adjustment". How much money and trouble that has saved **Mesa/Boogie** players you couldn't estimate.

Our rigorously tested and hand selected tubes are available at your nearest **Mesa/Boogie** Pro Center or from us directly. Nobody offers better price, quality or warranty than we do ... so why swerve?

Next time we'll talk about our part in developing the great Sylvania STR 415 type 6 6 and how we're on the verge of seeing something fairly close reappear on the market. Remember, we still have some of these super rugged mondo-bottles available for older amps — **Boogies** only please! Until then, Relax, Breathe and Nourish your soul!

Cheers!

Mesa/Boogie Ltd.

SPEAKER IMPEDANCE MATCHING & HOOK-UP GUIDE:

IMPEDANCE:

Wiring up speakers to provide the most effective load and making sure that all of them are in phase will help in creating the best sound possible. This is not too difficult, as long as you understand a few things about loading and how to connect your speakers to provide an optimal resistive load.

Mesa Boogie amplifiers can handle 4 and 8 ohms effectively. Never run below 4 ohms in a tube amplifier unless you are absolutely certain that the system can handle it properly; this can cause damage to the Output transformer. A few amplifiers can handle 2 ohms effectively without damaging them (for example the **Mesa's Bass 400+**). You can always have a higher resistance (16 ohms, for example) without damaging results, but too low of a resistance will likely cause problems.

MIS-MATCHING:

When running a higher resistance (for example: 8 ohm output into 16 ohm cabinet), a slightly different feel and response will be eminent. A slight mismatch can provide a darker smoother tone with a little less output and attack. This response is a result of the amplifier running a bit cooler. Sometimes when using more than one cabinet a mismatch will be the only option.

WHAT IS MY CABINETS IMPEDANCE:

If you have only a single speaker, you just match that single speakers impedance to the amplifier, and you are done. In many cases, you will have a number of speakers, and then you must calculate the "load" that the amplifier will need to support. There are generally three ways to wire multiple speakers together. They are as follows:

SERIES:

When you wire (hook-up) speakers in Series, the speakers resistance (as measured in ohms) is additive - i.e. putting two 8 ohm speakers in Series results in a 16 ohm load.

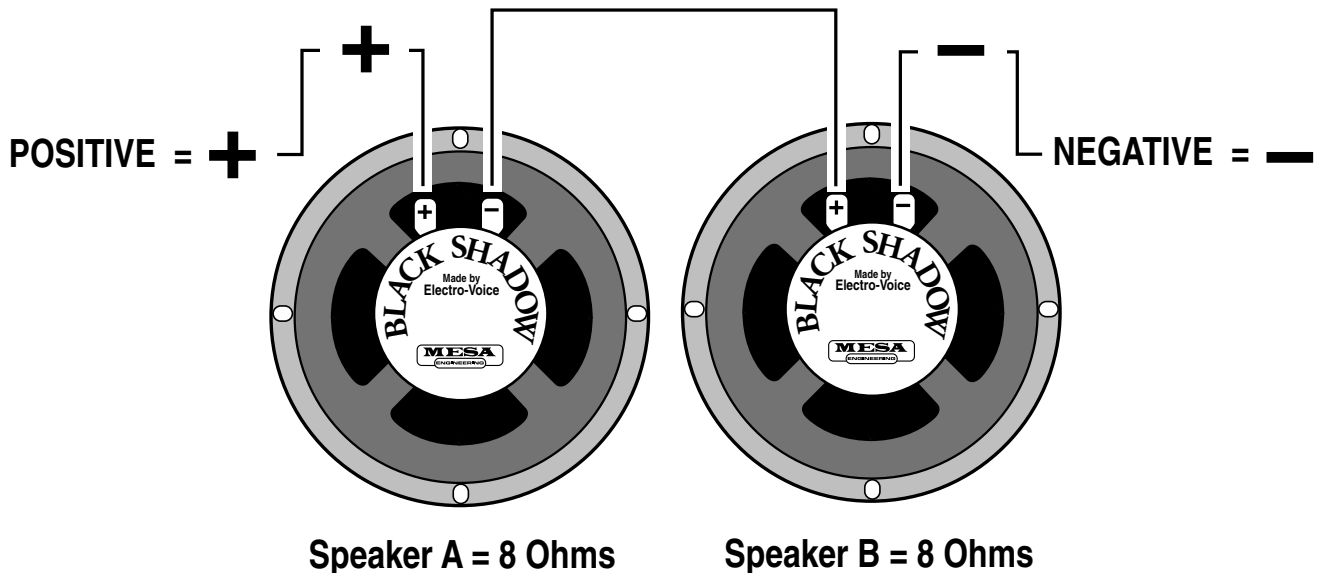

SERIES: Connect the Negative side of Speaker A to the Positive side of Speaker B

SPEAKER IMPEDANCE MATCHING & HOOK-UP GUIDE: (Continued)

PARALLEL:

When wiring in parallel, the resistance of the speakers decreases. Two 8 ohm speakers wired in (hooked-up) Parallel results in a 4 ohm load. It's easy to calculate the effect of a resistive load when all the speakers are all the same resistance. It is really not suggested to wire different resistive load values in Parallel (8 and 4, 16 and 8 etc.) The formula for figuring the total impedance in Parallel is the multiplication of the two loads divided by the sum of the two loads - i.e. putting two 8 ohm speakers in Parallel results in a 4 ohm load. Connect the Positive side of Speaker A to the Positive side of Speaker B - Connect the Negative side of Speaker A to the Negative side of Speaker B.

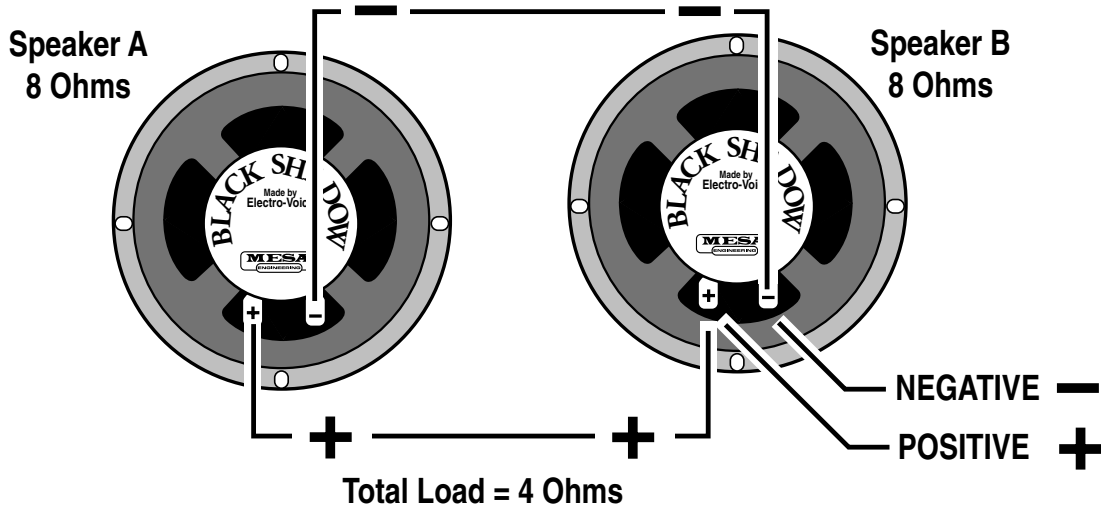

COMBINATION OF SERIES & PARALLEL:

This is really just two sets of Parallel wired speakers connected in series. This is how you maintain a consistent load with multiple speakers. The importance of this is more evident when you have more than one cabinet to connect to your amplifier. This is when you need to figure out the loads and how to wire them up without applying too low of a resistance on the amplifier.

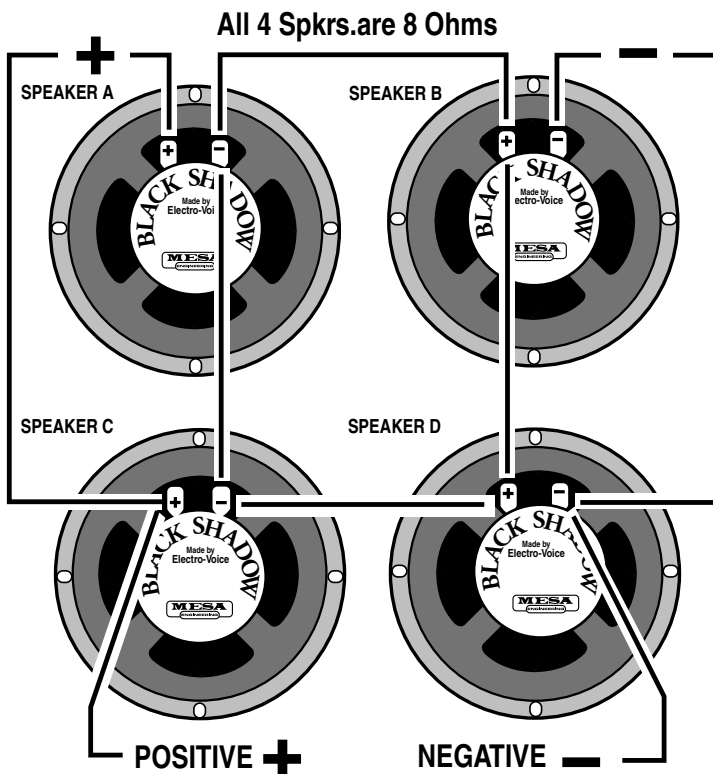

Simply connect the Positive side of Speaker A to the Positive side of Speaker C.

Connect the Negative side of Speaker A to the Positive side of Speaker B, then on to the Positive side of Speaker D and finally on to the Negative side of Speaker C.

And lastly, connect the Negative side of Speaker B to the Negative side of Speaker D.

4 Eight (8) Ohm speakers wired in Series Parallel = a Total Load of 8 Ohms.

WIRING SCHEMES...Amplifier to Speaker Cabinets

1

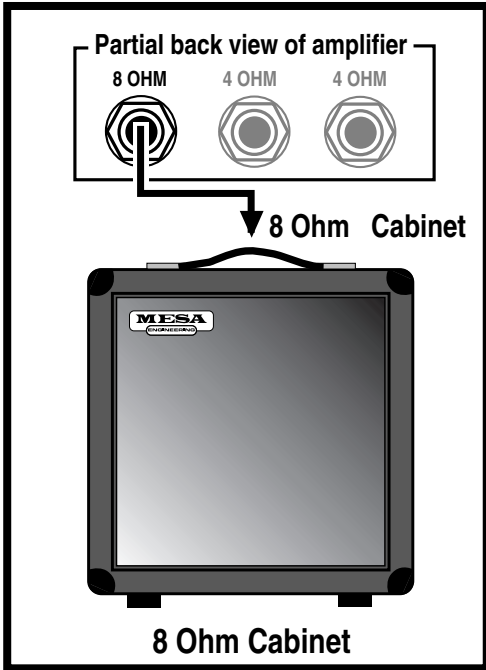

2

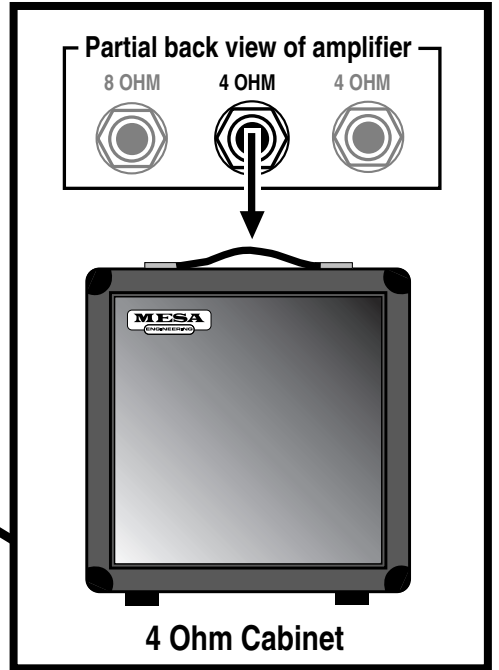

3

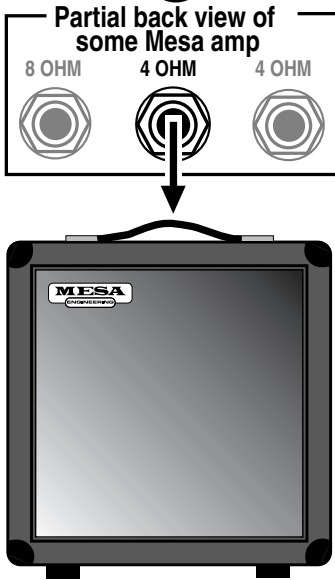

4

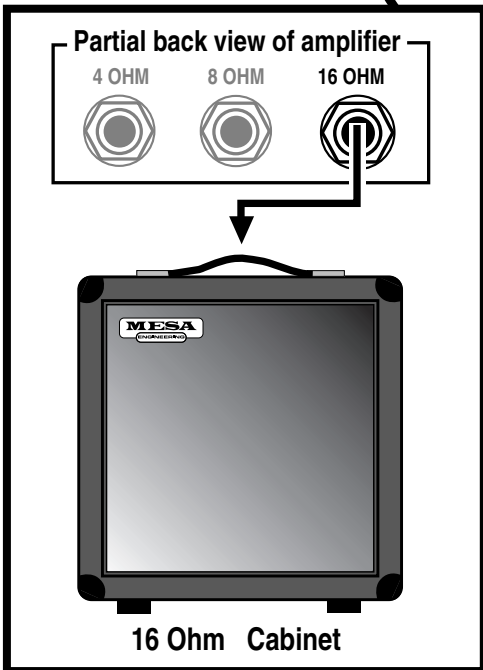

5

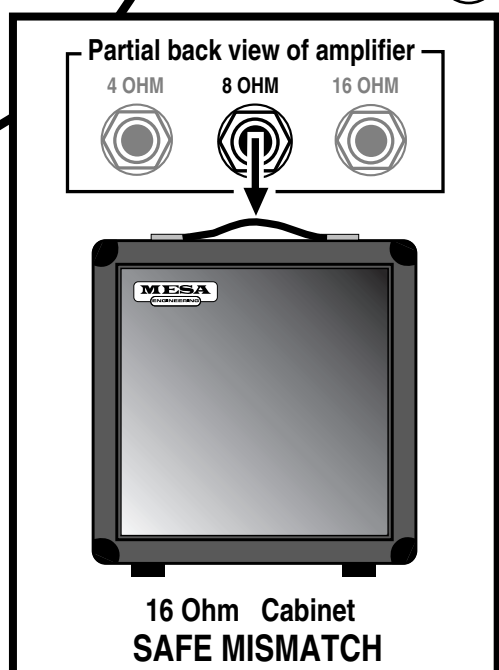

WIRING SCHEMES...Amplifier to Speaker Cabinets

6

7

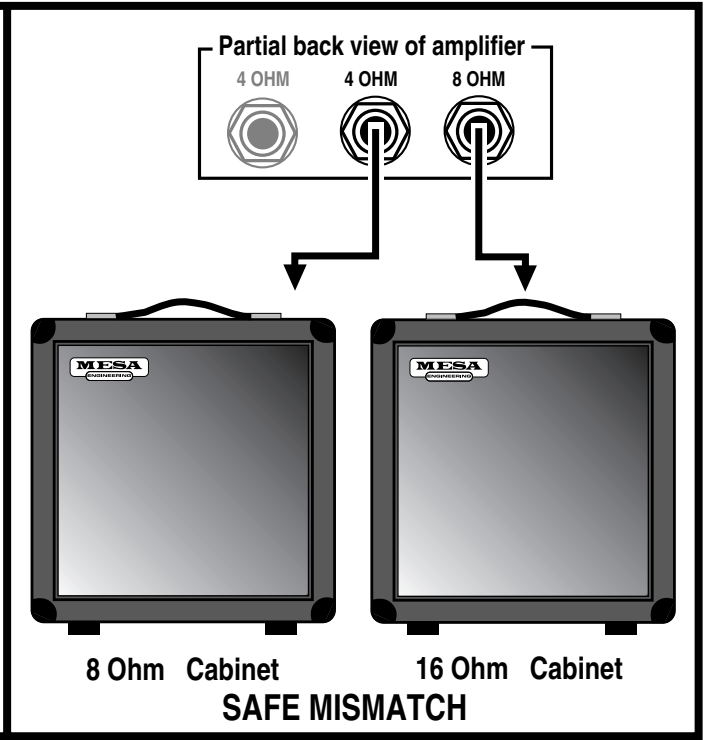
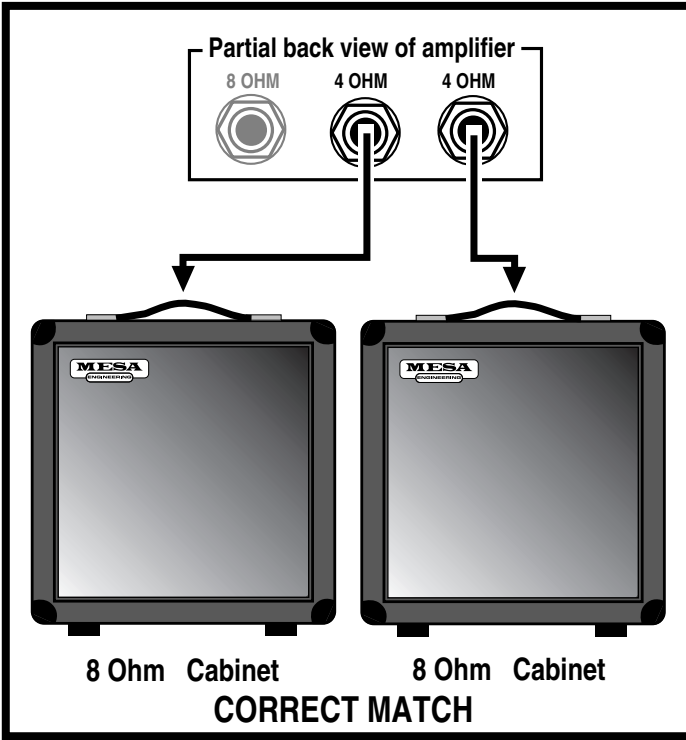

8

9

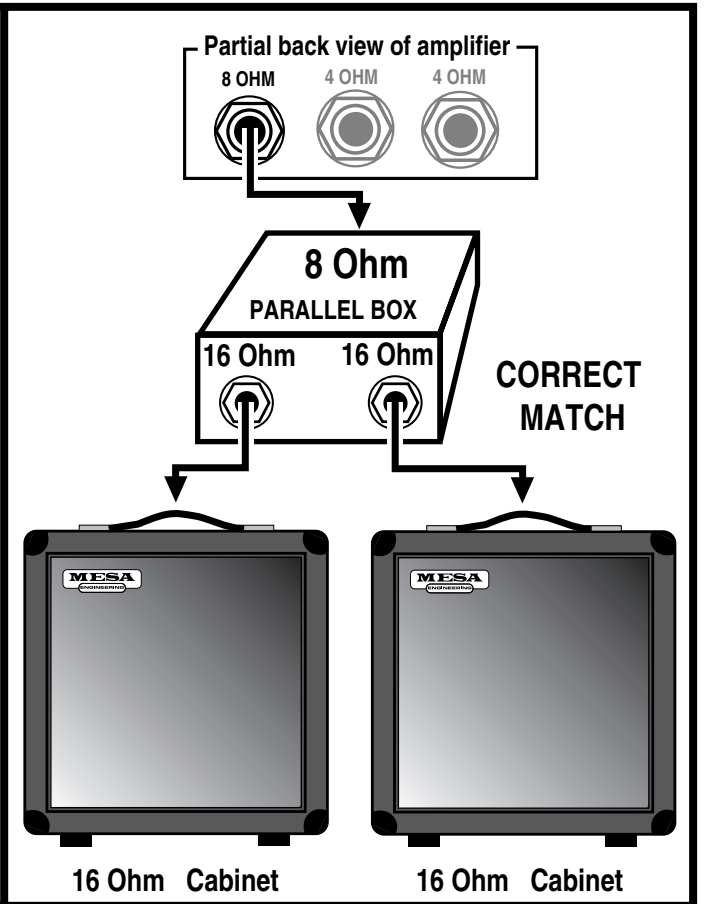
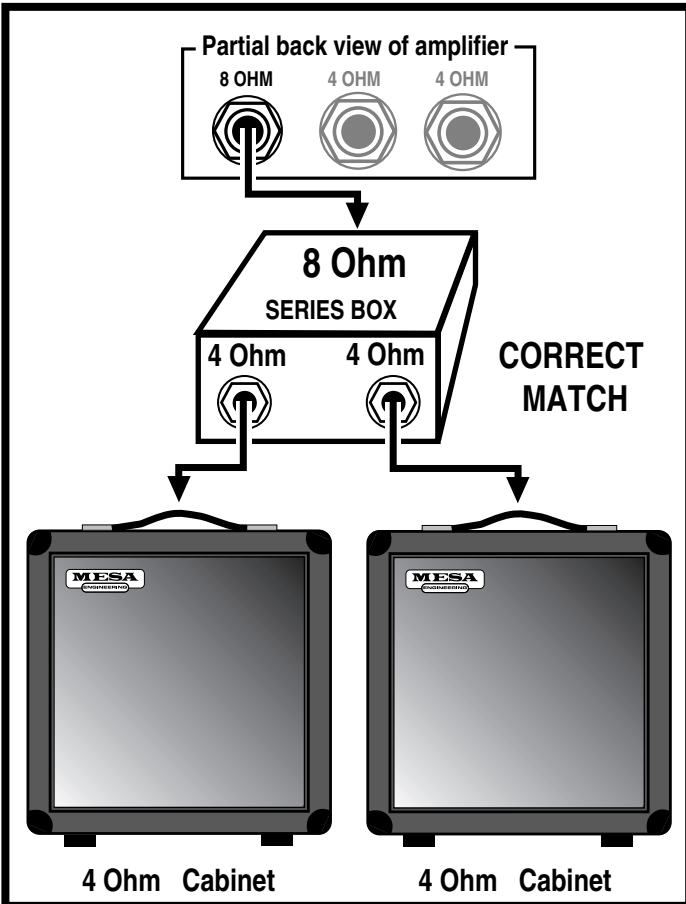

WIRING SCHEMES...Amplifier to Speaker Cabinets

10

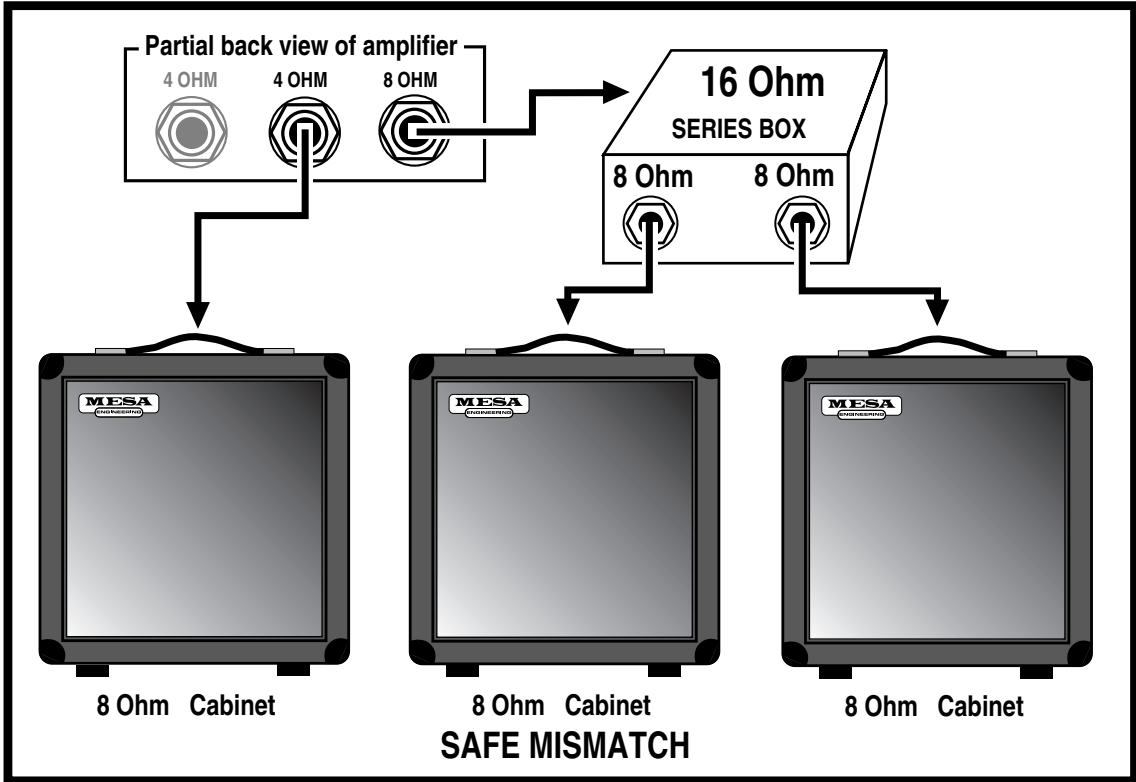

11

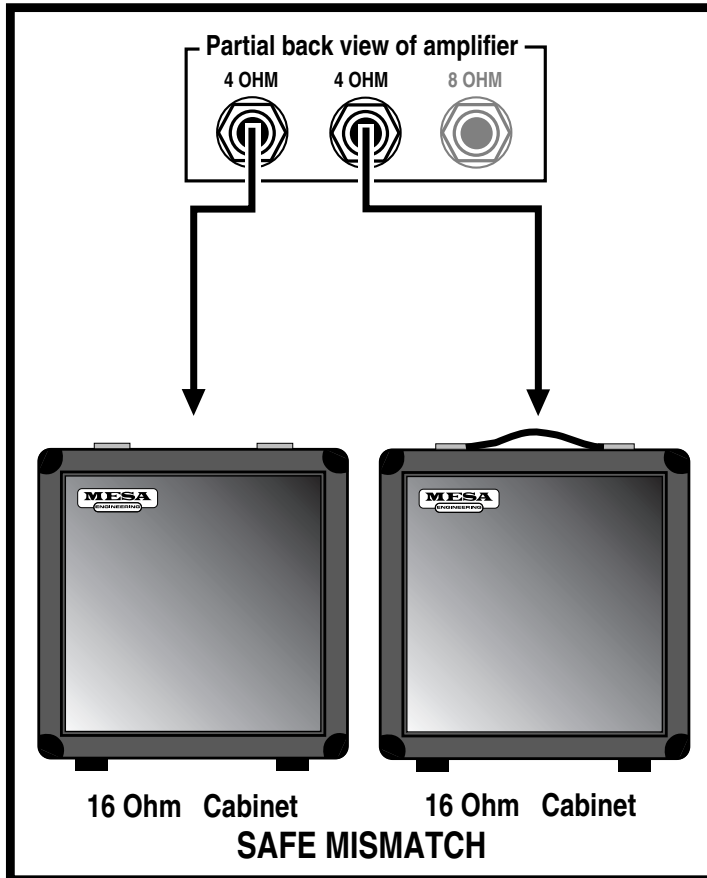

12

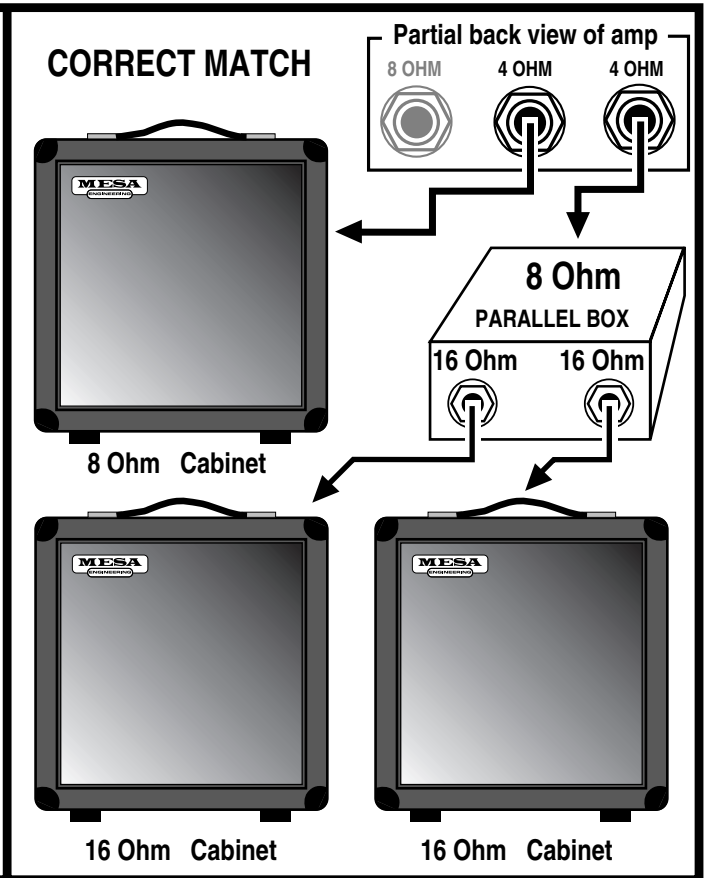

WIRING SCHEMES...Amplifier to Speaker Cabinets

13

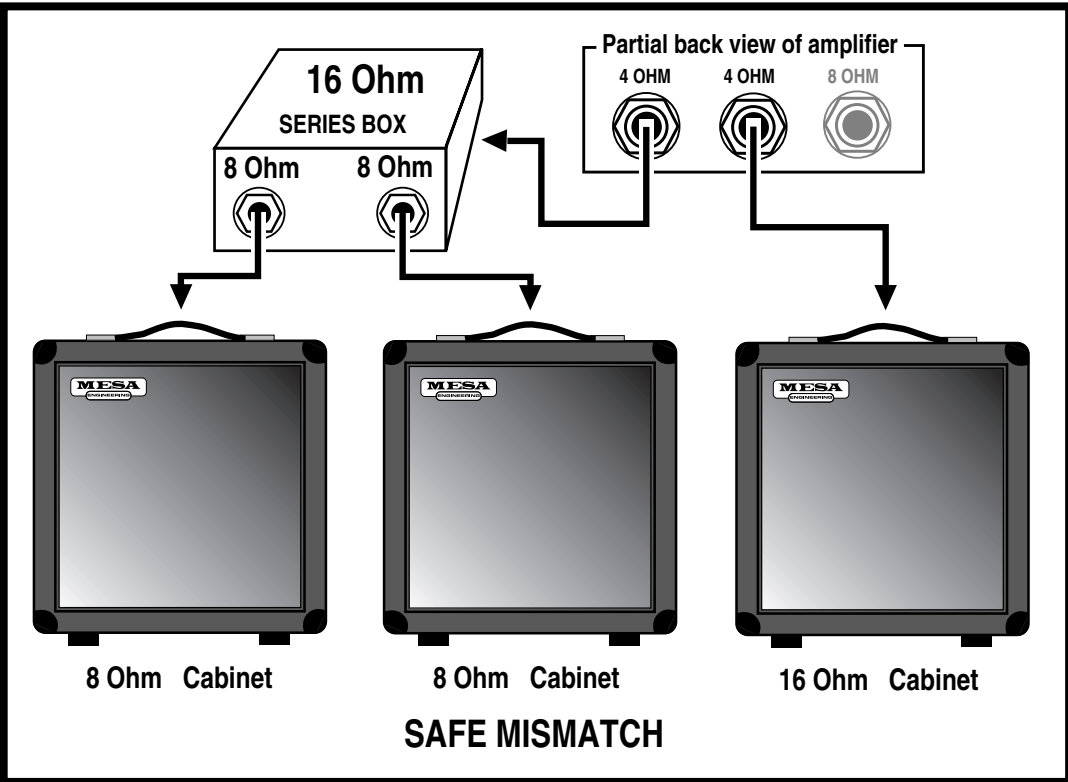

14

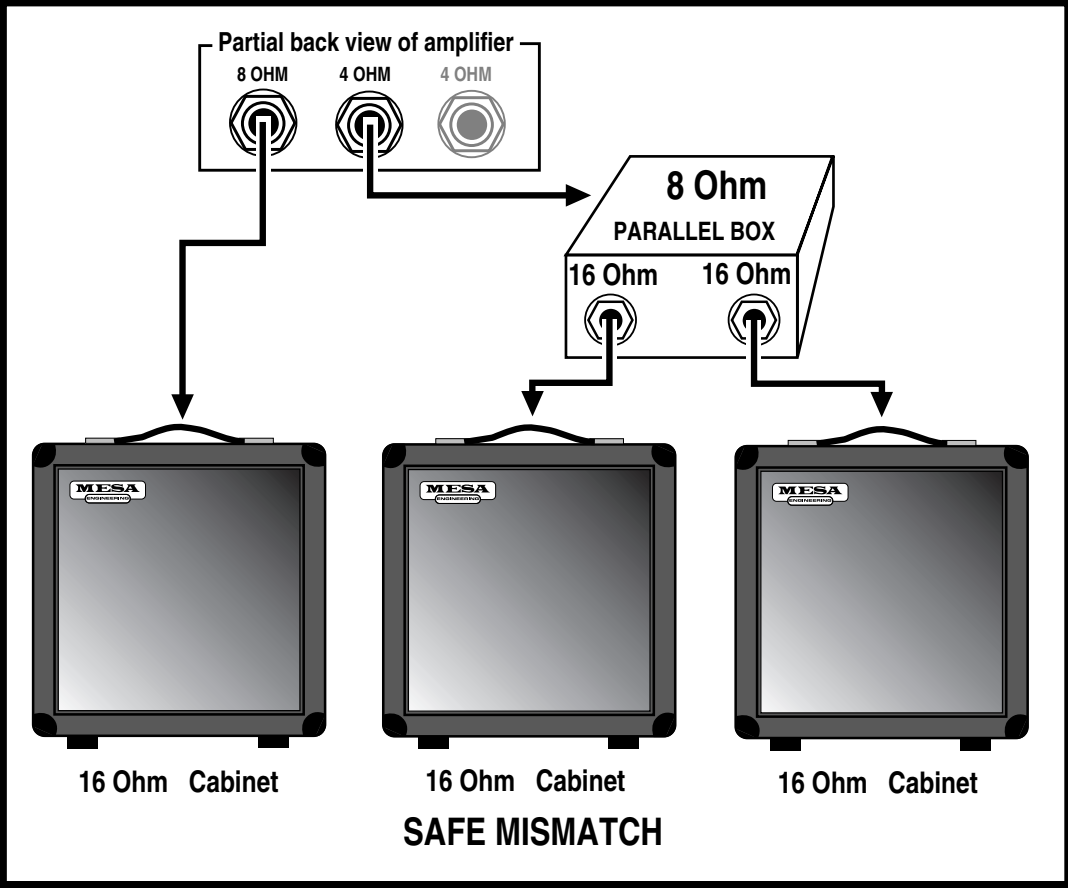

ON TRIODES, PENTODES & IRISHMEN:

With apologies to Friends and Relatives from the Emerald Isle - who will make their appearance soon enough - the humor which follows is dedicated to the memories of Spec McAuliff and Fae (Rafael) McNally, two of the True Greats.

As their numerical references suggest, the terms Diode, Triode and Pentode indicate the number of elements within the vacuum tube i.e. two, three or five. All tubes also require a filament or heater which is not included in the count. Its purpose is to excite electrons from the cathode coating by raising the temperature such that they are able to boil out of the electron-rich coating material and form a cloud of free electrons in the vacuum space surrounding the cathode.

Although the term filament and heater are often used interchangeably, there are specific differences: A filament is a directly heated cathode where cathode coating is applied directly to the heating element. Examples are 5U4 twin diode rectifier and 300B triode amplifier tubes. A heater, on the other hand, is a heating element which is separate from the cathode and is usually inserted within the tubular cathode sleeve. Examples are 12AX7 twin triode amplifier and 6V6 or EL84 beam power pentode tubes. In all cases this fundamental aspect of each tube's construction is clearly visible, especially when the heating element is glowing red hot.

The cathode, then, would be considered the first numbered element because it is the source of the electrons. The word itself is from the Greek literally meaning completely down, which implies a sense of central origin - like the center of the earth where Tone begins. It might be said that an ecstatic audiophile experiences a positive catharsis, his soul being purified when his system transports him to Audio Nirvana. The only trouble with taking this positive imagery too far is that the cathode is, unfortunately, negative... at least electrically speaking. However this is easily remembered since virtually all musicians and audiophiles have also experienced the more common negative catharsis when they emerge from the emotional rebirth kicking and screaming in rage and frustration.

Once heated, the intrinsically negative electrons are energetic little fellows of almost no mass. Thus they may be accelerated almost instantaneously and will travel through a vacuum a nearly the speed of light. Being of like, negative charge, they tend to repel one another and thus within the electron cloud surrounding the cathode, there is much jostling and elbowing as each one tries to maintain his distance from all the others... unless there is a strong and universal attraction from an outside influence.

Visualize, if you will, a group of sub-atomic Irishmen milling about and in a repellent, negative state of mind. All are scowling and none wants to have anything to do with the other. Now introduce a strong attraction say, a public bar, and you can easily picture an orderly, if rapid movement of the lot in a single direction. This is what happens when a positively charged element called the anode or plate is introduced into the vacuum.

The plate is the large metal element most prominently visible through the glass of an electron tube. It is the outermost element of a tube's structure and it surrounds all the others. The cathode is at the center radiating electrons outwards. As higher and higher positive voltage is applied to the plate, the attraction for the electrons surrounding the cathode is increased and with nothing standing in the way, full uninhibited flow to the plate occurs... sort of like removing the doors and offering free drinks to the crowd of surly Irishmen milling around outside. As electrons flow to the plate, the space charge will continually be replenished by further 'boiling' of the hot, electron-rich cathode as you can easily imagine other Irishmen impatiently taking up the places of those who've gone inside - until the entire village is deserted.

Now, where do they come from and how do they emerge? Well, a grand and elegant lady once showed me how to revive flat champagne: She dropped a raisin into the glass. There was a dramatic and immediate increase in effervescence with the introduction of a cathoding surface. Thousands of tiny bubbles suddenly appeared - and continued to flow from the raisin. Of course the bubbles were made up of gas dissolved in the beverage, but the analogy makes it easy to visualize the loosely bound electrons dissolved in the rich cathode coating as they effervesce from its heated surface.

But back to the electron flow. If the electrons are strongly attracted to a positively charged plate, then it follows that they are strongly repelled by a negatively charged plate and they are. Thus, if an alternating current - such as comes from a transformer - is applied to the plate, electrons will flow only during the times when the plate is positively charged. During periods of negative plate charge, electron flow is stopped and the space charge of electrons remains compressed in the area around the cathode.

ON TRIODES, PENTODES & IRISHMENT: (Continued) Thus a diode tube - one with a cathode and an anode - is mostly used to rectify alternating current into direct current by passing it without restriction, but in one direction only. This also explains why closing time is strictly enforced at Irish pubs: During normal operation, the traffic flow is similarly unimpeded and uni-directional toward the bar and this process rectifies the work-day negativity. It goes without saying that no one leaves as long as the atmosphere around the bar remains positively charged.

TRIODES:

This section is a continuing technical treatise on the workings of Irish Pubs but to make it easier for the layman to understand, it is explained in terms of vacuum tube technology. Enter the original bar - free beer and no doors. Well, it turns out that some control over the flow can be a necessary and useful advantage. This led to the invention of those swinging louvered saloon doors which are open at the top and bottom. They are patterned after the control grid of the vacuum tube, which is a loosely wound coil of thin wire located between the cathode and the plate.

In a Triode the plate is always positively charged with high voltage D.C. and even though the grid is blocking the path, those negative electrons can still FEEL the strong attraction - just as the Irishmen can see in through the louvers of the bar doors. They know what pleasures lie beyond, but to get there requires overcoming the negative influences controlling the access. This negative influence is typically called a Bias. In electronic terms that means the grid is supplied with a voltage which is slightly MORE NEGATIVE than the already negative electrons. The more negative the Bias, the more it tends to neutralize the attraction of the plate and repel the electrons back toward the cathode.

The Irish can be similarly charged with Bias, but unless you are Irish yourself, this type of Biasing may be more difficult to understand. The effect is similar though: The more negative the Bias, the more it impedes forward progress. Generally speaking though, the electronic Bias of the grid is easier to overcome, and for two main reasons: First, the Bias is set - like the bar doors - to allow some passage. Second, the grid is mostly NOT THERE, like the louvered doors which are mostly open spaces. Unlike the plate which is solid, the grid is like a coiled bed spring. It can create a repelling field but mostly it's empty space in between widely separated windings of wire. It's very easy to control the electrons as they pass through the grid's force field: Changing the grid voltage only slightly will have an enormous effect on how much current flows through... and that's what AMPLIFICATION is: a small change in voltage at the grid causing a large change in current flowing to the plate.

The purpose of the louvered bar doors is similar to that of the grid, namely, to give momentary pause while still revealing the promise within. Hesitation mostly gives way to temptation, but there are those few stalwart Irishmen who think twice and decide to come back later. Most just pause slightly then go on through. That is the purpose of the bar doors: to prevent everyone from crowding in all at once - and as the door is made less of a barrier, wider spaces between the louvers, more of the bar's attractive influence is felt outside thus amplifying the customer flow and increasing the crowd at the bar.

PENTODES:

Occasionally though, bar doors - even the louvered type - were found to be too effective, and too many customers turned away. Something further was needed to increase the attraction of the bar and overcome the resistance created by the door. Thus the cocktail waitress was invented.

Once again the idea was inspired by the vacuum tube. It had been discovered in some tubes, often large power types, that the distance to the plate was too great to attract enough electrons past the negative influence of the control grid. So another grid coil of fine wire was inserted between the first grid and the plate. This was called the screen grid and carrying a highly positive charge, it functioned as a "bait" for the plate.

In a properly designed power tube such as an EL84 or a 6V6, the windings of the screen grid are precisely aligned to fall in the shadow of the control grid. This way the electrons responding to the pull of the screen grid are lined up in sheets as they pass between windings of the inner control grid... only to find that they have been fooled! Once past the control grid and drawn toward the screen grid, they discover...there's almost nothing there. The path they're on has them aligned to zing straight through the spaces BETWEEN screen grid windings. So rather than a close and personal encounter, they just fly on past - and once they're out that far, there's no stopping them. The influence of the plate takes over and - being solid metal and of the highest positive attraction - it is at this final destination that the electrons congregate.

ON TRIODES, PENTODES & IRISHMEN: (Continued) Thus the proper cocktail waitress - visible through the louvers - is scantily clad so as to be all the more effective at reinforcing the attractive influence of her bar and by being located in between the door and the bar, she serves as bait to lure customers past the door's negative influence. Once through the door however, it is the rare Irishman who actually comes in personal contact with the cocktail waitress as, for all intents and purposes, she - like the screen grid - turns out to be a vanishing illusion. Yet, having come this far, the solid influence of the bar itself now takes over and attracts the customers to congregate, having happily reached their destination.

If you're still following this and haven't lost track of the count, you'll know we're still one element short of the five needed to make a Pentode. This last part is a pair of beam-confining shields which being negatively charged, serve to direct the flow right toward the plate. This is much the way a short entrance hall to the bar prevents wandering accidentally into the Men's room on the way.

Once at the bar though, the circuit is complete and the process of soul-nourishing works its ritual magic. Biases having been overcome, illusory nightingales having vanished, the spirits truly soar and the once surly Irishmen now are filled with warmth, wit and kindred friendship, enjoying the music and glowing nicely with their heaters on.

With appreciative thanks to the inhabitants of the Land of the Leprechaun, we have now concluded our little diversion into the mechanics of proper bar lay-out.

A feature article by Randall Smith
Designer / President

MESA/BOOGIE

The Spirit of Art in Technology

Thank you for trusting MESA/Boogie to be your amplifier company and we wish you many years of toneful enjoyment from this handbuilt all tube instrument.

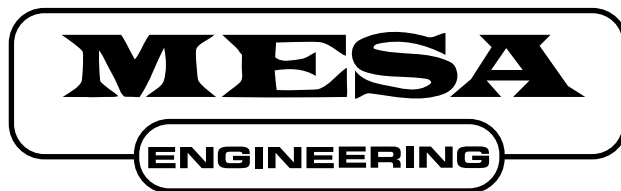

The Spirit of Art in Technology



(707) 778-6565 FAX NO. (707) 765-1503
1317 Ross Street Petaluma, CA 94954
USA