

MESA/BOOGIE

SUBWAYTM BLUES

The Spirit of Art in Technology

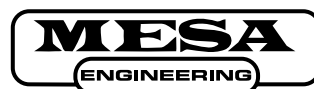

*1317 Ross Street Petaluma, CA 94954
USA*

Hello from the Tone Farm...

YOU, the smart player and all around intuitive human, have put your trust in us to be your amplifier company. This is something we do not take lightly. Our reward is that we've made a classic amplifier and by choosing this amplifier, you have become part of the Mesa family...Welcome! Our goal is to never let you down. Your reward is that you are now the owner of an amp bred of fine all tube amp heritage...benefiting from the many patented pioneering Mesa/Boogie circuits that led to the refinement of your new instrument. Feel confident, as we do, this amp will inspire many hours of musical satisfaction and lasting enjoyment. It was built with you in mind, by players who know the value of a fine musical instrument and the commitment it takes to make great music. The same commitment to quality, value and support we make to you...our new friend.

SUBWAY ROCKET™

Precautions _____	0
Overview _____	1
FRONT PANEL:	
Power-Up _____	2
Inputs _____	2
CONTROLS:	
Volume (Gain) _____	2
Treble _____	3
Midrange _____	3
Bass _____	3
Reverb _____	4
TOGGLE SWITCHES	
On / Standby _____	4
Power _____	4
REAR PANEL	
Ground _____	5
Fuse _____	5
Recording _____	5
FX Loop: Send & Return _____	6
FX Mix _____	6
Silent Recording _____	6
Speaker _____	6
Personal Settings Page _____	7
TUBE MAINTENANCE	
Tube Noise & Microphonics _____	8
Diagnosing Power Tube Failures _____	8
Tube Noise _____	8
Diagnosing Pre-Amp Tube Problems _____	9
Bias Adjustment _____	10,11 & 12
Part Sheet _____	13

Your MESA/Boogie Amplifier is a professional instrument. Please treat it with respect and operate it properly.

USE COMMON SENSE AND ALWAYS OBSERVE THESE PRECAUTIONS:

Do not expose amplifier to moisture, rain or water, direct sunlight or extremely high temperatures.

Always insure that amplifier is properly grounded.

Always unplug AC power cord before changing fuse or any tubes.

When replacing fuse, use only same type and rating.

Avoid direct contact with heated tubes.

Insure adequate air circulation behind amplifier.

Keep amplifier away from children.

Be sure to connect to an AC power supply that meets the power supply specifications listed on the rear of the unit.

If there is any danger of lightning occurring nearby, remove the power plug from the wall socket in advance.

To avoid damaging your speakers and other playback equipment, turn off the power of all related equipment before making the connections.

Do not use excessive force in handling control buttons, switches and controls.

Remove the power plug from the AC mains socket if the unit is to be stored for an extended period of time.

Do not use solvents such as benzene or paint thinner to clean the unit. Wipe off the exterior with soft cloth.

YOUR AMPLIFIER IS LOUD! EXPOSURE TO HIGH SOUND VOLUMES MAY CAUSE PERMANENT HEARING DAMAGE!

No user serviceable parts inside. Refer service to qualified personnel. Always unplug AC power before removing chassis.

EXPORT MODELS: Always insure that unit is wired for proper voltage. Make certain grounding conforms with local standards.

READ AND FOLLOW INSTRUCTIONS OF PROPER USAGE.

SUBWAY BLUES Operating Instructions

Precautions 0
Overview 1

FRONT PANEL:
Power-Up 2
Inputs 2

CONTROLS:
Volume (GAIN) 2
Treble 3
Midrange 3
Bass 3
Reverb 4

TOGGLE SWITCHES
On / Standby 4
Power 4

FRONT VIEW: *SUBWAY BLUES* REAR PANEL

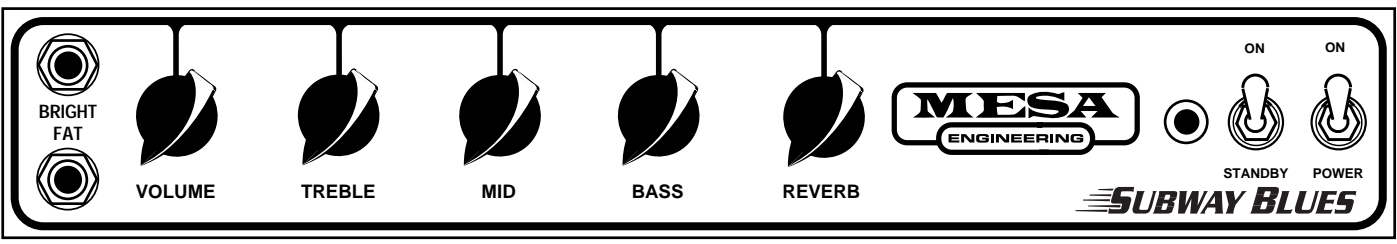

Ground 5
Fuse 5

REAR VIEW: *SUBWAY BLUES* Recording 5
FX Loop: Send & Return 6

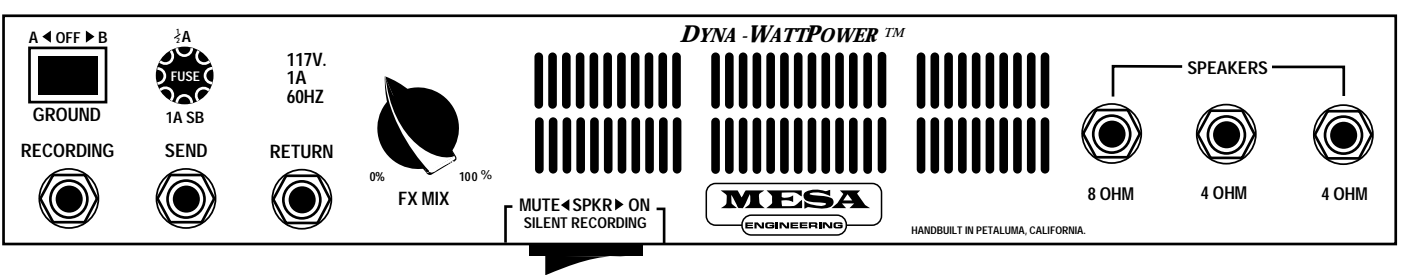

FX Mix 6 0
Precautions 6 1
Speakers 6 1
Overview 6
Silent Recording 6

FRONT PANEL:

INPUTS: First familiarize yourself with the layout of the front panel. Your SUBWAY amplifier is fitted with two INPUTS which are voiced individually for very different personalities and feel. BRIGHT would be the choice for all clean playing styles where sparkling highs are needed. This jack also lets the true sound of the instrument come through and would be the choice for traditional style solo work. FAT enhances the lower to medium midrange frequencies producing a bolder voice that sings with conviction. This jack helps saturate single notes while adding a percussive quality to the attack. It is very helpful when using guitars with lower output pick-ups i.e. old single coils.

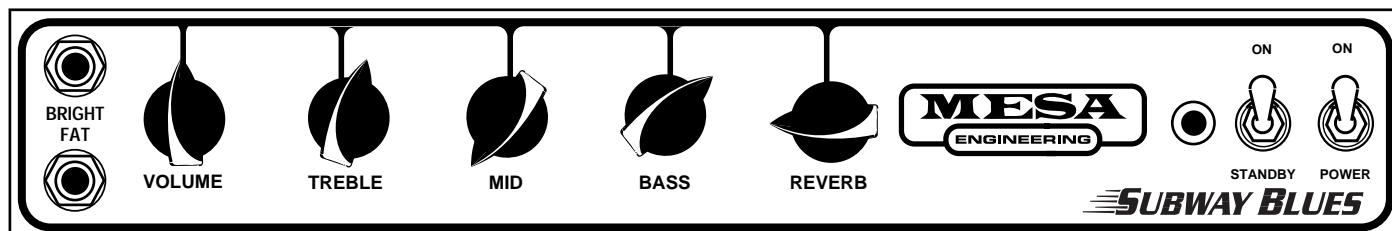

POWER-UP: Connect your favorite guitar to one of the two instrument input jacks. Flip the POWER switch “ON” while leaving the STANDBY switch set to “STANDBY”. It’s always a good idea to practice this start up procedure, as at least 30 seconds of warm-up time lessens the shock on cold power tubes, thus prolonging their life substantially. Next, set the controls per the example above:

NOTE: When disconnecting the instrument cable from the Inputs, it is normal to hear a metallic sound...This is not a microphonic tube as you may have heard when tapping the faceplate of an all tube amplifier. This noise occurs because the Inputs are wired in parallel and for a brief second they are floating as you unplug your instrument. Again, this is normal and no cause for concern. This noise goes away completely as soon as you connect your instrument.

CONTROLS:

VOLUME: (Gain): This is by far the most powerful control in the amp. It not only determines the amplifier’s overall Gain amount, shape and sensitivity...but it is also a powerful tone control. Generally speaking, whatever is dialed here ultimately determines the amp’s personality. Set low, it allows cleaner, brighter sounds with enhanced dynamic response, especially in the higher frequencies. Set high, the whole personality of the channel becomes darker, fatter and more overdriven.

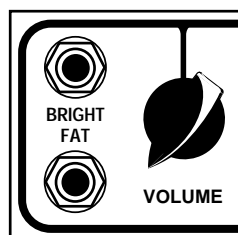

In the SUBWAY we worked hard to make sure the entire range of Gain available is usable and more importantly, musical. Don’t think for a moment that this simple one knob layout limits you as to the amount and texture of Gain. Long neurotic hours were spent to ensure the range of Gain was stylistically accurate.

This would be a good time to mention that most of the great sounds can be found by setting the SUBWAY’S VOLUME control moderately. Use of moderation here will reduce the likelihood of pesky tube microphonic problems.

Precautions	0
Overview	1

CONTROLS: (Continued)

TREBLE: As with most guitar amplifiers, the TREBLE control is the strongest of the three rotary tone controls. Its setting on the SUBWAY determines the blend and strength of the MIDDLE and BASS controls. Set high, it is the dominant control, minimizing the amount of MID and BASS that would be possible in the mix. Set low, the TREBLE becomes the recessive control and a warmer, darker blend is produced. Dial with care. Subtle tweaking of this control tends to produce the best results.

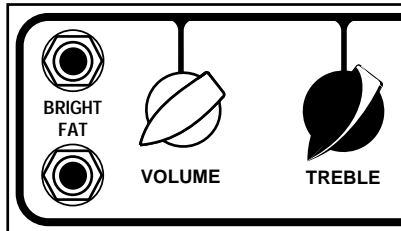

MIDRANGE: Through endless daily tone dreaming, the "if-only" design dictum led to the creation of this very useful tone control. From to about to the taper is adjusted to act as a very effective MID control. As you increase the MID to and above, you will hear the lower mids getting more pronounced and fatter. At about the MID leaves behind the old notion of being a tone control and becomes a truly usable Gain control. The upper range of the MID control is a smokin' addition to the SUBWAY'S VOLUME

control for all kinds of higher gain rhythm/lead sounds. Try the MID set high and the VOLUME - control at about for a cool blues solo sound. If this still isn't crazy enough for you...Max the VOLUME and TREBLE controls as well. This should be sufficiently grinding for all you crunch fiends. As you will hear, the versatility found in the MID control greatly enhances the overall sound of this amplifier. The described setting procedure for this control would be the same for either of the two input jacks.

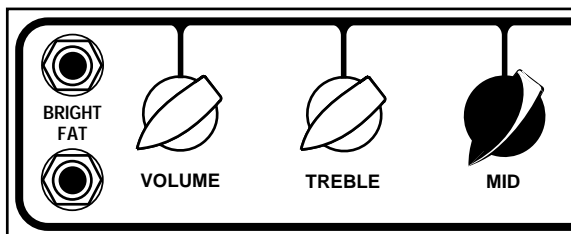

NOTE: The lower region of the MID control determines midrange punch and boldness in lower gain sounds and a smooth vocal blend in high gain sounds. It can be very effective acting as a "cut through the band control" in certain situations. Dial to taste, remembering that the setting of the TREBLE control greatly affects this control's strength.

BASS: This control blends in the lower frequencies, and its effectiveness, again, depends on the setting of the TREBLE control. It should be set with moderation, as extreme settings in either low or high directions can produce an unbalanced tone. Be especially careful when using the SUBWAY at high VOLUME level settings because too much BASS will cause a flabby, unfocused sound that can't be dialed out because excessive BASS has been introduced to the pre-amp in the early stages. Try setting the BASS to

while using the BRIGHT input jack, and when using the FAT input jack.

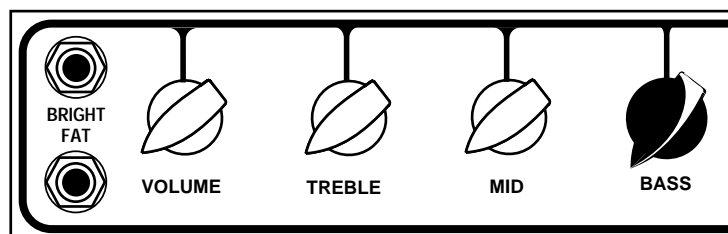

These settings will vary with the amount of VOLUME and TREBLE you have dialed up.

Precautions	0
Overview	1

CONTROLS: (Continued)

REVERB: The SUBWAY BLUES has an individual REVERB control. This enables different amounts of the rich ALL TUBE REVERB to be mixed with the dry signal.

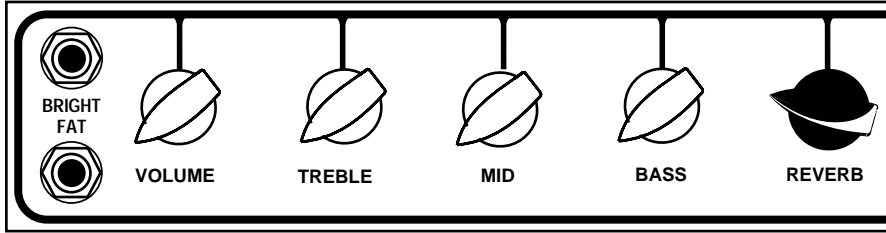

NOTE: It's normal for Maximum or even very high settings of the REVERB to alter the amplifier's voice slightly. This is a result of listening to the REVERB return stage high in the mix and no cause for alarm.

TOGGLE SWITCHES:

ON / STANDBY: Perfect for set breaks...this toggle switch also serves an even more important purpose. In the STANDBY position the tubes are at idle so that during power up they may warm up before being put to use. Before the POWER is switched on, make sure the STANDBY switch is in the STANDBY position. Wait at least 30 seconds and then flip the STANDBY switch to the "ON" position. This helps in preventing tube problems and increases their toneful life substantially.



POWER: This switch delivers the A.C. POWER to the SUBWAY BLUES. Make sure the unit is grounded (all three terminals of the A.C. POWER cord must be connected whenever possible to avoid injury to the user as well as to the unit) and that the proper voltage is present. Follow the cold start procedure described in the ON / STANDBY section above when powering up your amplifier.

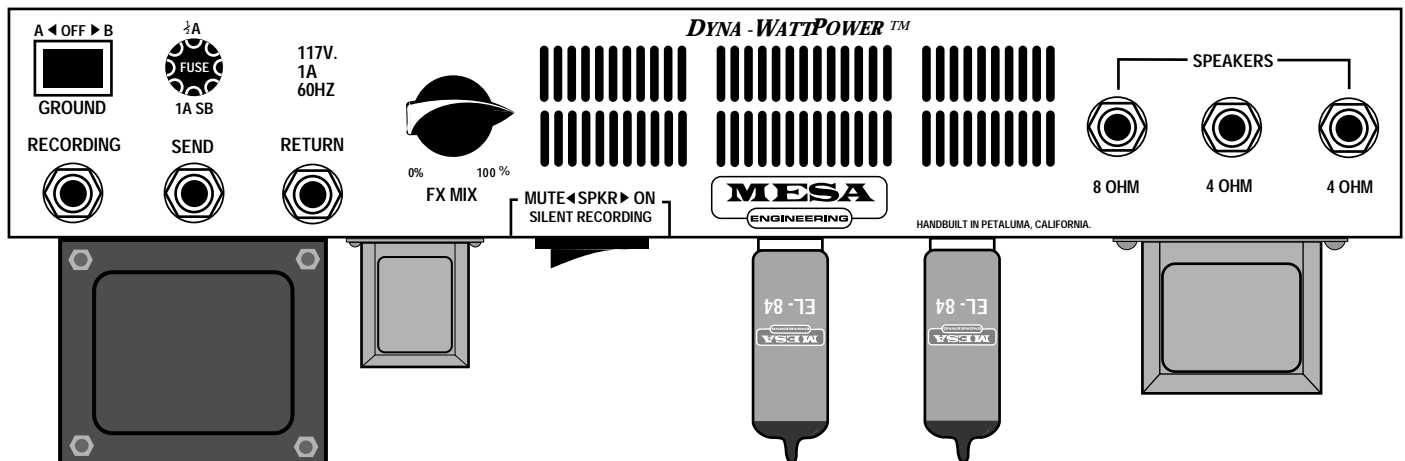
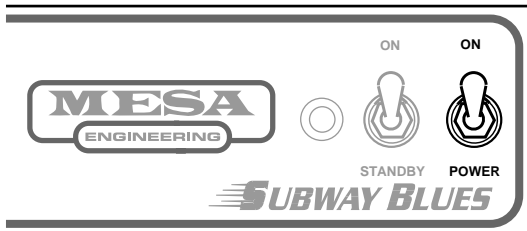

Precautions	0
Overview	1

REAR PANEL:

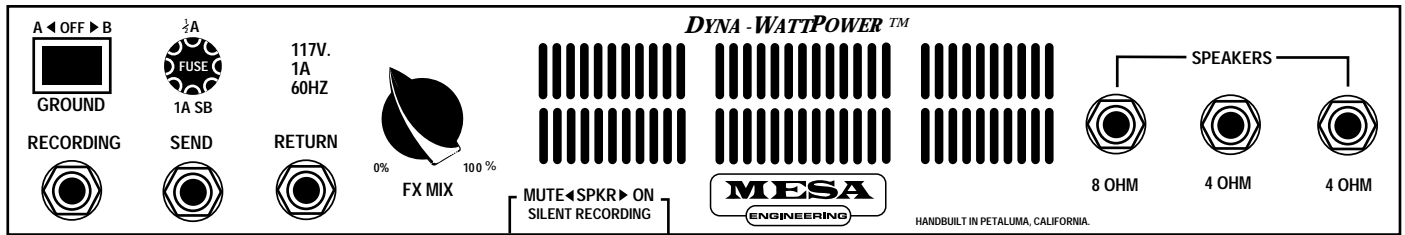

GROUND: This switch reverses the polarity of the A.C. GROUND. It can be helpful in eliminating annoying hum or A.C. buzz as well as those painful microphone shocks. It should be left in the center “OFF” position when neither of these problems are occurring.

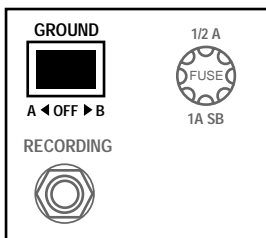

FUSE: This is the A.C.’s (Alternating Current) main FUSE and provides electrical current protection from outside A.C. fluctuations, as well as power tube failure damage. Should the FUSE blow, replace it with the same rating in a slo-blo type package. The domestic U.S. version requires a 1 amp slo-blo FUSE. A power tube short or failure is often the cause of a blown FUSE...Follow the cold start procedure mentioned in the ON / STANDBY switch section and watch the power tubes as you turn the STANDBY to the ON position. If a power tube is going bad or is arcing you will see it! Flip the STANDBY switch to STANDBY immediately and replace the faulty power tube and the FUSE if necessary. If you see nothing abnormal as you lift the STANDBY, it is possible that a power tube shorted temporarily and blew the FUSE. If this is the case it may work again normally. To be extra safe you may want to replace all power tubes in the “shotgun” troubleshooting tradition and save the replaced set as spares.

NOTE: Like tires on a car, spare FUSES are always a measure of good insurance. Your SUBWAY BLUES amplifier was carefully constructed with reliability in mind! Given the proper care and maintenance, it will deliver years of trouble free service. However, any pro guitarist who gigs a lot will tell you; spare FUSES are a must for the fabled cord bag and may someday be worth their weight in gold. Spare tubes are also a very easy way to ensure an uninterrupted performance.

RECORDING: This jack provides direct-to-console interfacing for recording or sound reinforcement applications. It is a circuit dedicated to reproducing the roll off that occurs in the output section with a speaker connected. With accuracy, it faithfully captures the SUBWAY’S soulful character.

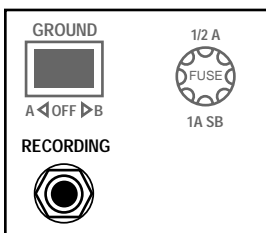

The send level strength is determined by the VOLUME (Gain) control. From this recording jack, adequate signal level will be available for most of your recording or live direct sound reinforcement needs.

Precautions	0
Overview	1

REAR PANEL:

FX LOOP : SEND & RETURN: These two 1/4" jacks are the patch point for external processing effects. The FX LOOP is wired in parallel with the normal signal. Connect the Send jack to your Effects Input jack. Connect the Return jack to the Output jack of your effect. The FX LOOP is a patch point between the pre-amp and power section. Therefore, the Return jack can double as a "Power Amp Input" jack. (MIX control level should be set to 100% for this application.)

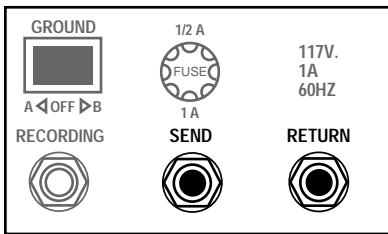

FX MIX: This control determines the dry/wet blend of the FX Loop signal in relation to the unaffected signal. Set to 0% you will experience only the dry signal (no effect) and at a setting of 100% the entire signal will be wet (total effect.)

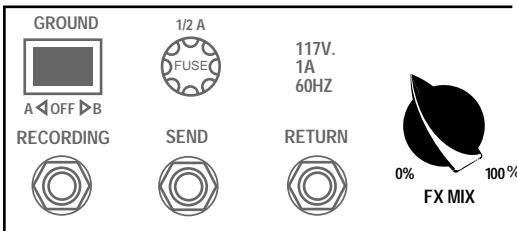

For the best results...Set the mix of your effect to 100% wet. Then dial in the amount of effect that you wish to hear, starting at 0% with the FX LOOP MIX control. The drier (closer to 0%) signal you use, the better your tone should be. This is one of the advantages in having a parallel type FX Loop designed into your SUBWAY amplifier. This circuit allows the amplifier to retain its purity with the least possible degradation due to effects impedance mismatching.

SILENT RECORDING: This rocker switch which is located down under the chassis and selects between the live "SPKR ON" setting and the silent "SPEAKER MUTE" setting. This is a perfect solution for all-nighters! This switch mutes all of the signal at the power section driver stage, removing the need for a speaker load IN THIS POSITION ONLY!

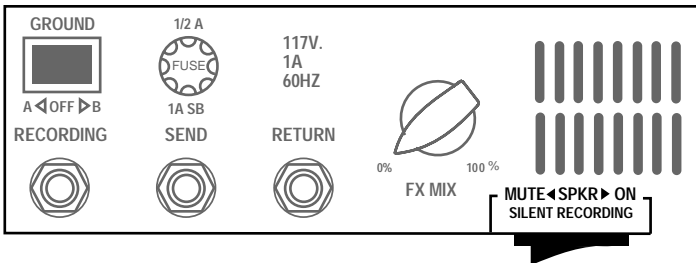

NOTE: When this switch is set to the "ON" position, a speaker load must be maintained by either a load resistor (8 ohms or 4 ohms and rated at least 30 watts power capacity, or a speaker itself.) Failure to comply with this instruction could result in major damage to the amplifier. Leave your speaker connected.

SPEAKER: Sensitivity to SPEAKER mismatching in regards to ohmage differences is low, as long as a load is used at all times. Hence no damage to the amplifier will occur. However, very low ohmage loads will cause the power tubes to wear faster. The SUBWAY BLUES is equipped with a single 10 inch 8 ohm SPEAKER, but as you can see, other SPEAKER configurations may be used. When using two 8 ohm SPEAKER, use the 4 ohm jacks, this will insure proper impedance matching. MESA/Boogie 4X12 and 4X10 cabinets come standard wired to 8 ohms. They have four 8 ohm SPEAKERS wired in series-parallel.

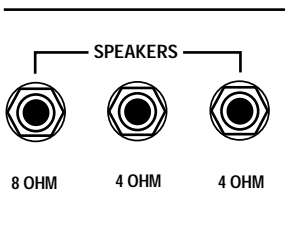

Some cabinets other than MESA/Boogie, may be 4, 8 or 16 ohms. To confirm how your cabinet may be wired and the impedance rating of your SPEAKERS, you may need to remove the back panel to verify this information in regards to proper SPEAKER matching. Feel free to experiment with the SPEAKER jacks, trying different loads. Keep in mind the greatest clean headroom is always achieved with proper impedance loads...i.e. an 8 ohm SPEAKER connected to an 8 ohm jack.

Precautions	0
Overview	1

SUBWAY BLUES

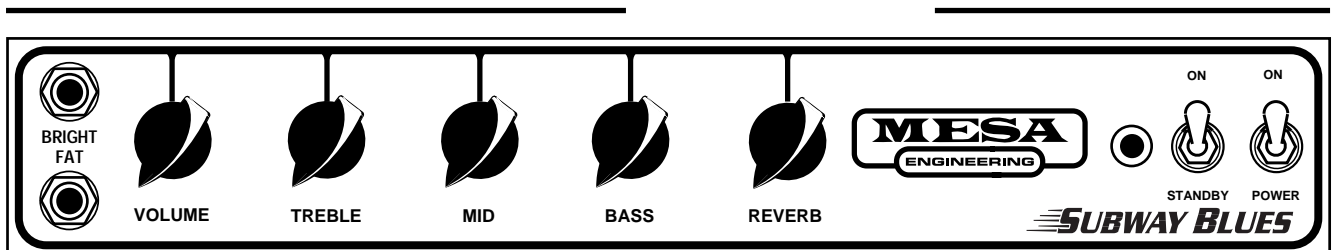
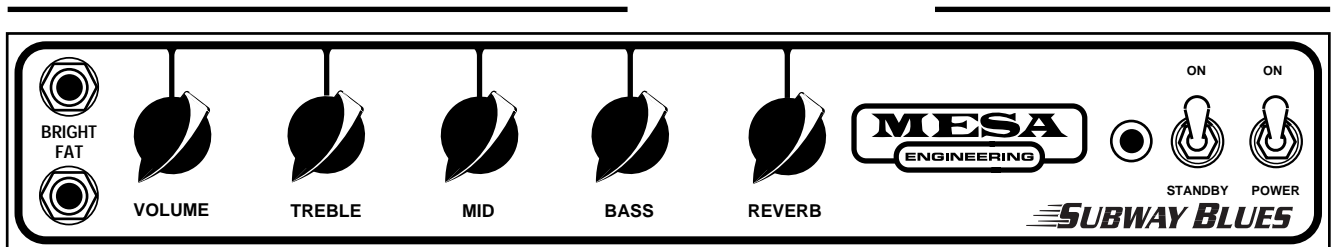
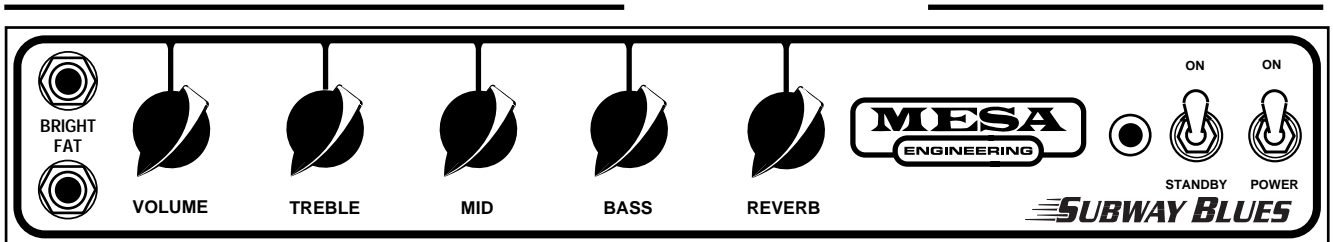
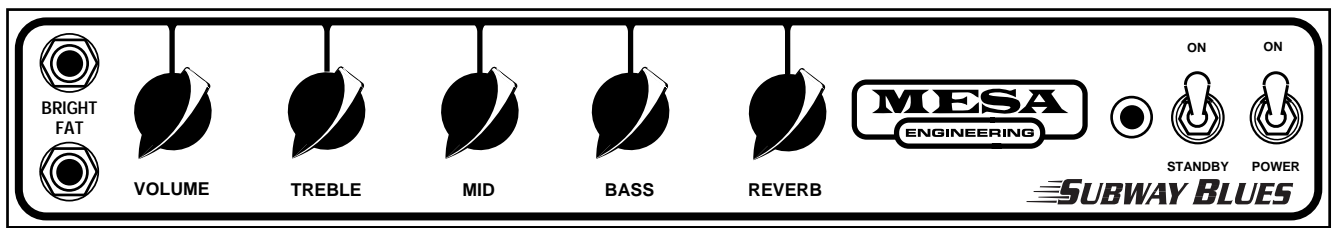

Precautions	0
Overview	1

TUBE NOISE & MICROPHONICS:

You may occasionally experience some form of tube noise or microphonics. Certainly no cause for alarm, this quirky behavior comes with the territory and the Tone. Much like changing a light bulb, you don't need a technician to cure these types of minor user serviceable annoyances and in fact, you'll be amazed at how easy it is to cure tube problems...by simply swapping out a pre-amp or power tube!

First may we suggest that you set the amplifier up on something so that you can get to the tubes comfortably without having to bend down. It also helps to have adequate lighting as you will need to see the tube sockets clearly to swap tubes. Use caution and common sense when touching the tubes after the amplifier has been on as they May Be Extremely Hot! If they are hot and you don't want to wait for them to cool off, try grasping them with a rag and also note that the glass down around the bulbous silvery tip is considerably less hot which makes it easier to handle. Gently rock the tube back and forth as you pull it away from its socket.

DIAGNOSING POWER TUBE FAILURES: There are two main types of tube faults: shorts and noise. Both large and small tubes may fall prey to either of these problems but diagnosis and remedy is usually simple.

If a fuse blows, the problem is most likely a shorted power tube, Shorts can either be mild or severe. In a mildly shorted tube the electron flow has overcome the control grid and excess current flows to the plate. You will usually hear the amp become distorted and begin to hum slightly. If this occurs, quickly look at the power tubes as you switch the amp to STANDBY and try to identify one as glowing red hot. It is likely that two of a pair will be glowing since the "shorted" tube will pull down the bias for its adjacent mates, but one tube may be glowing hotter — and that one is the culprit. The other two are often fine — unless they've been glowing bright red for several minutes.

Because there is no physical short inside the tube (just electrons rioting out of control) merely switching to STANDBY for a few moments then back to ON will usually cure the problem... at least temporarily. Watch the tubes carefully now. Should the problem recur, the intermittent tube will visibly start to over heat before the others and thus it can be identified. It should be replaced with one from the same color batch, shown on its label. Call us and we will send one out to you.

The severe short is not nearly so benign. In the worst cases, a major arcing short occurs between the plate and the cathode with visible lightning inside the glass and a major noise through the speaker. If this is seen to happen, IMMEDIATELY turn the amp to STANDBY. By this time the fuse probably will have blown. Such a short is usually caused by a physical breakdown inside the tube including contaminate coming loose or physical contact (or near contact) between the elements. Replace it and the fuse with the proper slo-blo type and power up the amp using the power up procedure as we described earlier in this manual.

TUBE NOISE:

Often caused by contamination within in a tube, the culprit can usually be identified, and by lightly tapping on the glass, you will probably hear the noise change. Hearing some noise through the speakers while tapping on the 12AX7's is normal however. And the one nearer the input will always sound louder because its output is being further amplified by the second 12AX7.

The power tubes should be all but quiet when they are tapped. If crackling or hissing changes with the tapping, you have probably found the problem. To confirm a noisy power tube, merely put the SUBWAY BLUES on STANDBY, remove it from its socket and turn it back on. It will cause no damage to run the SUBWAY BLUES briefly with one power tube missing. You may notice a slight background hum, however, as the push-pull becomes unbalanced. Whenever you are trying to diagnose a suspect tube, keep your other hand on the Power and Standby switches ready to shut them off instantly in the unlikely case you provoke a major short. If you think you've located a problem tube but aren't sure, we recommend substituting the suspect with a new one just to be sure of your diagnoses. You will be doing yourself and us a big favor by just following the simple guidelines previously mentioned regarding tube replacement. You'll probably be successful with much less effort than is required to disconnect everything and haul the unit to a technician who will basically perform the same simple tests. If the tubes are still within their six-month warranty period, we will happily send you a replacement. Just note the color designation on the tube label so that we can send you the appropriate match.

Precautions	0
Overview	1

DIAGNOSING PRE-AMP TUBE PROBLEMS:

Because your amplifier is an all tube design, it is quite possible that you will at some point experience minor pre-amp tube noise. Rest assured - this is no cause for alarm and you can take care of the problem yourself in a matter of minutes by simply swapping tubes.

Let us begin by saying; It is a “very good” idea to keep at least a couple of spare pre-amp tubes on hand at all times to insure uninterrupted performance. These minor pre-amp tube problems can take many forms but can generally be described in two categories: Noise and Microphonics, Noise can be in the form of crackling, sputtering, white noise/hiss and/or hum. Microphonic problems usually appear in the form of a ringing or high pitched squealing that gets worse as the gain or volume is increased thus are more noticeable in the higher gain Lead modes. Microphonic problems are easily identified because the problem is still present even with the instruments’ volume off or unplugged altogether - unlike pick-up feedback which ceases as the instrument is turned down. Microphonic noise is caused by mechanical vibration and shock: think of banging a microphone around and you’ll understand where the word came from. The best way to approach a pre-amp tube problem is to see if it occurs only in one specific mode or channel. Then refer to the Tube Task Chart found on page 15 and it should lead you to the tube needing replacement. Then all that remains is to swap the suspect tube for a known good performer.

If you cannot narrow down the trouble to a specific mode or channel, the problem may be the small tube that drives the power tubes which is operational in all modes and channels. Though rare, a problem with the driver tube would show up in all aspects of performance - so if you can’t narrow the problem down to being mode or channel specific, you may want to try replacing the driver tube. Driver problems generally show themselves in the form of crackling or hum in all modes of performance and/or weak overall output from the amplifier. Occasionally an anemic driver tube will cause the amplifier to sound flat and lifeless, but this is somewhat uncommon, as worn power tubes are a more likely suspect for this type of problem.

Sometimes making the diagnosis is more trouble than it’s worth and it’s faster and easier to merely replace the small preamp tubes ONE AT A TIME with a replacement known to be good. But MAKE SURE you keep returning the tubes to their original socket until you hit the one that cures the problem. You’ll notice that tubes located nearer to the Input jacks always sound noisier...but this is because they are at the start of the chain and their noise gets amplified over and over by the tubes that follow. The tube that goes into this “input socket” (usually labled V1) needs to be the least noisy of the bunch. The tube that goes at the end of the preamp chain - just ahead of the power tubes - can be quite noisy without causing any problem at all. The tubes in your amp have already been located in the most appropriate sockets and this is why you should NEVER pull them all out at once and ALWAYS swap them one at a time. ALWAYS return a perfectly good tube to its original socket. Also it’s a good idea to put the amp on standby when swapping tubes to reduce the heat build up in the tubes themselves and to prevent explosive noises (which can still occur even if you are pulling the tubes away from their sockets gently) from coming through the speaker.

Remember, take your time, be patient and chances are real good that you can fix your amp yourself by finding and replacing the bad tube. It kills us to see someone who has shipped their amp back to us...and all it needed was a simple tube replacement!

If you must send back your amp, unplug the power cord, speaker and reverb cables then remove the chassis from the cabinet by unscrewing the four mounting bolts on top. The chassis then slides back like a drawer and comes out. Remove the big power tubes and mark them according to their location from left to right 1, 2 etc. They need to be wrapped separately with plenty of wadded up newspaper around them and put in a smaller box within the larger carton. To wrap the chassis, use plenty of tightly wadded up newspaper so there is at least six inches of “crush space” between the chassis and the cardboard box. Bubble wrap also works well but please DON’T use styrene peanuts - they will shift during transit and get lodged inside your electronics as well as allowing your amp to end up at the bottom of the box unprotected and possibly damaged.

Preamp tubes don’t normally wear out as a rule. Therefore, it is not a good idea to change them just for the sake of changing them. If there isn’t a problem - don’t fix it. If there is no result from your substitutions, it may be possible that you have more than one problematic tube. Though rare, this does happen and though it makes the troubleshooting process a little more intimidating, it is still possible to cure the problem yourself.

NOTE: It is normal to hear a slight metallic ringing sound when tapping on the preamp tubes. As long as the tube does not break into oscillation or start crackling or any other form of bizzare noise, it is considered normal and functional.

Precautions	0
Overview	1

BIAS ADJUSTMENT: (Part of a continuing series)

NOTE: An article written by Randall Smith that we thought you might find interesting.

Here's a question we often hear:

"Why doesn't Mesa put bias adjustments in their amplifiers?"

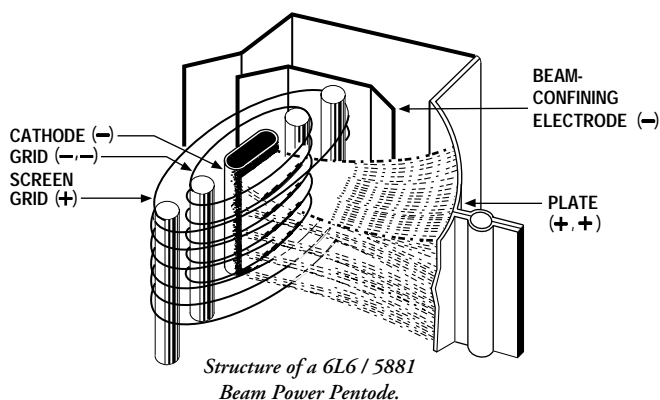

Well, there's a short answer and a long answer to this question.

The short answer is that during my 12 years of repairing Fenders, one of the most frequent problems I saw was bias controls that were either set wrong or that had wandered out of adjustment due to vibration. As any honest tech will tell you, there's lot's of easy money to be made by sprinkling "holy water" on amplifiers ... uh, what I meant to say is "Your amp needed biasing." See what I mean? What customer is going to argue with that?

It only takes a moment and a volt meter: The Fender diagram shows how: "Adjust this trim pot for - 52 volts." That's it. Nothing more.

Now don't be fooled into thinking that tubes "draw" more or less bias, they don't. The way a bias supply is connected to a tube is akin to a dead end road, it just trails off to nowhere without really completing a circuit. It's a static voltage and regardless of what tube is in the socket — or even if the tubes aren't plugged in at all, it doesn't change the bias voltage a bit.

So the end of the short answer is this: Since a bias supply needs to put out the right voltage and never vary, I wanted to build amplifiers that were individually hard wired to the correct values and NEVER needed adjustment. And for 25 years, that's how Mesa/Boogies have been built.

Time to change tubes? Just plug our tubes into any one of our amps and you're DONE. No tech needed. NO bills and no BS about biasing. And most important: The bias is RIGHT because it can't change!

Now, you want the long answer? Here's more information on how our hard-wired bias avoids trouble. Please read on.

But first, let's make an important distinction. Our business is designing and building high performance amplifiers. And for this we need tubes whose variance is within a narrow range. Our warehouse is full of rejects ...oh, they work — they just don't perform within our tolerance range. We have a very sophisticated computer - based tube testing system (nicknamed "Robotube") that matches and measures tubes over seven important parameters. It can even predict which tubes are likely to have a shortened lifetime — even though they work perfectly during the test.

Because our business is building quality amps, we can afford to reject a lot of wayward tubes. The guys you hear complaining because Boogies don't have bias adjusters are primarily in the business of selling tubes - not amps. They don't want to throw away 30 percent of their inventory, so they promote the idea that tubes outside our parameters can be used to "customize" amplifiers and they criticize us because our amps can't be adjusted to accommodate their out-of-Mesa tolerance tubes.

Now you might be thinking, "But I thought you just said that tubes don't "draw" bias, therefore they don't effect the bias supply and thus it doesn't need to be adjustable."

And that's right. Tubes don't effect the bias setting, but how it effects the tubes is difficult to measure.

When you set the bias (whether it's by selecting the right resistors, as we do, or adjusting a trimmer — which is quicker) what you are

Precautions	0
Overview	1

BIAS ADJUSTMENT (Continued) doing is establishing the correct amount of idle CURRENT that flows through the power tubes. But you can't adjust the current directly, you can only change it by adjusting the amount of bias VOLTAGE that goes onto the tubes' control grids.

Voltage and current are NOT the same. Current is the AMOUNT of electricity, the "quantity" — and is measured in amperes. Voltage is the degree of electric charge — like the "pressure" to use the old water analogy. Let me illustrate how different voltage and current are:

When you scrape your feet across a carpeted floor in dry, wintery conditions, your body can become charged with 50,000 to 100,000 volts of static electricity. And when you reach for the door knob, a spark jumps and you feel it! The voltage is super high but the current (measured in micro-amps) is tiny - otherwise you would die from electrocution.

Contrast this with your car battery, which puts out a mere 12 volts. You can lay your hands right across the terminals and not feel a thing. Yet the amount of current available can run to several hundred amperes .. enough to turn over a cold engine and get it started.

So current and voltage are two totally separate electrical parameters — though when you multiply them together, you get POWER, which is measured in watts.

When you set the bias of an amplifier, you are adjusting the static VOLTAGE at the control grid of the tube in order to produce a desired amount of idle CURRENT flowing to the tube's plate. A small change in grid voltage, produces a large change in the amount of current flowing — and that's basically how a tube works. Say that again because it's super important: A small change in voltage at the grid causes a large change in current flowing to the plate. See, that's the essence of amplification: A small change causing a large change. And here it's a small voltage change causing a large current change.

The bias conditions are what determines how much current flows through the big power tubes when you're not playing. And what drives your speakers is fluctuations in that current flow when are playing. If the amount of current increases and decreases 440 times per per second, then you'll hear an A note. If the fluctuations in current flow are large and still at 440 per second, you'll hear an A that is loud!

But for purposes of biasing, it's the amount of "plate current" flowing with no signal applied that's important. Unfortunately current is hard to measure because the circuit must be interrupted — as in "cut the wire" — and the meter spliced "in series" with the broken circuit. But measuring VOLTAGE is easy. It is not necessary to interrupt the circuit because a voltage reading can be taken in parallel with the circuit intact.

Thus, as a matter of convenience, most bias settings are given in volts at the grid ... even though current through the plate is the important factor. In fact plate current is so inconvenient (and dangerous) to measure that Fender doesn't even state what the correct value should be. They only give the grid voltage that will produce that current. (That's the minus 52.) But that only happens if the tubes being used are "in spec."

As long as the tubes are "in spec", the right bias voltage will always give the correct plate "current" — but then there's no need for the bias voltage to be adjustable! If the tubes are not in spec, then the only proper way to re-set the bias is to cut the circuit and measure the current while adjusting the bias ... but no manufacturer I know even states the desired current value! Be that as it may, when the original bias voltage is altered far enough, it will compensate for the tube's abnormal performance and the correct amount of idle current flow may then be restored. Clearly this is something most repair techs should not attempt.

Some newer amps have LED indicators connected to the circuit which will turn on when the right threshold of current flow has been reached. This is an improvement, and almost worthy if you're willing to except resistors and lights added into your amplifier's audio path — which we aren't. The other "advantage" of this system is that it allows some amp manufacturers to avoid matching their power tubes. The thinking is that adjusting the bias to each tube separately eradicates the inherent differences between the tubes by insuring that the same current flows through each one.

Again, this has some merit ... but it's still not as good as using tubes that are matched in the first place because compensating for the mis-match causes the push-pull circuit itself to become unbalanced. Two wrongs don't really make a right.

Precautions	0
Overview	1

Some of the other recommended biasing, “methods” — such as -“.. tubes running red hot, increase the bias .. sounds harsh and runs too cool, turn it down ...” are guesswork at best. Luckily, one of the great things about tube amps is that they can usually stand some abuse without causing any real harm ... at least not immediately.

But don't these alterations imply that you are second-guessing the amp designer and that there's a better set of operating conditions that the designer missed but the tube sellers have discovered?

Now some players may like the sound of their amp altered by tubes with extreme characteristics and with the bias set to help compensate. But often it is the mere novelty of change that they're really responding to and when the amp goes back to the proper original way, we've seen them be far happier still!

Because every part in every one of our designs has been meticulously evaluated, compared and stressed over — no matter how seemingly insignificant it might be. And with every design we look for a “sweet spot” where all the parameters — including the bias — come together to give the best sonic performance, consistently and reliably. Every part and voltage is important — yet no one complains that these other parameters aren't available for tinkering.

Consider our patented Simul-Class circuitry where there are two different bias voltages used for separate pairs of power tubes ... and changing one voltage also changes the other. Great care goes into getting this just right and we think we'd be asking for trouble to have it adjustable for the world to play with ... unless you like paying to have your amp messed up. Sorry, I meant to say, “Uh, ... your amp needed biasing.”

If that doesn't appeal to you, then merely plug a matched set of Mesa tubes into one of our amps and you're ready for tone. Guaranteed. You'd be amazed at the number of service calls we field every day that lead to a diagnosis of out-of-tolerance, non-spec tube problems. To think these would be prevented by including a bias adjustment is something of an insult to you and us. If you put the wrong size tires on your car, do you think changing the pressure will make them right?

Please, don't think this is a blanket indictment of the other guys selling tubes — it isn't. And their tubes aren't all bad either. It just doesn't make sense to pay more of your hard earned cash for tubes that were probably made in the same Russian or Chinese factory and which have the possibility of being outside the performance window we select for your amp. And it pains us to hear the hype and mystique built up around biasing when twenty-five years of evidence affirms our decision to make bias circuits that “never need adjustment”. How much money and trouble that has saved Mesa/Boogie players you couldn't estimate.

Our rigorously tested and hand selected tubes are available at your nearest Mesa/Boogie Pro Center or from us directly. Nobody offers better price, quality or warranty than we do ... so why swerve?

Next time we'll talk about our part in developing the great Sylvania STR 415 type 6 6 and how we're on the verge of seeing something fairly close reappear on the market. Remember, we still have some of these super rugged mondo-bottles available for older amps — Boogies only please! Until then, Relax, Breathe and Nourish your soul!

Cheers!
Mesa/Boogie Ltd.

Randall Smith
Designer & President

Precautions	0
Overview	1

FRONT VIEW *SUBWAY ROCKET*

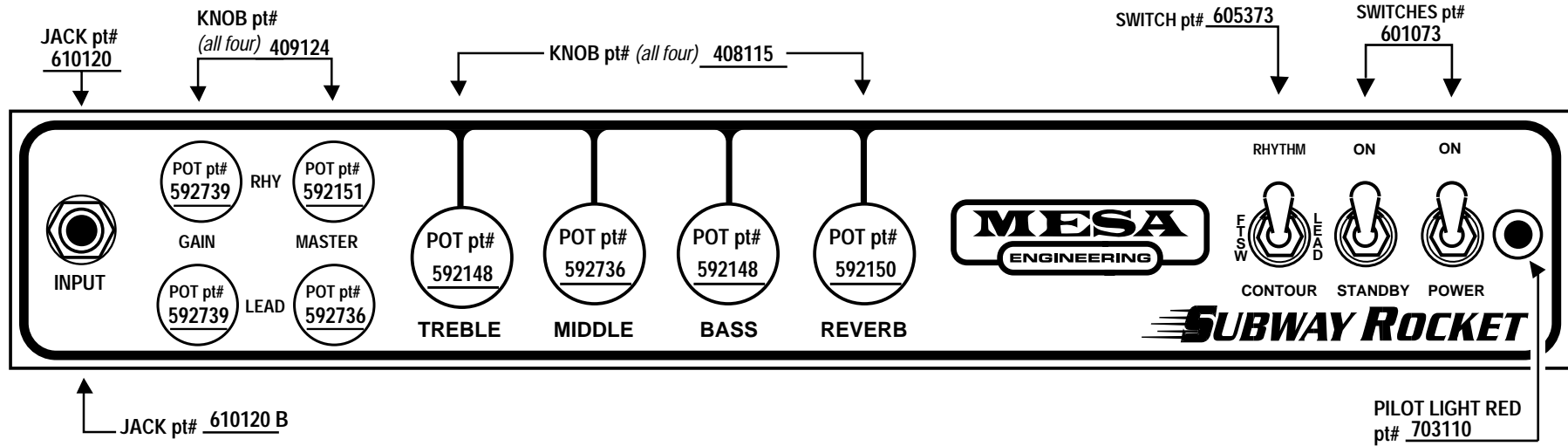

REAR VIEW *SUBWAY ROCKET*

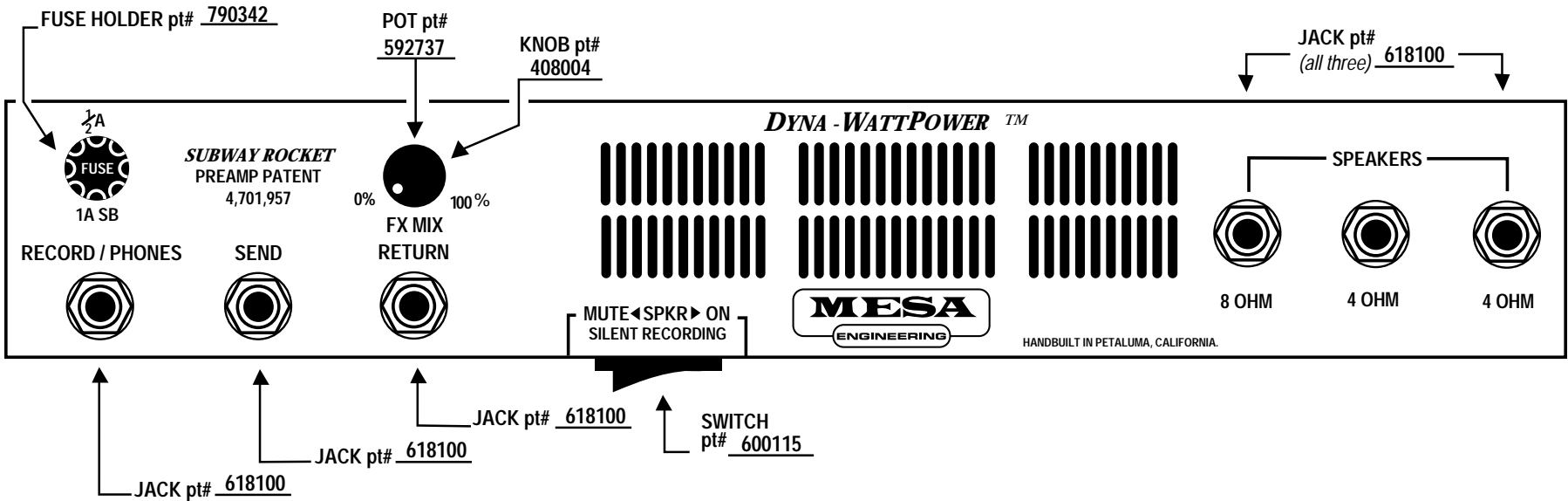

MESA/BOOGIE[®]

The Spirit of Art in Technology

Thank you for trusting MESA/Boogie to be your amplifier company. We wish you many years of toneful enjoyment from this handbuilt all tube instrument.



The Spirit of Art in Technology



*1317 Ross Street Petaluma, CA 94954
USA*