

MESA/BOOGIE

20/20

Owner's Manual

The Spirit of Art in Technology

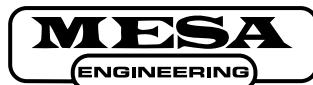

***1317 Ross Street Petaluma, CA 94954
USA***

Hello from the Tone Farm...

YOU, the smart player and all around intuitive human, have put your trust in us to be your amplifier company. This is something we do not take lightly. Our reward is that we've made a classic amplifier and by choosing this amplifier, you have become part of the MESA family...Welcome! Our goal is to never let you down. Your reward is that you are now the owner of the all new 20/20 power amp, bred of fine all tube amp heritage...benefiting from the many patented pioneering MESA/Boogie circuits that led to the refinement of your new instrument. Feel confident, as we do, this product will inspire many hours of musical satisfaction and lasting enjoyment. It was built with you in mind, by players who know the value of a fine musical instrument and the commitment it takes to make great music. The same commitment to quality, value and support we make to you...our new friend.

20/20

TABLE OF CONTENTS

Precautions	
Overview _____	1
Instant Gratification Hook-Up _____	2
FRONT PANEL CONTROLS:	
Presence _____	3
Volume _____	3
Power _____	3
Standby _____	3
Fuse _____	4
REAR PANEL FEATURES:	
Instrument Input A / B _____	4
Speaker Jacks _____	4 / 5
Slave _____	5
Tube Task Chart _____	6
Personal Setting Pages _____	7
Parts Sheet _____	8

Your Mesa/Boogie Amplifier is a professional instrument. Please treat it with respect and operate it properly.

USE COMMON SENSE AND ALWAYS OBSERVE THESE PRECAUTIONS:

- Do not expose amplifier to moisture, rain or water, direct sunlight or extremely high temperatures.
- Always insure that amplifier is properly grounded.
- Always unplug AC power cord before changing fuse or any tubes.
- When replacing fuse, use only same type and rating.
- Avoid direct contact with heated tubes.
- Insure adequate air circulation behind amplifier.
- Keep amplifier away from children.
- Be sure to connect to an AC power supply that meets the power supply specifications listed on the rear of the unit.
- If there is any danger of lightning occurring nearby, remove the power plug from the wall socket in advance.
- To avoid damaging your speakers and other playback equipment, turn off the power of all related equipment before making the connections.
- Do not use excessive force in handling control buttons, switches and controls.
- Remove the power plug from the AC mains socket if the unit is to be stored for an extended period of time.
- Do not use solvents such as benzene or paint thinner to clean the unit. Wipe off the exterior with soft cloth.
- Be sure to have the warranty card filled out by the store at which you purchased this product and send back to Mesa Engineering.

YOUR AMPLIFIER IS LOUD! EXPOSURE TO HIGH SOUND VOLUMES MAY CAUSE PERMANENT HEARING DAMAGE!

No user serviceable parts inside. Refer service to qualified personnel. Always unplug AC power before removing chassis.

EXPORT MODELS: Always insure that unit is wired for proper voltage. Make certain grounding conforms with local standards.

READ AND FOLLOW INSTRUCTIONS OF PROPER USAGE.

20/20

Operating Instructions

OVERVIEW:

Congratulations ...you have just become the owner of the most "Tone Full" one and three quarters inches of rack guitar power available on today's market. Don't let the one rack space size fool you - this small amp packs a BIGGER than life voice and has been designed to handle all of what you'd expect and probably more from an amp this size. Though it weighs in at 20 watts per channel, grueling tone and headroom test confirm its authority even against amps boasting twice its rated power and yes...bulk. As with many of its Boogie cousins - the concept "Shrink the package - Enlarge the Tone" was in full effect here. If you've already played your 20/20, you know how incredibly big and bold, sweet and juicy it sounds...if you chose it by reputation alone, stop! Put this owner's manual down and a second, connect it to your preamp (hopefully one of our Mesa products) and favorite speaker cabinets (again, hopefully a Mesa product.) Begin the tonal experience so many 20/20 owners rave about immediately! Don't wait! One chord and one note will tell you more about this amp than we could ever say here in print. Besides, you can come back and read this the day after tomorrow - when your finger's are too sore to play anymore - and you can better enjoy this manual with a blown mind and your previous idea of tone well rocked!

The 20/20'S power sections are fueled by two pairs of EL-84 power tubes wired for Dyna-Watt response which unleash touch-sensitive dynamic punch far in excess of their twenty watt per channel rating. This is what happens when Dyna-Watt's stored energy is released like a camera flash and controlled by your picking technique/style. With enough fan-cooled power to cover small venues, the 20/20 can also double as the power-amp "tone generator" in bigger rigs. The Two Stereo Slave jacks located on the Rear Panel marked SLAVE A - B allow you to capture the sound of a great small amp's musical clip. Two speaker jack combinations have been provided...two 8 Ohm (left & right) and two pairs of 4 Ohm jacks (respectfully labled left & right) ensure the proper impedance match to many types of speaker enclosures.

While remaining straight forward and simple to operate, the 20/20 All Tube Stereo power amplifier is sure to measure up to all your musical expectations and provide you with many hours of toneful bliss. Thanks again for letting us be part of your musical journey, Enjoy!

FRONT VIEW: 20/20

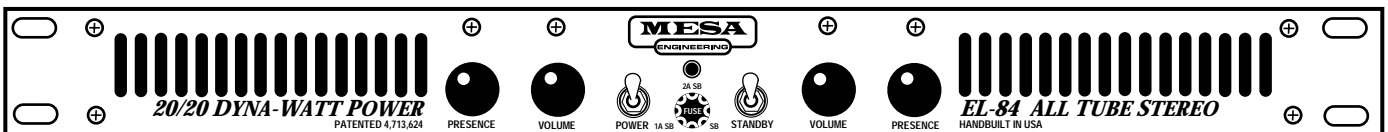

REAR VIEW: 20/20

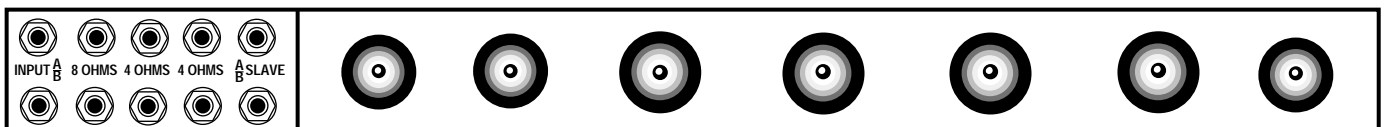

Instant Gratification Basic Hook-Up Diagram:



Front Panel of *Mesa/Boogie* Formula Pre-Amp

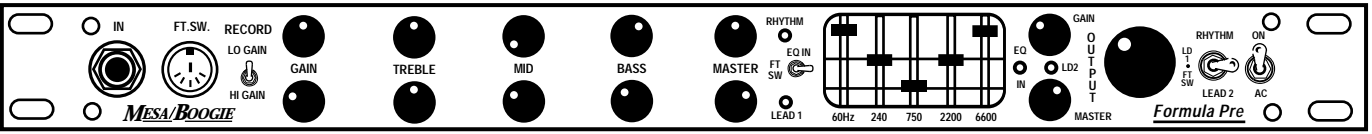

Back Panel of *Mesa/Boogie* Formula Pre-Amp (partial view)

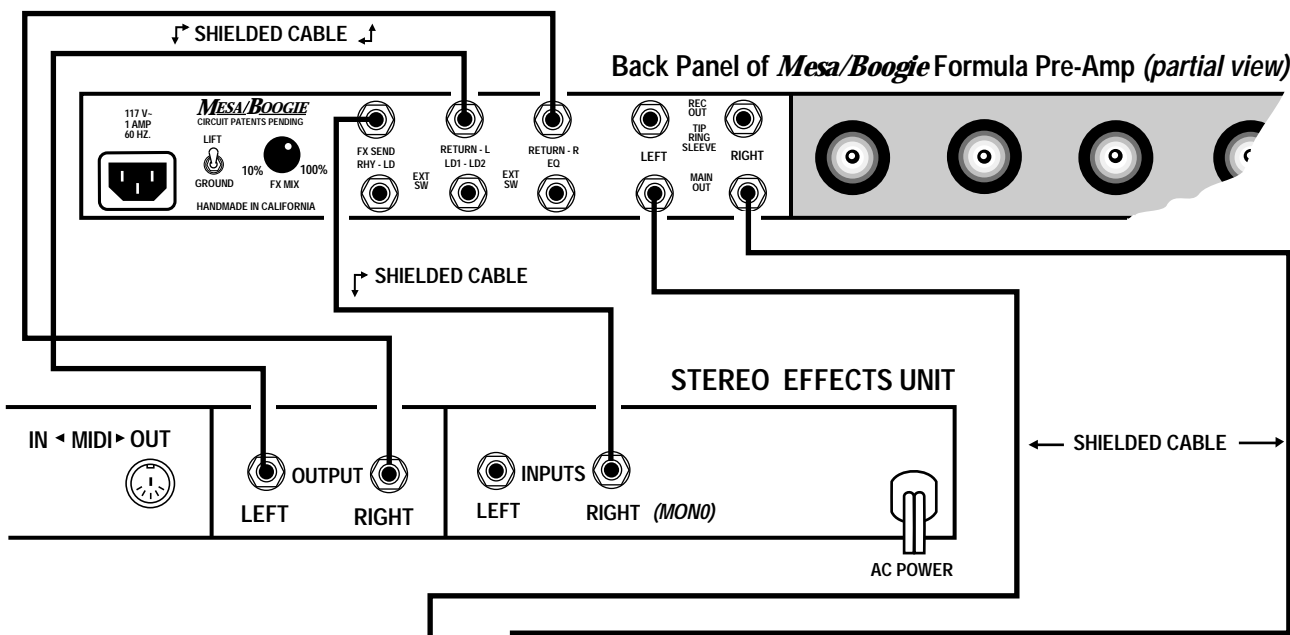

Rear Panel of *20/20* Power Amp (partial view)

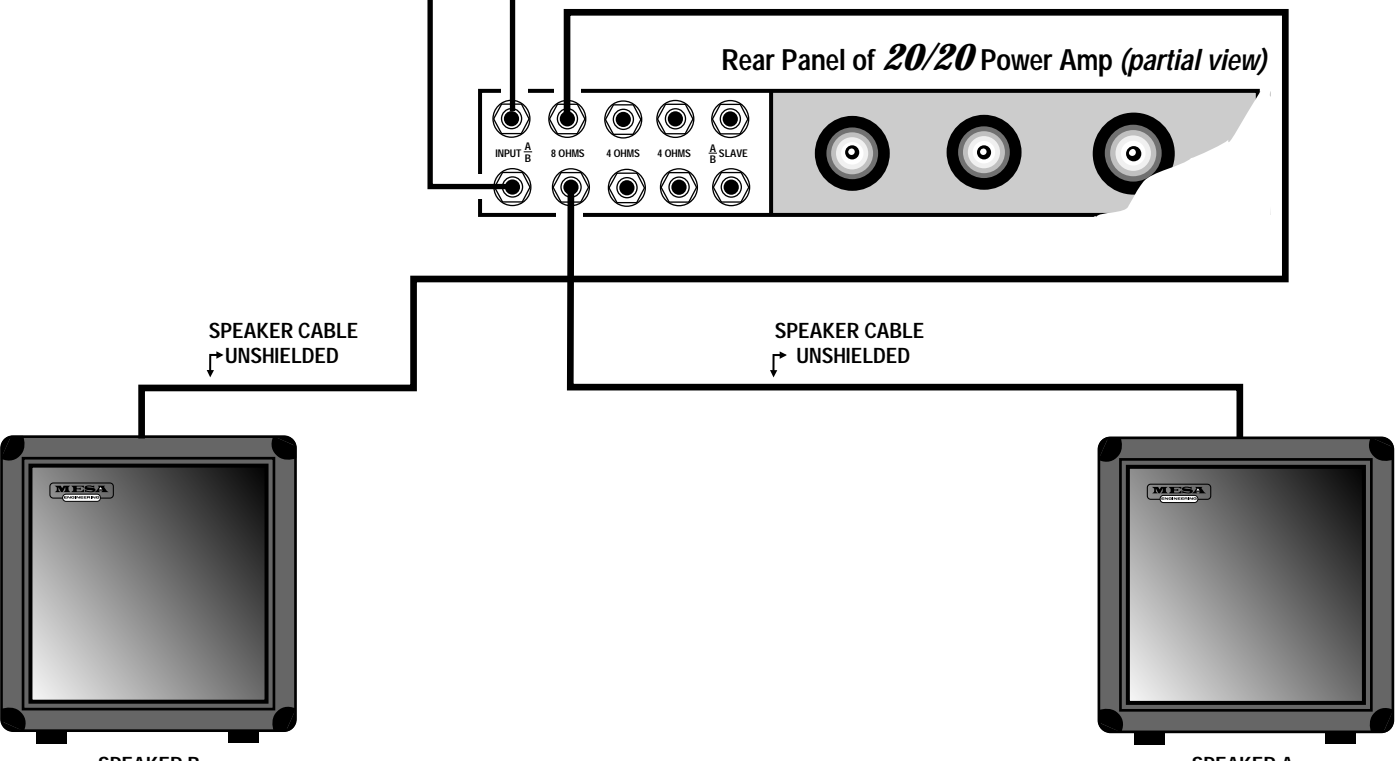

SPEAKER B

SPEAKER A

FRONT PANEL CONTROLS:

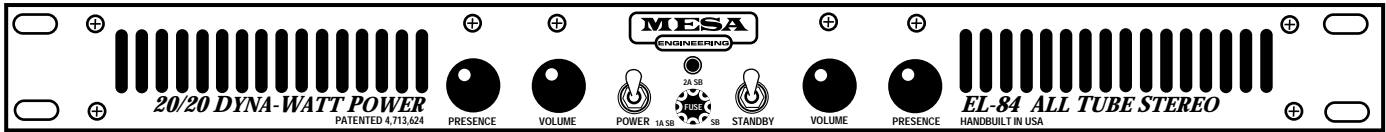

PRESENCE: These controls “open-up” the 20/20 producing brightness and sparkle for clean sounds at higher settings or sizzle and edge when set high for distortion sounds. At lower PRESENCE Control settings you can darken and compress lead sounds making them warmer and fatter. Turning the PRESENCE Controls to zero “chokes the brights” completely, making the 20/20 great for jazz clean sounds or round vocal lead work.



VOLUME: These two potentiometers (pots) control the volume level of each side or channel of the 20/20. Since there’s only one Standby switch on this unit, these two controls may be used as channel muting controls.



NOTE: If only one speaker is to be used on one channel and no speaker load is present on the other, always turn the unused channels VOLUME Control to zero. To prevent oscillation (motorboating like sound) turn the PRESENCE Control of that channel all the way up.



POWER & STANDBY: These two toggles located next to the 20/20’s left and right channel VOLUME Controls deliver A.C. Mains voltage and D.C. filament voltage. When powering up cold - make sure the STANDBY switch is in the Standby position when flipping the POWER switch to the ON position. Wait at least 30 seconds before flipping the STANDBY switch to the ON position. This procedure reduces shock on cold tubes and prolongs their toneful tube life. Remembering to use the STANDBY switch on set breaks also prolongs tube life.

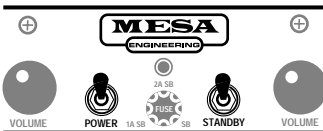

NOTE: Power tube life varies depending on many factors i.e. how much you play, how you treat your equipment etc. We’ve found that most discerning pro’s who use their gear five to seven nights a week start noticing some tone loss somewhere around 8 months to a year. Some people, however, use the same set of power tubes for years with no complaints.

We recommend changing your power tubes once a year if you play alot. This way you’re ensured of smooth operation and optimum tone. Always use Mesa power tubes of matching color codes whenever possible. These are matched correctly with each other and hammer tested and actually cost less than the so called matched competitors in most cases. Also, it keeps your 20/20 warranty intact.

FRONT PANEL CONTROLS: (Continued)

FUSE: This is the A.C.'s (Alternating Current) main fuse and provides protection from outside A.C. fluctuations as well as power tube failure damage. Should the fuse blow, replace it with the same rating in a Slo-Blo type package. The domestic U.S. version requires a 2 amp Slo-Blo fuse. A power tube short or failure is often the cause of a blown fuse...Follow the cold start procedure mentioned in the POWER & STANDBY switch section and watch the power tubes as you flip the STANDBY switch to the ON position. If a power tube is going bad or is arcing you will see it! Flip the STANDBY switch to Standby immediately and replace the faulty power tube and the fuse if necessary. If you see nothing abnormal as you lift the STANDBY switch, it is possible that a power tube shorted temporarily and blew the fuse. If this is the case it may work again normally. To be extra safe, you might want to replace just the adjacent tube or all power tubes in the "shotgun" troubleshooting tradition and save the replaced set as spares. Spare fuses are a must for the fabled cord bag along with your spare tubes. Always carry both for they could be worth their weight in gold someday.

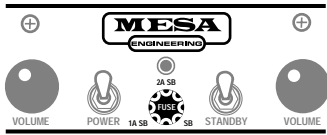

Now that we've reviewed the 20/20'S Front Panel controls and found its simple layout to be easily digested, let's move aft for a review of the Rear Panel connections.

REAR PANEL:

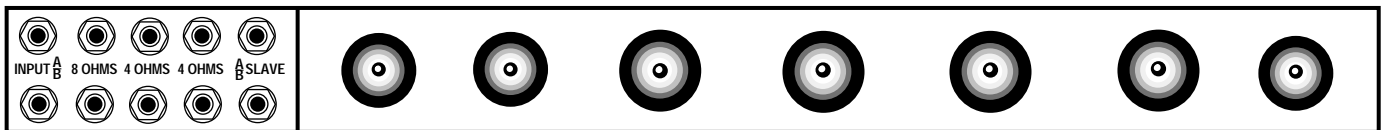

INPUTS A / B: Located to the far left (when facing the unit from the rear) you'll find two 1/4" insulated jacks. These are the inputs for preamps and/or effects, depending on how you wire your system. You may drive the 20/20 with your preamp directly or choose to come from the last effect in a chain and drive the power amp this way. Either way is fine and up to your preference.

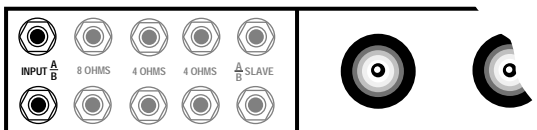

SPEAKERS: These six jacks deliver the 20/20'S incredible tone to your favorite speaker cabinets. One eight Ohm and two four Ohm jacks per channel are provided. Use one eight Ohm cabinet in the eight Ohm jack of each channel and two eight Ohm cabinets into the two four Ohm jacks per channel. Use one four Ohm cabinet into one four Ohm jack (each channel). Use one sixteen Ohm cabinet into the eight Ohm jack (each channel). Two sixteen Ohm cabinets connected with a "Y" cable works even better in the eight Ohm jack, once again this would be the same for each channel.

Don't forget: Duplicate the proper load for both channels: Turn its VOLUME Control to zero and its PRESENCE Control all the way up. It's also best not to send signal to the unused channel input.

REAR PANEL: *(Continued)*

SPEAKERS: *(Continued)* Speaker cabinets may be 4, 8 or 16 Ohms and can vary from one manufacturer to another. If you are not sure of the impedance rating of your cabinet, you may need to remove the cabinet's rear panel in order to verify the impedance rating of the speaker (s). Mesa/Boogie 4x12 and 4x10 cabinets come standard wired to 8 Ohms and are wired in series-parallel. No matter how unusual your speaker setup, it is always possible to get good performance from your 20/20.

SLAVE A / B: The 20/20 provides a pair of slave jacks that enable you to capture the sound of this magic little power section and inject it directly into outboard effects processors or other larger power amplifiers for higher output at larger venues. In either of these scenarios the 20/20 becomes a tone generator that enables you to achieve the sound of a small amp cranked, in a one space rackable format. Due to space considerations, the output levels are preset at the slave output jacks to provide an optimum level when the Front Panel VOLUME Controls are set to approximately 10:30, which is usually just past the onset of clip - depending on the strength of the signal at the Inputs.

This predetermined level of the Slave jacks should be well matched to most applications and some control of the signal level is possible by adjusting the Front Panel VOLUME Controls. If you have an application where you are using the 20/20 at either super low or extremely high for fully clipped sounds, you can call us and ask for a Product Specialist and he can figure out a signal strength resistor network for your individual needs and can send the parts to you for a technician in your area to install. Most likely though, by working with the 20/20's VOLUME Controls in conjunction with the input attenuators of the processor or power amp you are interfacing with, a Slave level can be obtained that will work well for your situation. Please try this before calling us to modify your amp.

NOTE: WARNING ! - A load must be connected at all times to the Speaker Outputs when using the Slave jacks. If you intend to use the 20/20 as a tone generator only and do not want to listen to the live speaker outputs, connect a load resistor with a rating of at least 40 watts (or greater if driven continuously into clip) and with a 4 or 8 Ohm impedance rating. Each channel must have a load resistor connected to its proper speaker jacks. In most cases a speaker will deliver better sound and a tone you are more familiar with due to the reactive nature of a speaker's dynamic signature and natural compression. If you prefer this Slave sound, but don't want to listen to the live speaker simply put it in a box or hide it under the drum riser...etc.

TUBE LAYOUT and TASKS

20/20

REAR PANEL (cut-a-way view looking down from the top of unit)

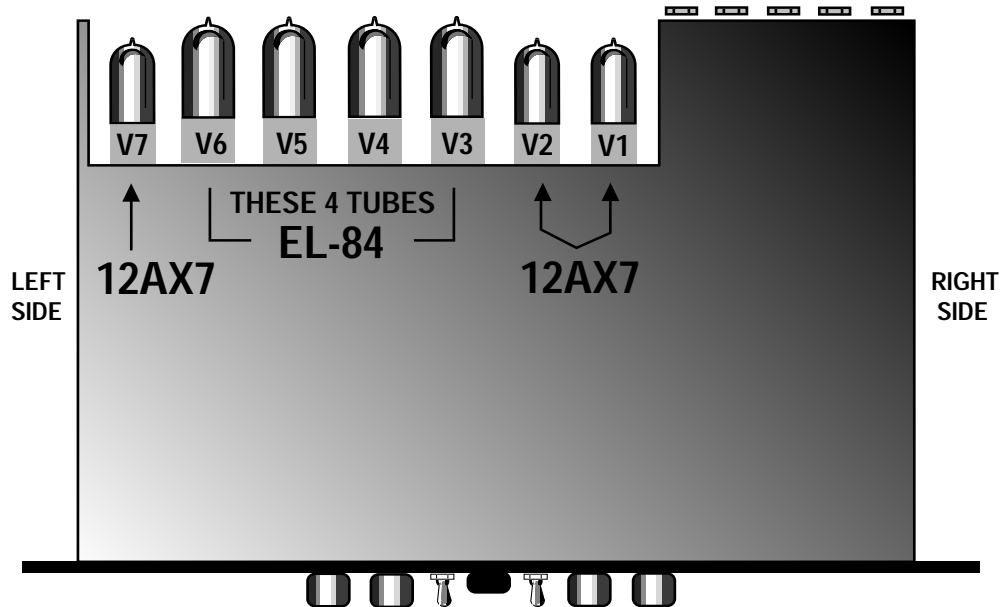

TUBE ASSIGNMENT

V1 - A = Channel B Input Stage
V1 - B = Channel A Input Stage

V2 - A = > Phase Inverter for Channel B
V2 - B = >

V3 = > Power Tubes for Channel B
V4 = >

V5 = > Power Tubes for Channel A
V6 = >

V7 - A = > Phase Inverter for Channel A
V7 - B = >

DIMENSIONS & SPECIFICATIONS

WEIGHT: shipping weight 20 lbs.

HEIGHT: 1 rack unit - 1 3/4 nches

DEPTH: 13 inches (over all - including knobs)

INPUT IMPEDANCE:

POWER REQUIREMENTS: (from AC mains) 117 volts

20/20

Personnal Settings Page

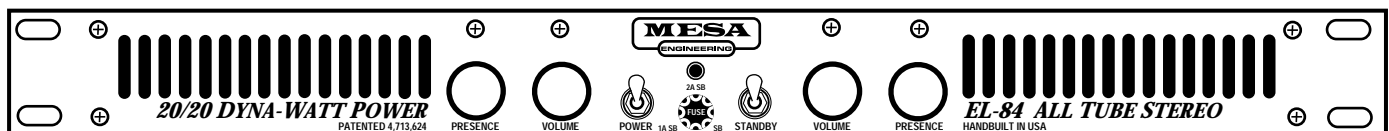
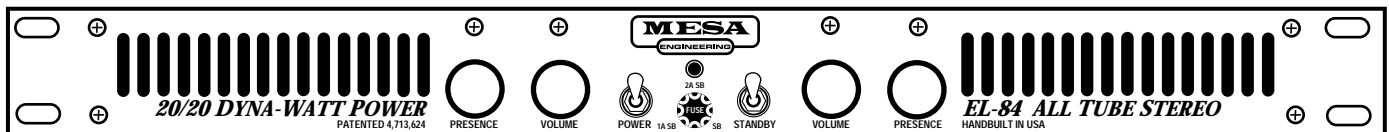
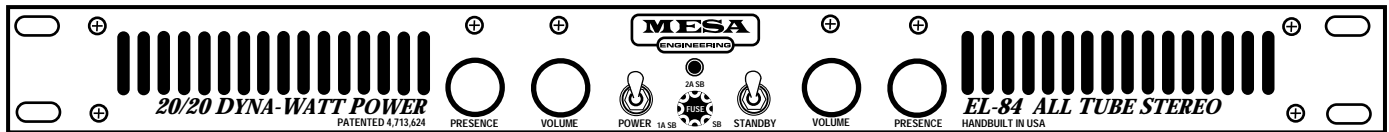
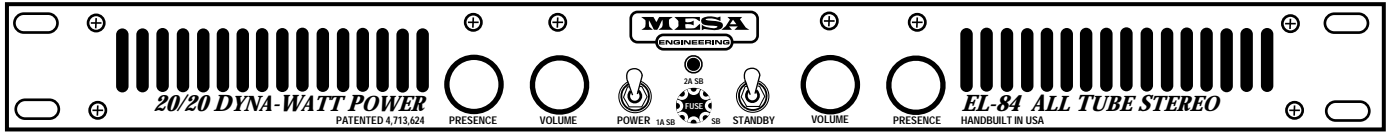

Parts Sheet - *20 / 20* - Front Panel

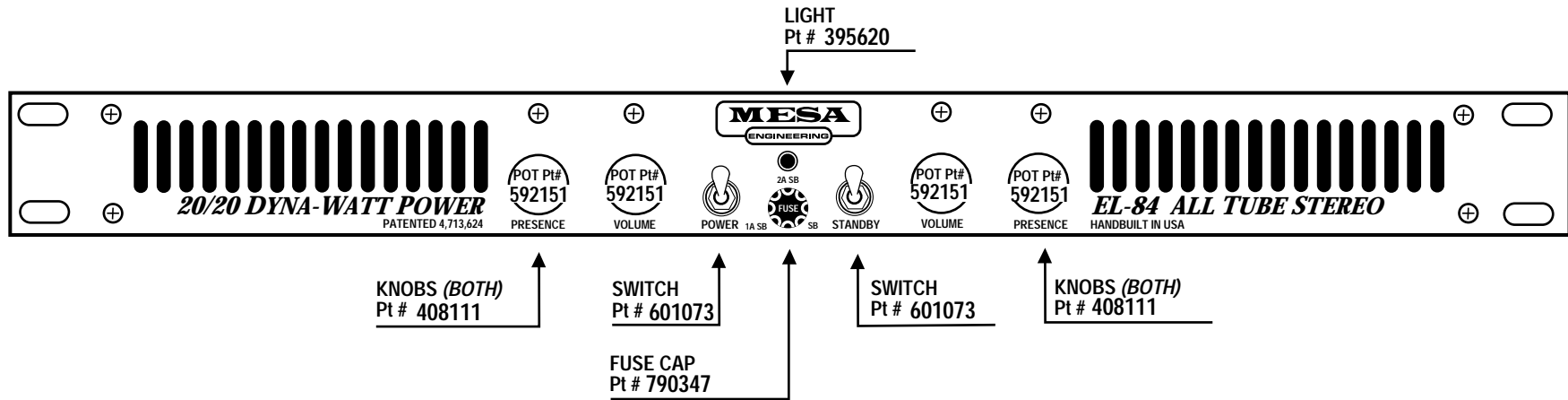

Parts Sheet - *20 / 20* - Rear Panel

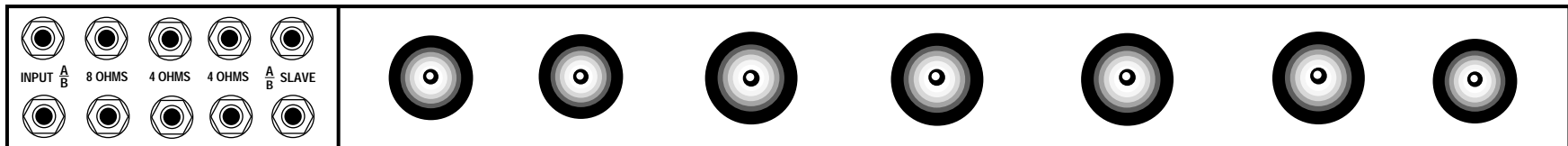

ALL JACKS
Pt# 613111

MESA/BOOGIE

The Spirit of Art in Technology

Thank you for trusting MESA/Boogie to be your amplifier company. We wish you many years of toneful enjoyment from this handbuilt all tube instrument.

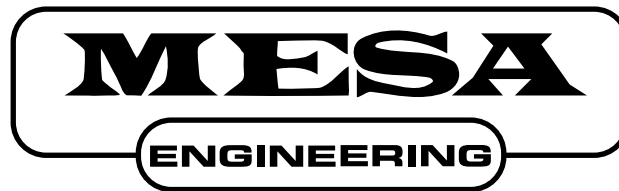

The Spirit of Art in Technology



1317 Ross Street Petaluma, CA 94954

USA

Phone No. 707-778-6565 FAX No. 707-765-1503