

***MESA/BOOGIE***<sup>®</sup>

  
**NOMAD**<sup>™</sup>

ONE-HUNDRED

)

FIFTY-FIVE

)

FORTY-FIVE

***Owner's Manual***

***The Spirit of Art in Technology***



***1317 Ross Street Petaluma, CA 94954***

***USA***

***Greetings from the Home of Tone  
and Welcome to the Mesa/Boogie Family!***

*We would like to congratulate you on the purchase of your new Nomad Amplifier. If you have not yet realized the power and versatility of this instrument, we hope this manual will provide an enjoyable tour through the many stylistic regions this exciting platform was born to roam. Hopefully after getting to know the channels and their modes and how best to apply them to your music, the Nomad will lead you to the yet unexplored regions of your own creativity and leave you with the map to return confidently time and again.*

*Inspired by the ancient peoples who left the security and comfort of their villages and set out in search of answers and a deeper meaning to life, these amplifiers are vehicles of exploration. So it is in tribute to these timeless bands of spiritual wanderers...we have named these amps Nomads. And like those for which they are named, you will find them at home in any musical land.*

***Your Mesa/Boogie Amplifier is a professional instrument. Please treat it with respect and operate it properly.***

**USE COMMON SENSE AND ALWAYS OBSERVE THESE PRECAUTIONS:**

- Do not expose amplifier to moisture, rain or water, direct sunlight or extremely high temperatures.
- Always insure that amplifier is properly grounded.
- Always unplug AC power cord before changing fuse or any tubes.
- When replacing fuse, use only same type and rating.
- Avoid direct contact with heated tubes.
- Insure adequate air circulation behind amplifier.
- Keep amplifier away from children.
- Be sure to connect to an AC power supply that meets the power supply specifications listed on the rear of the unit.
- If there is any danger of lightning occurring nearby, remove the power plug from the wall socket in advance.
- To avoid damaging your speakers and other playback equipment, turn off the power of all related equipment before making the connections.
- Do not use excessive force in handling control buttons, switches and controls.
- Remove the power plug from the AC mains socket if the unit is to be stored for an extended period of time.
- Do not use solvents such as benzene or paint thinner to clean the unit. Wipe off the exterior with soft cloth.
- Be sure to have the warranty card filled out by the store at which it was purchased and return to Mesa/Boogie.

**YOUR AMPLIFIER IS LOUD! EXPOSURE TO HIGH SOUND VOLUMES MAY CAUSE PERMANENT HEARING DAMAGE!**

**No user serviceable parts inside.** Refer service to qualified personnel. Always unplug AC power before removing chassis.

**EXPORT MODELS:** Always insure that unit is wired for proper voltage. Make certain grounding conforms with local standards.

**READ AND FOLLOW INSTRUCTIONS OF PROPER USAGE.**



## Table of Contents

### Precautions

Overview & Instant Gratification _____	1 - 4
Tips for the Desert _____	4 - 5

### FRONT PANEL CONTROLS & SWITCHES

Gain, Master and Presence _____	5 - 7
Treble, Middle and Bass _____	7 - 9

### CHANNEL MODES:

Channel 1 - NORMAL & PUSHED _____	9 - 10
Channel 2 - NORMAL & MODERN _____	10
Channel 3 - NORMAL & VINTAGE _____	10
Graphic EQ & Sample Settings ( Nomad 100 Only ) _____	11
Output & Solo Level Controls _____	12
Toggle Switches - HI VOLTS and AC MAINS _____	12 - 13

### REAR PANEL CONTROL, SWITCHES & JACKS

Footswitch Connect, Fuse & Rotary Channel Select _____	14
Recording Out, Speaker On / Speaker Mute and Bias Switch _____	15
FX Mix - Send & Return _____	16
Power Amp Voicing - Nomad 45 Only & 50 / 100 Watt Switch Nomad 100 Only _____	17
Reverb _____	17
Speakers _____	17
Slave _____	18
Sample Settings _____	19 - 25
Tube Description & Task Charts _____	26 - 28
Tube Noise & Microphonics _____	29
Diagnosing Pre-Amp Tube Problems _____	30
Bias Adjustment: a feature article by Randall Smith _____	31 - 33
Speaker Impedance & Possible Hook-Up Schemes - Amplifier to Speaker Cabs _____	34 - 39
Triodes, Pentodes & Irishmen: a feature article on the workings of tubes _____	40 - 42
Parts Sheets _____	43 - 45

# NOMAD

ALL TUBE AMPLIFIER

## Overview:

Nomad amplifiers are available in many configurations in terms of power / speaker combinations, as well as "head only" formats. All Nomad amplifiers share basically the same pre-amp and since most Mesa/Boogies are available in many choices as to power and speakers, for all practical purposes, Nomad refers to this pre-amp.

**Pre-Amp:** The Nomad pre-amp is comprised of three discreet Channels which may be footswitched between. Each of these channels offers two manually selectable Modes of operation. In basic terms, each of these modes offer a choice between a lower gain, slightly tamer voice and a wilder, gainier personality. This is an extreme simplification of their individual character however, as they all move easily across a wide range of sounds, prompting us not to limit them with the usual Rhythm and Lead nomenclature. Thus you will find them named and referred to as Channels 1, 2 and 3.

## NOMAD Showing all 3 Channels

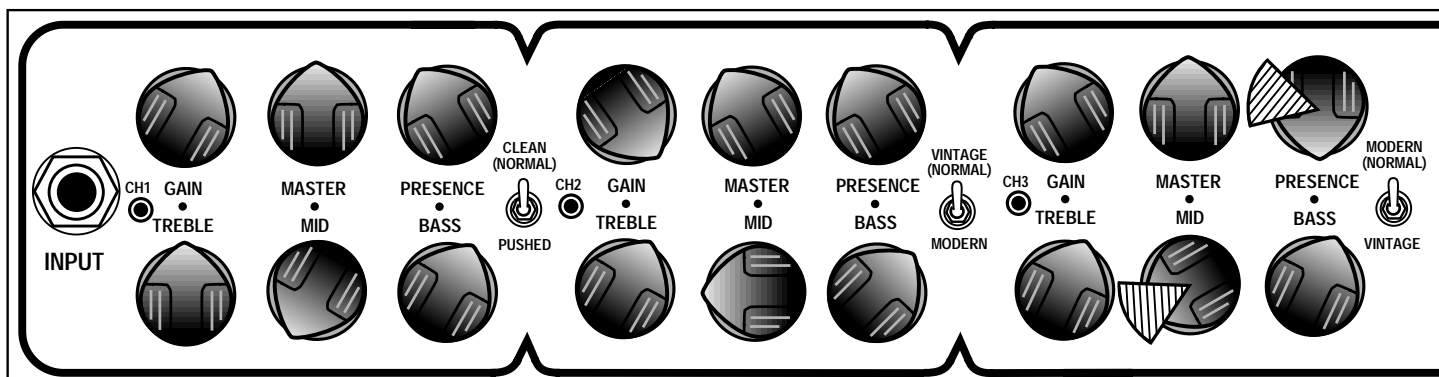

The Modes have been named in each Channel for ease of comprehension and identification - especially for the first time pilot - with their most common application labeled "Normal". (Found with the mini-toggle in the "up" position.) When all three channels are "normalised" the player is presented with one low-gain clean (Channel 1), one medium-gain, turbo vintage (Channel 2) and one high-gain modern channel (Channel 3). In this way a great slice of the amplifiers many flavors can be sampled quickly and instantly from the Footcontroller.

For the more adventurous, the Channels may be switched out of their NORMAL Modes and three entirely new channels may be explored.

## NOMAD Showing all 3 Channels (partial views)

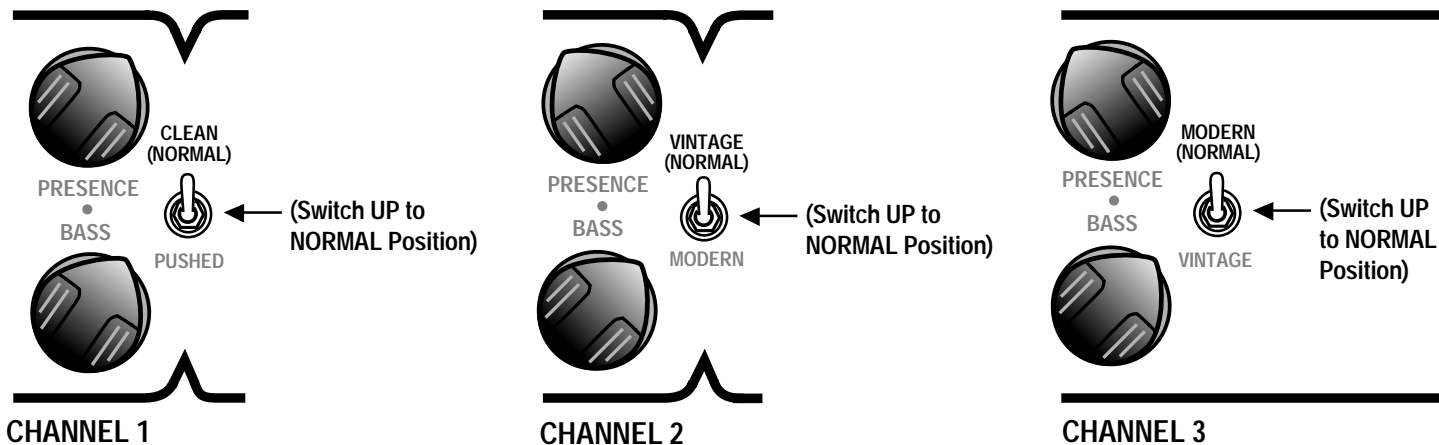



## Overview: (Continued)

**The NOMAD 55:** represents the deal of the century with its robust 55 watts produced by two 6L6 pentodes. With ample headroom for clean styles and a slightly brighter, more aggressive nature than its bigger brother the Nomad 100, the 55 lives in the region many players consider the perfect wattage arena. This Nomad is also available in two chassis sizes so it can be configured to taste and need. A widebody 1x12 combo optimizes the characteristics of a wider cabinet and a rear mounted speaker to produce a bigger, breathier sound that is more vintage in nature. This chassis size also produces a great "head only" package. The 55 is also available as a mid-weight 2x12 or 4x10 combo with a wide head also possible in this chassis size.

## FRONT PANEL Nomad 55

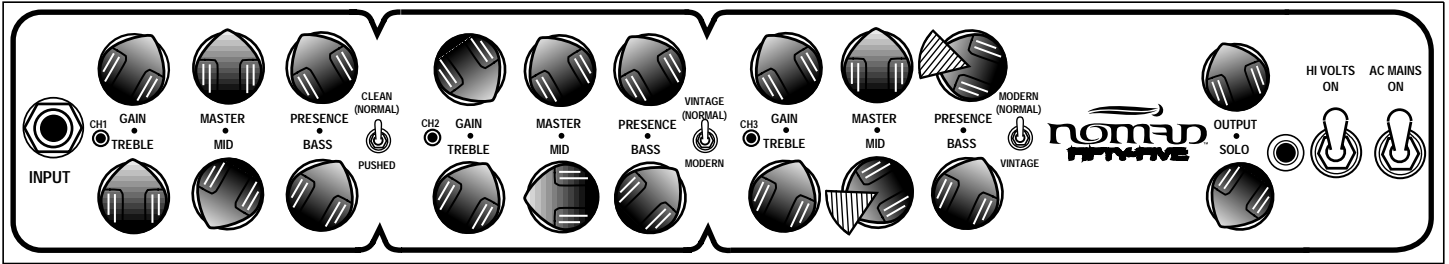

## REAR PANEL Nomad 55

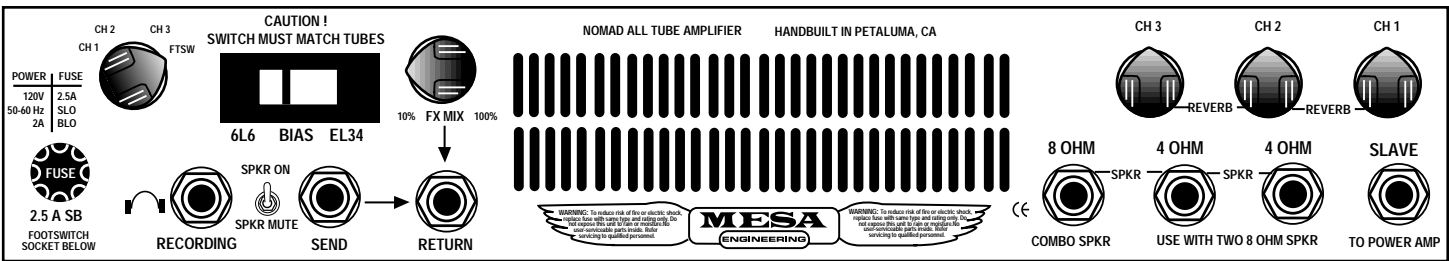

**The NOMAD 100:** is no doubt the ruling sultan of this band. With headroom for any situation and a richness of character that is only found in 100 watt power sections, it is the obvious choice for those who find themselves in larger venues. An added bonus comes with the Nomad 100 as well with the fitting of the on-board 5 band Graphic Equalizer. A long time Mesa/Boogie tradition, this powerful shaping tool can either be footswitched in and out at will to enhance specific sounds - or engaged as a global shaping device to accommodate certain rooms or playing situations.

The 100's sturdy 4x6L6 harness is found on two different chassis sizes as well, and the choices are the same as that of the Nomad 55. A widebody Nomad 100 1x12 combo or head, as well as 2x12 and 4x10 combos and a wide head for use with any of our closed or open back 4x12 cabinets producing a sound that is...yes, huge!

## FRONT PANEL Nomad 100

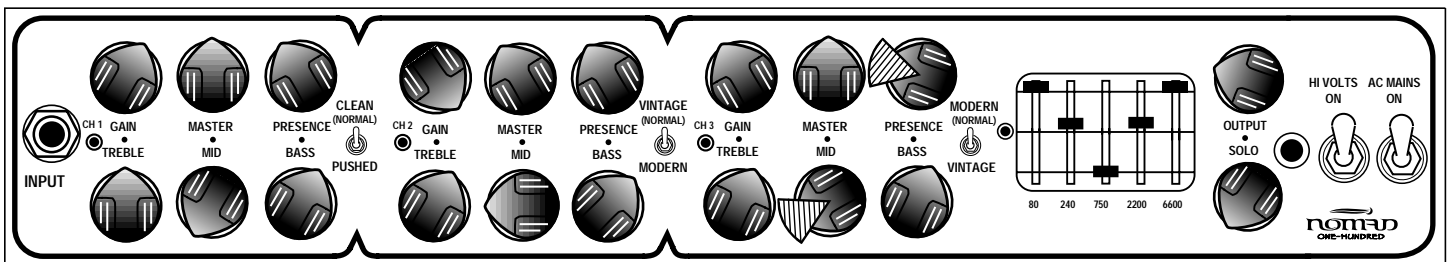

## Overview: (Continued)

### REAR VIEW Nomad 100

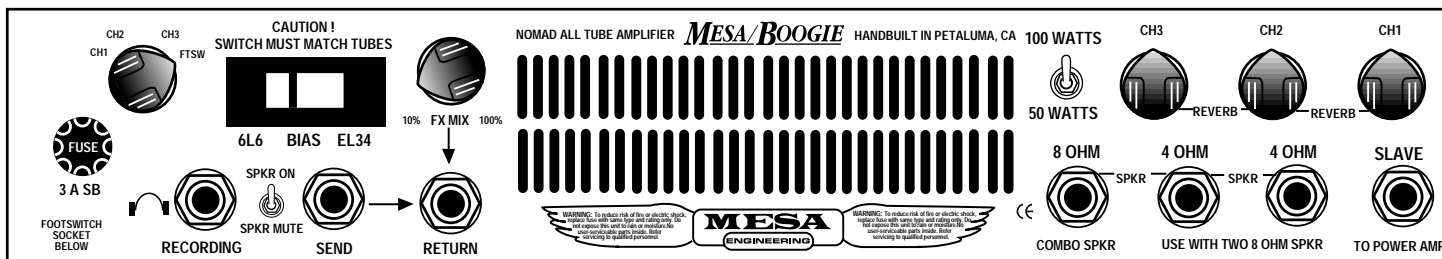

No matter which of these many Nomad platforms you have chosen, the basic operation is the same and the experience playing them is oo...fun and exhilarating. Before we get to specific Controls and Channels, here are some tips to get you playing and enjoying your Nomad right away;

### Tips for the Desert:

- (1.) The REVERB Controls for all three Channels are located on the Rear Panel.
- (2.) The Footcontroller connects to the chassis on the far left underside of the Rear Panel.
- (3.) The Rear Panel Channel Select Rotary Must be set to Footswitch in order for the Footcontroller to call up the Channels and Functions. The SOLO Control has no Effect on the signal until the Footcontroller is connected and Footswitch is selected on the Channel Select Rotary.
- (4.) The SOLO Control increases the volume from where the OUTPUT Control has been set.
- (5.) The GAIN and TREBLE Controls are the most powerful controls in all the Channels. Use them with taste and remember that some of the best sounds are found by using these two controls in their middle regions.
- (6.) Extreme Volume Level Increases Occur when Ch. 1 & Ch. 2 mode switches are switched down to their alternate modes from NORMAL to PUSHED and MODERN. Reduce Channel MASTER or OUTPUT Controls before selecting these modes !
- (7.) Volume Level will drop when Ch.3 mode switch is switched down from NORMAL to the alternate VINTAGE mode. Compensate with either Channel MASTER or OUTPUT Control.
- (8.) When using the Effects Loop for external signal processing, the best tonal results will be obtained with the processors' dry / wet mix set to 100% and the FX Mix set as close to 10% as possible.

Hopefully these tips have saved you from any frustration and now that you've got everything connected, we have provided a few sample settings that you might want to try in each channel, to more quickly familiarize you with the Nomad's sonic possibilities.

These sounds and settings are by no means the only ones possible and as always, we encourage exploration and experimentation.

## Tips for the Desert: *(Continued)*

### Quick Demo Settings:

#### Channel 1 NORMAL Clean

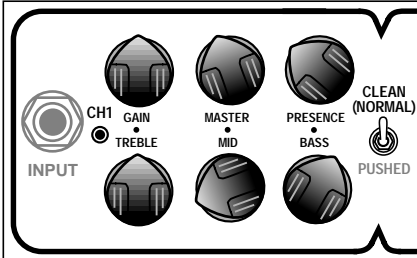

#### Channel 1 PUSHED Crunch

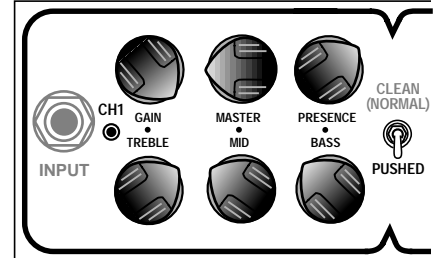

#### Channel 2 VINTAGE Purring Blues

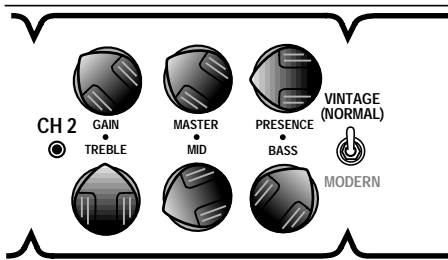

#### Channel 2 MODERN Liquid Grind

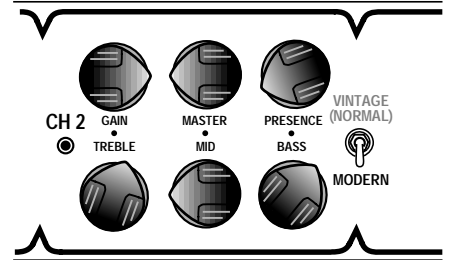

#### Channel 3 MODERN Spank Blues

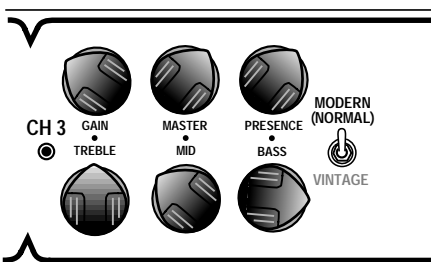

#### Channel 3 VINTAGE Violin Gain

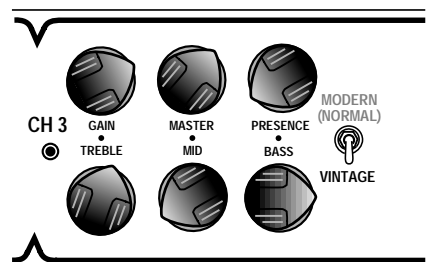

### The Controls:

Before we get to each individual control and how they interact with each other, there is one thing they all have in common. They all have "sweet spots". These regions move around the clock face in accordance with several factors such as the style of sound you are dialing for, pick-up height, pick-up strength, your individual picking technique and the type of speaker and cabinet your Nomad is driving.

To attain the best tone and performance from your amplifier, we recommend that you spend time learning the sweet spots of each control and how they affect the function of the other controls. This way you will be able to dial virtually any sound you wish in any channel quickly and accurately.

## The Controls: (Continued)

**GAIN :** This control adjusts the predominant gain stage in each channels' circuit with the function and taper being optimized for each individual channel. Remember that your Nomad is really three separate dual mode amplifiers built onto one chassis, so though each channel looks identical, the GAIN Control for each channel comes in a different place and adjusts a different point in that channels circuit.

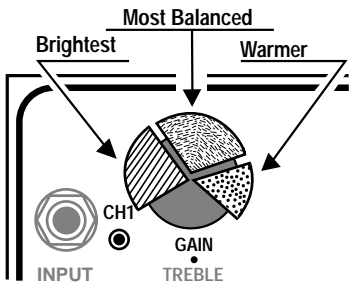

In most guitar amplifiers, and especially in all-tube circuits, the GAIN Control is the most powerful control in the preamp. It shapes the overall style and character of the sound and is responsible for whether the sound is clean, overdriven or anywhere in between. In your Nomad, the GAIN Control is even more powerful. It not only determines the amount of drive, but also acts as an integral part of the tone control string as well.

To simplify the GAIN Controls' role in shaping the overall tone of the sound we will look at it in two ways - 1; alone and 2; in conjunction with the tone controls.

1) By itself the GAIN Control has basically three tonal regions -

Low ( 7:00 - 11:00 ) provides the cleanest, least saturated sounds and in this region the sound will be brighter and contain more upper harmonics lending a three dimensional character to the sound.

Middle ( 11:15 - 2:00 ) enhances the saturation and replaces some of the upper harmonics with a richer, warmer quality and a fuller bottom end response. Not yet fully saturated, this region is the easiest place to get a great sound in all three channels. This region contains many of the Nomads' best sounds...especially for soloing due to the crucial blend of an expressive attack combined with ample sustain.

High ( 2:15 - 5:00 ) saturates the signal and enhances low and low mid frequencies. While this region provides the maximum saturation and therefor sustain, it also compresses and softens the attack characteristics. For this reason we suggest using this higher region of the GAIN Control sparingly and only when maximum sustain is needed.

NOTE: Due to the Nomads' extreme gain potential, the highest regions of the GAIN Control may possibly push the pre-amp tubes past what they can handle, producing microphonic squealing. While we screen and test the tubes your amplifier was shipped with and the tubes in your amp passed our rigorous test, we can't predict how the tubes will respond over time exposed to extreme gain settings. Your tubes are warranted for a period of 6 months under normal use, but you can save yourself the present and future inconvenience of having to deal with annoying microphonic tube problems by simply using a little common sense...Don't turn the Gain all the way up!

If you must for a specific part or at very low volumes, back down the TREBLE and PRESENCE Controls. Your Nomad was designed to provide amazing gain and tone at less than extreme settings removing the need for you to crank everything all the way up. If you are not able to achieve the sound you want at sensible settings on any or all of the controls, your problem may lie elsewhere in the signal chain, i.e. pick-ups, cabinetry, processing etc. Keep in mind you can always call on one of our product specialist Monday through Thursday and seek some advice should you find yourself struggling to get the sound you want.

2.) GAIN - In conjunction with the Tone Controls -

Basically, a simple rule applies...as the Gain is increased the Tone control string has less and less effect on the signal until at 5:00 the signal is so saturated that you are getting mostly Gain and very little Tone. Again, this is the reason we suggest using the GAIN Control in its middle region. Here the Tone control string is very active and provides maximum shaping power - allowing you to dial virtually any sound you desire.

## The Controls: (Continued)

**MASTER :** This control is the master feed from the end of the pre-amp to the driver stage and the Effects Loop. As you can see each Channel is fitted with its own MASTER Control, enabling the three channels relative volumes to be matched regardless of their extremely different sound styles and gain signatures. The MASTER Control makes possible a wide range of sounds through its ability to use very low Gain sounds at high volumes and conversly, high Gain sounds at low volumes and everywhere between.

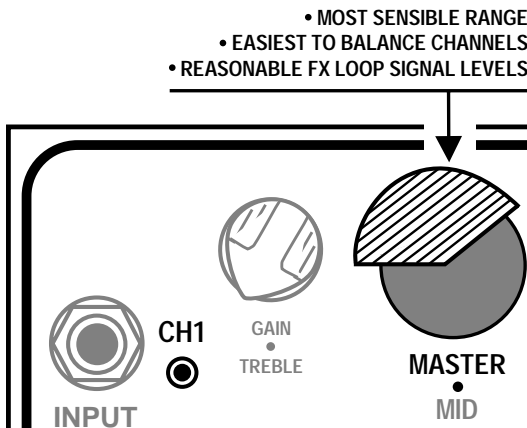

Again, we suggest using the MASTER Control in its sensible ranges ( 9:00 - 2:00 ). Here, the channels will be easier to match with each other and the Effects Loop will see more reasonable signal levels.

NOTE: Because the MASTER Control creates the send to the Effects Loop, extreme settings will cause a large signal to be sent to the Loop for that Channel. Not only may this cause possible overloading of the processors Input stage, but will make balancing the three channels' Effect Send level difficult.

**PRESENCE :** This control regulates the amount of negative feedback in the power amp stage and affects mostly higher frequencies. It acts independantly of the other rotary tone controls and is crucial in voicing the Channel. It is a powerful global tone control.

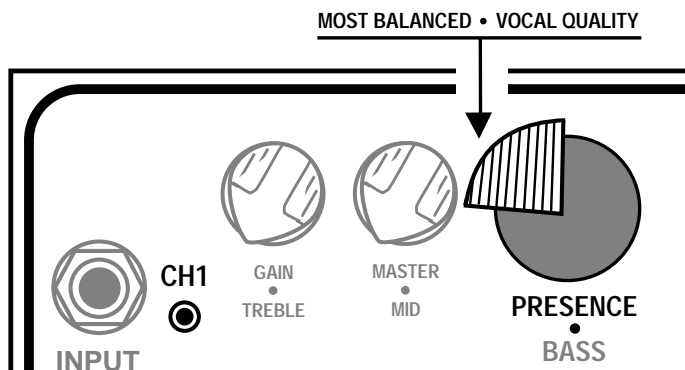

Lower PRESENCE Control settings darken and, in fact compress the signal which works well to fatten single note solo sounds, giving them girth and focus. Some of the best lead sounds in your Nomad will find the PRESENCE Control in its lower regions, where a balanced, vocal response is achieved.

**TREBLE :** As in most tube guitar amplifiers, the TREBLE Control ( in all three channels of your Nomad ) is the most powerful of the rotary controls and is next in line only to the GAIN Control as a shaping tool. Because it is first in the signal path of the tone controls - and from here the Middle and Bass receive their signal - it is by far the dominant tone control. For this reason the setting of the TREBLE Control is very important for equal representation of the three frequency regions to appear at their respective controls. Like most of the controls on your Nomad, there is an optimum region of the TREBLE Control where ample top end is mixed in and yet enough signal is still passed on to the MIDDLE and BASS Controls.

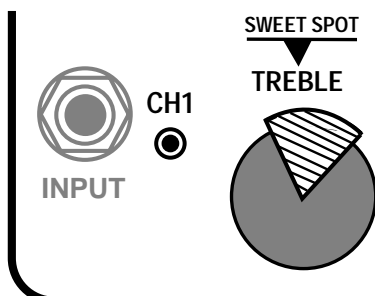

As you might surmise, here is the sweet spot. There are definitely great sounds above and below this middle region ( 11:00 - 1:30 ), but the balance between the TREBLE Control and the other two tone controls is compromised.

## The Controls: (Continued)

**TREBLE :** (Continued) The one place you may want to throw caution to the wind and set the TREBLE Control above this median zone presents itself in Channel 1. In both modes ( Clean & Pushed ) the TREBLE Control can be used to dump extra gain into the mix. This is especially effective in the PUSHED mode for crunch sounds. When doing so use the PRESENCE Control to roll off some of the more than ample top end for a more compressed feel and fatter voice. As you might surmise, the BASS Controls' effectiveness will be reduced, so you may have to run a much higher setting than you are used to seeing to achieve a balance.

**MID :** The MIDDLE Control is responsible for the blend of midrange frequencies in the mix and though its effect is not as dramatic as that of the TREBLE Control, it plays an integral part in achieving any sound in your Nomad. It is capable of changing the feel dramatically as it blends in a group of frequencies that tend to soften or stiffen the way a sound feels to play.

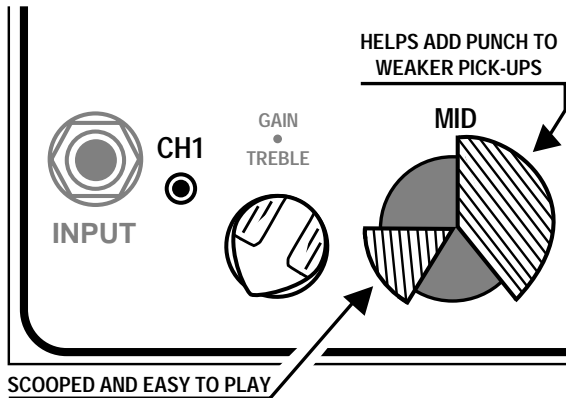

Most players tend to lean in the direction of lower MIDDLE Control settings ( 7:00 - 11:00 ) where a scoop in this region produces girth ( by letting the Bass become a little more dominant ) and a lack of punch lends a more compressed, even feel to the strings and therefore less apparent resistance to the pick. As the MIDDLE Control is increased, ( 11:30 - 1:30 ) the sound is rounded-out and filled-in with a focused mid attack appearing rather quickly. As you would guess, the feel starts to change - becoming more resistant. Above this region the MIDDLE Control could be used to compensate for either weaker pick-ups or for times when a specific deficiency is produced by either an extremely high setting

of other tone controls, or a physical anomaly in the room. While these MIDDLE Control settings ( 2:00 - 5:00 ) can introduce added gain and create enhanced focus, the trade-off will be a stiffer, more forward, less compressed feel.

Channel 1 utilizes a different MIDDLE Control than that of the Channels 2 and 3 with a custom-designed taper and value. In its low range ( below 12:00 ) it functions as a normal midrange control with a taper suited to blending fine increments of these frequencies. Most players lean toward a fairly radical scoop ( 7:00 - 10:30 ) for clean playing, preferring to let Treble and Bass remain dominant, thus producing the signature sparkle and breath essential for a pristine clean sound.

As Channel 1's MIDDLE Control is swept past 1:00, it quickly starts to add gain in these midrange frequencies adding cut and punch. As the top end of the control is reached, ( 3:00 - 5:00 ) it becomes an additional gain control capable of taking both CLEAN and PUSHED modes to extremes. Experiment with this cranked region in conjunction with extreme settings of the other tone controls to balance both sound and feel. While this added flexibility may make Channel 1's MIDDLE Control a little more tricky to learn at first, it will become quite valuable as you start to realize the power of this super versatile channel.

**BASS :** Last, but definitely not least in the string of tone controls we, come to the BASS Control. This control works similarly in all three channels in that it determines the amount of low frequencies present in a sound. However, the actual frequencies and style of lows it mixes in changes from channel to channel. Like the MIDDLE Control, it falls in line signal-wise after the TREBLE Control and the same scheme

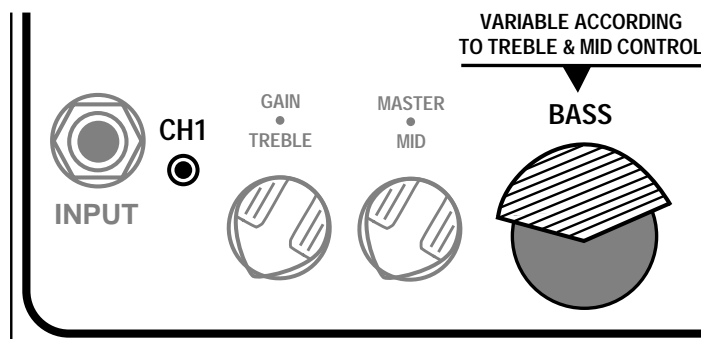

applies. When the TREBLE Control is set high the effectiveness of the BASS and MIDDLE Controls is reduced. If the TREBLE Control is set low these two controls become dominant.

For the most balanced sound and a balance of power between the three rotary tone controls, try to use the TREBLE Control in its middle ranges. This scenario produces nearly equal representation of all the frequencies on the tone controls and provides a great neutral starting point for further tweaking.

## The Controls: (Continued)

**BASS: (Continued)** The Bass frequencies are, as we mentioned, different in each channel and appear as follows:

**CHANNEL 1:** Enhanced low and sub-low regions provide warmth and most importantly, breath for clean sounds which produces a bouncy, elastic feel and natural sounding fundamental, yet with plenty of air.

**CHANNEL 2:** Sub-low extension defines this channels bottom end character and produces the deepest sounds in your Nomad. This is the fattest channel for single note work and chording will sound huge...especially when higher GAIN Control settings are applied. If you are not careful with the BASS Control in this channel - it may spoil you and leave you with a good case of EQ overhang...leaving the other channels sounding almost "thin" by comparison.

Also, don't be surprised if at first, Channel 2 feels slower and a bit harder to steer. It can take a while for your picking technique to adjust to pushing around a sound of this girth. You will adjust and quickly find that these extra-low lows make for some unbelievable solo sounds.

**CHANNEL 3:** In this channel the opposite approach is taken and the emphasis is not on how low can you go, but rather how tight can you get. By raising the low frequencies and focusing on how well they track - and stop after the note sounds, a totally different personality emerges. This tracking characteristic adds bounce to both chording and single note styles and is essential for urgent high gain rock sounds. Due to its higher, tighter nature this BASS Control may be set higher than that of the other two channels without the feel of becoming slow or clumsy. In fact, this is the one control you can even run all the way up without worry.

**NOTE:** Do Not run the Bass all the way up in any channel when using the direct Recording Output ! Damage to the playback monitors could occur. When using the direct Recording Output, start with the Bass set relatively low and set conservative ( safe ) input levels at the console first. When levels are satisfactory you may then increase the BASS Control slowly and adjust levels as you go in order to prevent damage to playback monitors.

## Channel Modes:

As mentioned earlier, each of the Nomads' three channels contain two different modes so that each channel may be configured for an array of different sound styles. These opposing modes are selected by the mini-toggle switch located inside each channels borders. The upper position of the toggle in each channel is labeled "NORMAL" and calls up the "primary" sound for that channel. This scheme allows for quick demo tours through the three channels and provides the fastest understanding of the footswitchable possibilities with quickly identifiable sounds. Once this configuration has been auditioned and the channels explored, the modes can be drastically modified by a simple flick of the switch. As you will hear, these switches alter the voice of each channel radically as several different internal changes occur per channel. How you choose to utilize these alternate sounds is up to you and experimentation can lead to some of the most versatile footswitching you could find in any amplifier.

### Channel 1 NORMAL / PUSHED

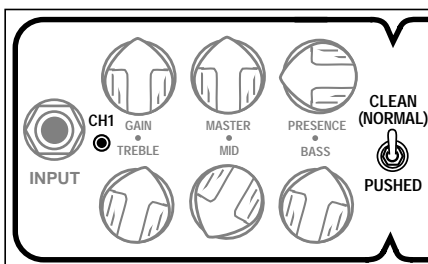

**CLEAN / NORMAL:** This is the lowest gain circuit of the Nomads six modes and is optimized for producing balanced pristine clean sounds. For the best understanding of how to achieve a great sound in this mode, please refer back to the GAIN Control section of this manual. However, a great place to start is 12:30 or so on the GAIN Control with more sparkle available below this and more warmth apparent above...from there adjust according to your guitars individual response.

Because of its more traditional architecture this mode also works extremely well for vintage style drive sounds. By turning the gain all the way up, a beautiful old school solo sound is possible...especially with neck single coil pick-ups. The TREBLE and MIDDLE Controls can also add gain and sustain to this sound ( reduce Presence to blend highs ), but you will probably want to run the BASS Control below 10:30 to avoid flubbiness and preserve a focused attack.

## Channel Modes: (Continued)

**PUSHED:** This mode is a radical departure from the sweet shimmering blend of the CLEAN / NORMAL modes low gain character. Huge increases in gain early on in the first stages of the pre-amp produce one of the biggest differences between modes in the entire amplifier and transforms what you thought to be a tame and gentle clean channel into a raging crunch machine. This incredible amount of gain also creates one of the most expressive solo modes in your Nomad. Because there are less stages of gain for the signal to travel through and the tone control network is tuned for the brighter nature of clean sounds, this mode responds quicker to your pick attack and has a more urgent, snappy feel. Don't overlook this mode for some of the Nomads' best overdrive solo sounds.

### Channel 2 NORMAL / MODERN

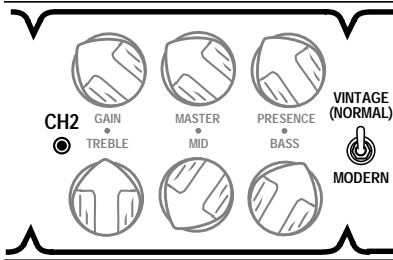

**VINTAGE / NORMAL:** The first of Nomads' high gain lead channels was endowed with an orange LED indicator not by accident. The warm glow reminded us of smoldering embers...a fire burning warm with all the comforts of home. Upon first playing Channel 2's VINTAGE/NORMAL mode most players stop - grin - and say one word...FAT. This mode has been optimized to round out single notes and enrich their character with creamy, warm drive. You will quickly discover that this mode has no optimum setting as it presents the entire range of the control with amazing balanced lead sounds. Set low ( Gain at 9:30 and below ), it doubles as a low gain chording or blues sound that purrs with vintage authenticity. From there on up to 3:00, many different styles of solo sounds are available that work great with either single coil or humbucking pick-ups and no matter how you serve it up it's always gonna be big... huge !

**MODERN:** This mode had its early beginnings in an idea that sprang to life in the late eighties and found its way on to our Dual Rectifier Solo Head called Channel Cloning. Well, as usual we ended up going far beyond the original idea and now this mode is simply a more aggressive, over the top, hardcore version of the already monstrous Channel 2 NORMAL mode. This sound is the hugest rock sound in the Nomad and for all out girth, it tips the scales. The same stylistic ranges apply as those of the NORMAL mode, but the top end of the GAIN Control unleashes the true beast within, and should be experienced with a hot humbucking pick-up to really appreciate its footprint.

**NOTE:** Reduce the MASTER Control when switching from VINTAGE NORMAL to MODERN as internal changes in the circuit increase volume levels dramatically !

### Channel 3 MODERN / VINTAGE

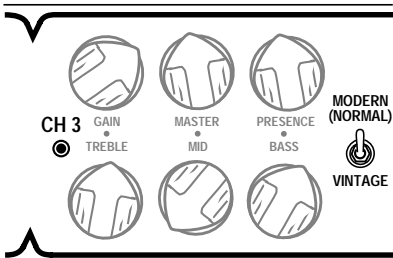

**MODERN / NORMAL:** This mode is the hyper stallion in the Nomad camp. An enhanced attack region and a brighter overall response combined with a slightly higher low end curve give Channel 3's NORMAL mode the edge when it comes to speed and agility. The nature of this mode is the polar opposite of Channel 2's languid, slowhand purr.

It bounces to life with the slightest of glances from the pick and can stop on a dime whether maxed out or running stripped. Again, like Channel 2's NORMAL, this mode handles low gain single coil styles and high gain humbuck sounds with equal attitude... and we do mean attitude!

**VINTAGE:** This "slightly" detuned, warmer rendition of Channel 3's NORMAL mode makes it possible to use Channel 3 for some of the sounds you might like in Channel 2 and though the Bass frequencies are a little higher, they are just as amazing. By offering a way for each channel to lean toward the other, many possible configurations appear and the footswitching applications are expanded greatly.

You might wish to use Channel 2 NORMAL for a semi-clean rhythm mode and Channel 3 VINTAGE for a blues style solo sound. Conversely, you might need Channel 3 NORMAL to cover your high gain ( maybe Channel 1 PUSHED for lower gain ? ) crunch rhythm stuff - and Channel 2 MODERN for a crazy, blistering solo sound. There are a myriad of ways to configure the Channels 2 & 3 and so many great combinations of mode swapping that will make your footswitching allocations less confining, freeing you up to play your best.

**5 BAND GRAPHIC EQUALIZER : (Nomad 100 Only)**

If you have purchased the Nomad 100 you have probably already realized that the bonus gift of the On-Board 5 Band Graphic Equalizer is well worth the omission of the beautiful, but stoic, Nomad logo. This long time Boogie tradition is a powerful shaping tool and when added to the already fully evolved Channels of the Nomad, any sound you can dream of is at your fingertips. It may be assigned to the signal path globally or footswitched In and Out at will.

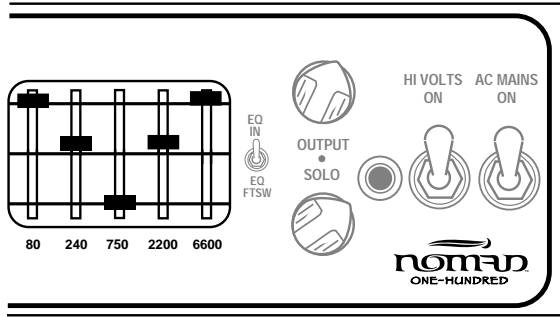

The five wide-band sliders offer the full spectrum of frequencies in a guitar-friendly format that is infinitely easier and faster to use than either narrow-band graphic or parametric type equalizers. There is a more gentle blend between the regions and therefore less likelihood of holes in the tone and response, resulting in a musically smart system of shaping guitar sounds...especially overdrive sounds.

NOTE: When the EQ is switched out there will be a small amount ( 3% max. ) of its effect still on the signal. This small amount should cause no problem and is considered normal. This is essential to achieve seamless footswitch operation.

Here are a few examples of how we have seen players utilize this powerful shaping device, with the classic "V" curve and its amazing widening effect being the most popular for almost any style.

**1.** The fabled "V" shape ( Most Popular )

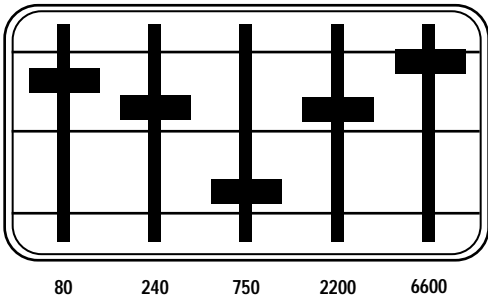

**2.**

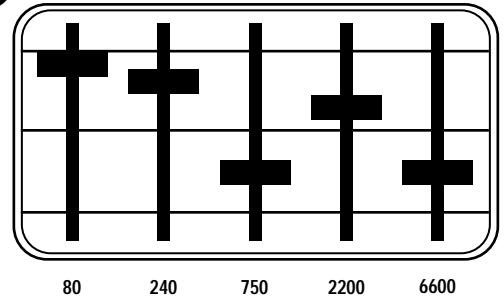

**3.**

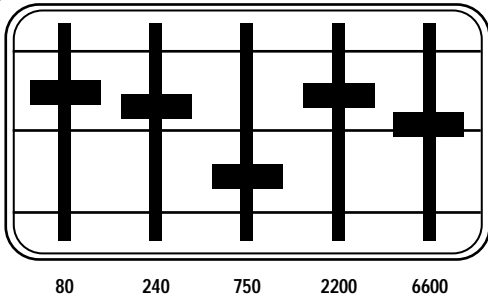

**4.**

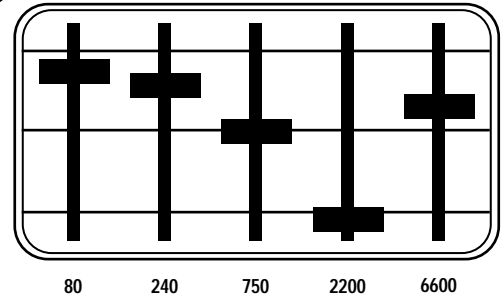

## FRONT PANEL CONTROLS: (Continued)

**OUTPUT CONTROL :** This control determines the overall output volume level of the amplifier. After the GAIN Controls have been set for the desired sound style and the three channels levels have been balanced with their respective channel MASTER Controls, the OUTPUT Control allows you to change the playing volume level of the entire amp by adjusting a single control. The OUTPUT Control is also wired as the Effects Loop Return Level Control. Should you ever use your Nomad as a power amp alone by inserting a signal into the RETURN jack, the OUTPUT Control will serve as the master level control.

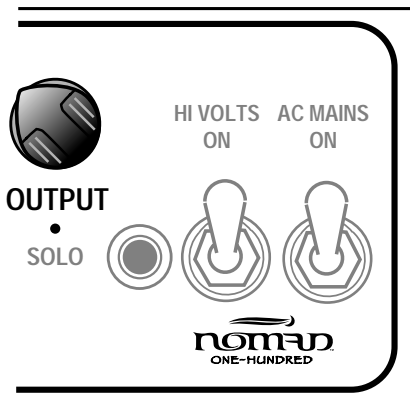

NOTE: When using the EFFECTS RETURN as an input - to use the Nomad as a power amp - the SOLO Control can be used to attain a footswitchable boost if the Footcontroller is connected. It is wired in parallel to the OUTPUT Control and therefore also controls the volume of the power section.

NOTE: The Effects Loop RETURN jack can serve as a power amp input so that you may use your Nomad as a power amplifier for either stereo reproduction or to incorporate additional pre-amps. While the possibilities for this type of application are virtually limitless, there are a

few things to remember that will help you when interfacing to the Nomad for use as a power amp only;

- 1.) Connect "Dummy" plug or loose cable to SEND jack. ( This prevents any possible loading that could result in diminished RETURN sensitivity.)
- 2.) The OUTPUT Level Control will be the only active control on the Front Panel.
- 3.) The SOLO Control may be used to footswitch in a pre-determined amount of boost when the footcontroller is connected.

**SOLO CONTROL :** This control can only be activated if the correct Footcontroller is connected to the Footswitch DIN jack. SOLO is an additional final output level control wired in parallel with the OUTPUT Control. It is capable of a setting above that of the OUTPUT Control and can not be set below. The amount of apparent boost also depends on that of the OUTPUT Control - in that if the amplifier is at either the extreme low or extreme high levels of the OUTPUT, its effectiveness is minimized. Its been optimized for live performance medium range volume levels.

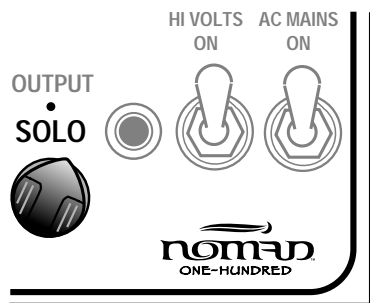

If the power section is either not a part of the sound (super quiet), or producing all its rated wattage ( super loud), there is very little signal for the SOLO Control to work with. By using the Footswitch and selecting SOLO, a pre-settable boost in overall level is possible on the fly...giving you some control over your levels when it's time to step out. Engineers may give you a bit of a frown the first time you use it...but isn't it time you heard yourself. It might even prevent them from punishing you with the dreaded monitor or sidefill version of your tone.

**HI VOLTS :** Perfect for set breaks... this toggle switch also serves an even more important purpose. When the toggle is in the down position the tubes are at idle so that during power up they may warm up before being put to use. Before A.C. Mains is switched on, make sure the switch labeled "HI VOLTS" is in the down position. Wait at least 30 seconds and then flip this switch to its ON position. This helps in preventing tube problems and increases their toneful life substantially.

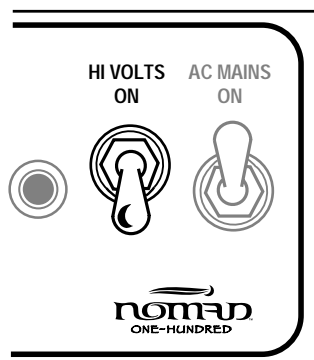

---

## FRONT PANEL CONTROLS: *(Continued)*

**AC MAINS :** This switch delivers the A.C. power to the Nomad. Make sure the unit is grounded (all three terminals of the A.C. power cord must be connected whenever possible to avoid injury to the user as well as to the unit) and that the proper voltage is present.

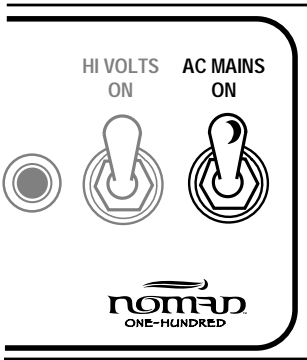

Follow the cold start procedure described in the previous section titled "HI VOLTS" when powering up your Nomad.

Well, now that you have an understanding of the controls and modes and how they interact with each other, its time to enjoy your Nomad with a good long exploration session. Ride that camel...and when your ready for a break we will spin 'round to the back side and take a look at the features residing aft. Meanwhile, enjoy and may the wind be at your back !

---

## REST AREA

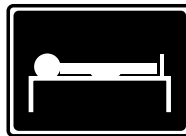
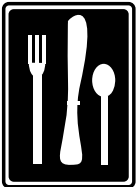

# REAR PANEL CONTROLS & CONNECTIONS:

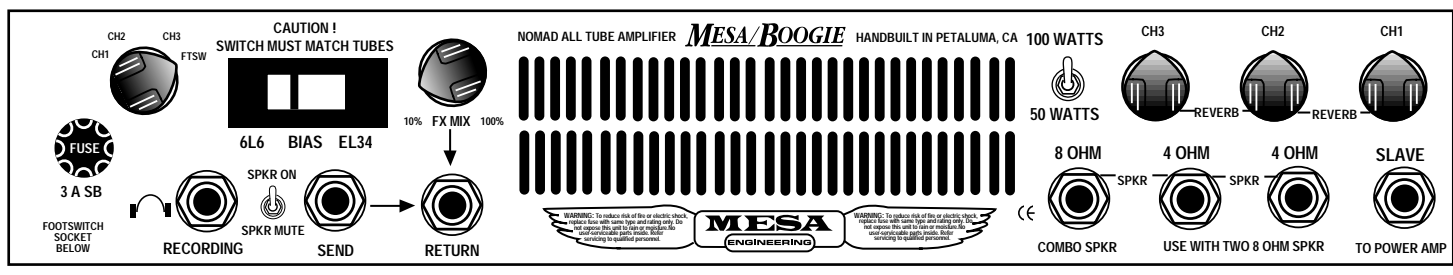

**FOOTSWITCH SOCKET :** This 7 Pin DIN type socket located on the underside of the chassis accepts the Nomad Footcontroller cable. To use the Footcontroller to select the channels and features;

- 1.) Connect the Footcontrollers' attached cable here by lining up the tab on the cable with the detent on the cable sleeve.
- 2.) Select "Footswitch" on the Channel Select Rotary control located above on the Rear Panel.
- 3.) Select the desired Channel or Feature.

**FUSE :** The Nomad 45 and 55 require a fuse with a rating of 2.5 amps - while the Nomad 100 utilizes a fuse with a 3 amp rating. All three models are fitted with Slo-Blo type fuses and should replacement be necessary in the future, replace the Fuse with the same type and rating. For export models please contact your dealer for specifics regarding your model of Nomads' power requirements.

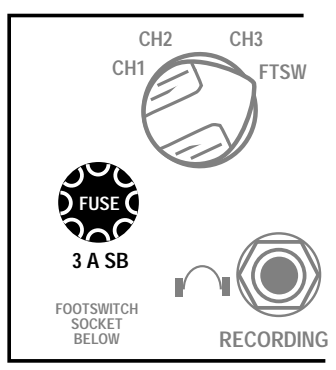

Definitely warm up the tubes first with the amplifier's HI VOLTS switch in its down position. Then carefully watch the tubes as you flip the HI VOLTS switch to its ON position - (switch up.) If you see a tube arc or spark inside, that is definitely the problem and can be remedied by an easy power tube replacement. In many cases though, the bad tube will only fail intermittently. Watch for a while and if any tubes start to run red-hot, this is the cause of your original problem. If everything appears OK, tap on each power tube to reveal the faulty one, because a blown Fuse is nearly always caused by a bad power tube (s). (See the section on tube maintenance further back in this manual for more assistance and helpful hints on how to maintain the life of the power tubes).

**ROTARY SELECT:** Use this Rotary Select switch when you happen to be without your Nomads' Footcontroller. Rotating this switch allows you to select a particular channel manually.

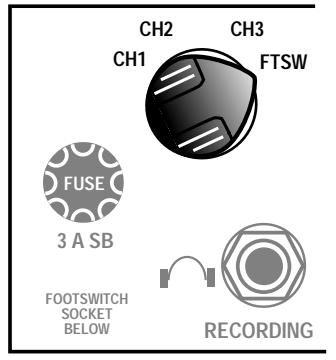

However, in order to use the Footswitch Controller this rotary must be set to the Footswitch position.

## REAR PANEL CONTROLS & CONNECTIONS: (Continued)

**RECORDING OUT :** This 1/4" jack captures the sound of your Nomads' pre-amp and shapes the sound, enabling direct insertion into a console for both recording and live reinforcement applications. It produces a mono signal and can send a level that should be adequate, if not optimum, for most mixing consoles. The level of each Channel is dependant on the Channels' MASTER Control. Less saturated sounds will produce greater dynamics and therefor a stronger signal at this Output with Channel 1 "Normal" producing the potentially hottest level. It is always good practice to start with the consoles' Input attenuator off and bring the level up slowly - to avoid damage to playback monitors in case you have inadvertently dialed up an extreme signal level.

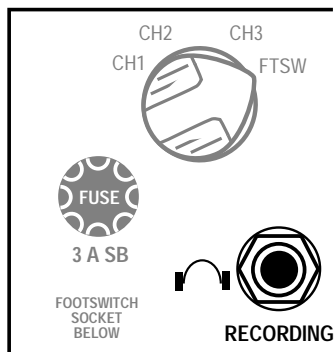

Brightness and upper harmonics may be adjusted by the PRESENCE Control to balance the three sounds and is especially important to great solo sounds in Channels 2 & 3.

Also, remember to use the BASS Control with care when using the Recording Output to interface to a console. Extreme settings can potentially cause damage to your playback monitors.

**SPKR ON / SPKR MUTE:** This two position mini-toggle mutes the signal at the driver stage to allow direct recording late at night or any time the sound of the speaker(s) is not appropriate. SPKR ON (up) allows the power section to receive signal and produce sound. SPKR MUTE (down) stops the signal at the driver stage - sending it to the RECORDING Output only.

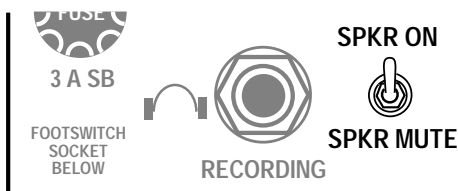

NOTE: For personal monitoring of your Nomad without any sound from the speaker the Recording Output may also be used to drive a pair of headphones. Extreme caution should be used to avoid damaging your ears or the headphones since the level is optimized for consoles ...making it a bit hot for the headphone application. Start with the Channel MASTER Controls off and slowly increase to the desired level.

**BIAS SELECT - Nomad 55 & 100 Models:** Nomad 55 and 100 models incorporate a Bias select switch to enable you to use the stock compliment of 6L6 power pentodes or switch safely to one (or two) pair of EL34 type tubes. Switching from the stock 6L6 harness will revoice the entire amplifier with a distinct emphasis on upper harmonics and a top end spread that may be preferred for certain styles. The 6L6's provide the most balanced response across the wide spectrum of sounds possible in the three channels, but some amazing and different sounds are possible with the EL34's and at some point we suggest experimenting with these tubes...especially in the studio! The multi-track domain puts less emphasis on channel switching versatility and more on specific, identifiable sounds so that any global compromise is not a problem. The EL34's tend to work best in all three channels when they are used in conjunction with lower GAIN and higher MASTER or OUTPUT Control settings...turning up the power amp showcases their classic response best. Channel 1 in both modes is our favorite attitude adjustment, with low GAIN Control settings in Channels 2 & 3 following close behind due to slightly decreased focus - as compared with the 6L6's.

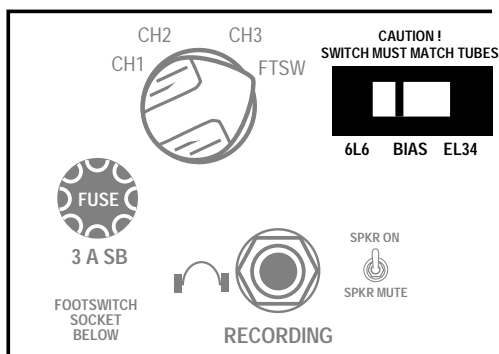

**NOTE:** The BIAS SELECT MUST BE SET TO MATCH THE TUBES IN USE ! Failure to check this switch could result in damage to your amplifier. ALWAYS CHECK THE BIAS SELECT WHEN SWAPPING TUBE TYPES !

## REAR PANEL CONTROLS & CONNECTIONS: *(Continued)*

**SEND, RETURN & FX MIX:** Your Nomad is fitted with a parallel effects loop to provide optimum interfacing of outboard signal processing. In this way the maximum amount of pure amp signal with its attack character and warmth is retained because a large amount of dry amp sound can be mixed with a small amount of a very wet processed signal. To use the Effects Loop for your processors follow these steps.

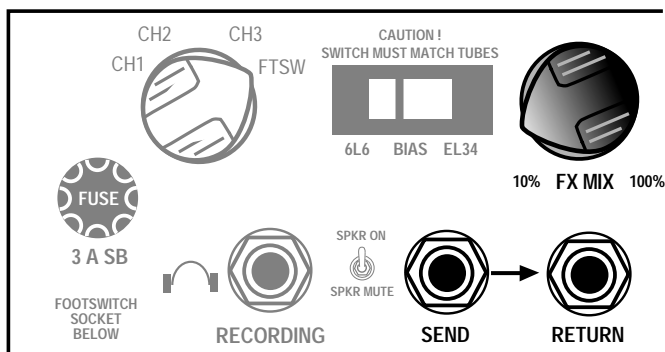

Using 2 good quality shielded cables of the shortest possible length -

- 1.) Connect the SEND to your processors Input.
- 2.) Connect the RETURN to your processors Output.
- 3.) Choose your Modes and sounds in all Channels and balance the levels with the MASTER Control.

4.) Since the MASTER Controls the amount of signal that appears at the SEND try to achieve a relative balance between the Channels with the MASTER Control (of each respective channel) set somewhere between ( 9:00 - 1:00 ). Adjust the overall listening level with the OUTPUT Control.

5.) Set your Processors Dry/Wet mix as close to 100% Wet ( all effect ) as possible.

6.) Dial in the amount of processed signal you wish to use with the FX MIX Control. Remember that the least amount of degradation to your Nomads true sound will be found in the lower range of the FX MIX pot. Set as close to 10% as possible in order to retain attack and warmth .

NOTE: Any foreign device connected to this extremely sensitive point between the pre and power stage will change the sound in some way. The parallel Effects Loop in your Nomad will allow you to use external processing with the least compromise. Effects pedals and External Pre-amp devices should be used in front of the amp ( Connected to the Input and not in the Effects Loop )

NOTE: Do Not Increase Gain at the Effects Loop Beyond Unity with your processors input or output controls. Doing so will connect input to output and feedback will occur. If this happens you will need to reduce either or both until unity gain is reached. Certain extreme settings of GAIN / MASTER Control combinations may not fit the parameters of Send level balance between channels. In such cases try to achieve the sound in a different channel or sacrifice using the Loop for that particular sound in that channel. If you must for a certain device that you absolutely have to use, call us and we will send you a pot that may be of some help. Replacing the standard pot will have adverse effect on the pure un-effected sound of your Nomad.

**POWER AMP (Voicing) : Nomad 45 Only** This two position toggle switch is a bonus feature and rewards those loyal to the littlest Nomad...the small but mighty 45. This switch reconfigures the negative feedback circuit of this little dynamo and allows two distinct power responses from the 4 x EL84 harness. "Normal" wires in the magic amount of negative feedback, producing a warm, round, bubbly response. This position is where you will find the most balanced clean sounds and vocal overdrive sounds. We would suggest the Normal position for most of your channel switching needs.

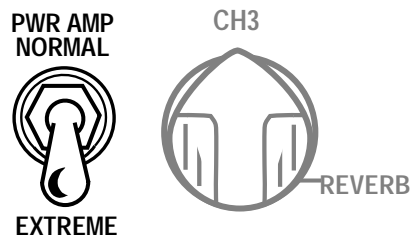

"Extreme" unleashes the fury of this aggressive mid-wattage power section and allows a more traditional Euro style response. The early British EL84 amps barked an urgent, fast attack and screamed with a brash, rebellious nature. Negative feedback is stripped away in this Extreme rendition to arrive at the most forward of all Nomad personalities. This is especially showcased in the Normal mode of Channel 1, with the "PUSHED" Mode adding yet an even nastier realm of "aggro" edge.

NOTE: A Substantial Volume Increase will Occur When Switched To Extreme. Reduce The Output Level When Switching To Extreme.

## REAR PANEL CONTROLS & CONNECTIONS: (Continued)

**50 / 100 WATT : (Nomad 100 Only)** This is the "half power" switch found only on the 100 watt Nomad. The two inside power tubes are put in a standby mode when the 50 watt position is selected reducing the RMS power to approximately 50 watts. This switch may be operated at any time during performance.

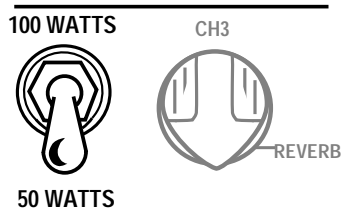

For optimum performance it is recommended that you change the speaker or cabinet from the 8 ohm to the 4 ohm jack when switching down to the 50 watt position. This ensures a proper impedance match by keeping the relative load the same. By doing so a brighter, bouncier response will appear and the full 50 watts of power will be available to you.

If you prefer the fatter, darker nature of the speaker in the 8 ohm jack when in the 50 watt position you may feel free to use this scenario with no harm to the amplifier.

**REVERB:** These three rotary controls are responsible for the dry/wet mix of the traditionally rich analog three spring reverb circuit. Each Channel has a corresponding Reverb Mix Control so that the amount of wet signal can be matched to the style of sound dialed up in that channel. The REVERB can be remotely bypassed globally ( all channels/modes ) with the Reverb switch on the Footcontroller.

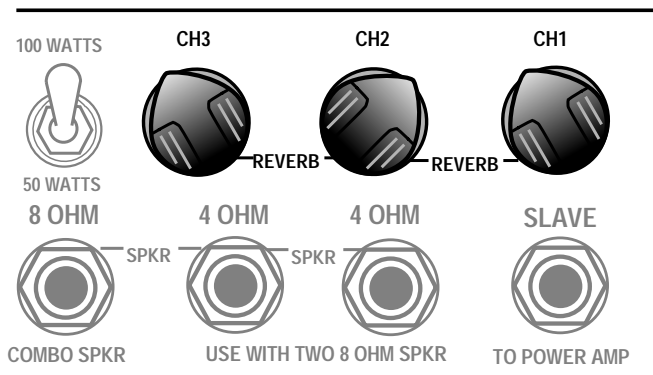

They are placed "backwards" (3,2,1) on the Rear Panel so that when playing the amplifier from the front, the REVERB Controls follow the sequence of the channels...allowing you to reach over and use them without having to look at them.

NOTE: When the Reverb Footswitch is used to disengage the Reverb, a small amount of wet signal can still be heard. To completely remove the Reverb from the circuit, turn the REVERB Control ( of the respective channel ) all the way off.

**SPEAKERS:** Three speaker output jacks (1) 1 x 8 ohm and (2) 2 x 4 ohm are provided to interface your Nomad to a variety of speaker / cabinet configurations. Nomad self-contained combos use the 8 ohm jack for their output and while this is the proper load, you may experiment with mismatching ( in the high direction ) with the inability to produce full power being the only downside. Some players prefer a mismatch, citing a scoop or softening effect they like better than the attack and presence of a proper impedance match.

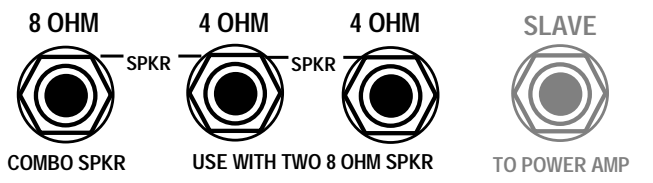

If you wish to add cabinets to your combo or head - you may use either one ( only ) 4 ohm cabinet on the 4 ohm jack leaving the 8 ohm jack empty or two 8 ohm cabinets each connected to the 4 ohm jacks

thus leaving the 8 ohm jack empty and be assured of a proper match as well as full power capabilities. You may also use a 16 ohm cabinet on the 8 ohm jack - and a 8 ohm cabinet on a 4 ohm jack ( leaving one 4 ohm jack empty ). This combination would yield the proper impedance match. See Speaker Impedance Section later in this manual for more information.

NOTE: Nomad 100 owners should put the 8 ohm speaker/cabinet in the 4 ohm jack when switching the 50/100 Power Switch down to 50 watts to ensure a proper impedance match.

## REAR PANEL CONTROLS & CONNECTIONS: *(Continued)*

**SLAVE:** This jack captures a signal directly from the speaker jacks and is “padded” to provide a way to use the entire sound ( pre-amp & power stage ) and send it on to other power amplifiers. This enables you to use your Nomad as the master amp in a large venue rig where multiple amps are used for increased coverage. It also can be used to send a signal on to amp switchers or effects processors.

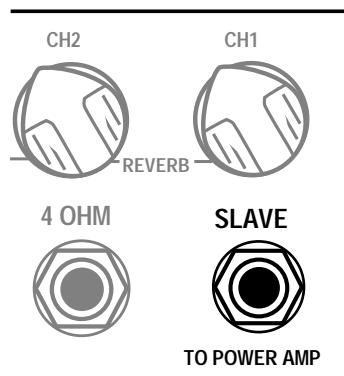

**NOTE:** Unless SPKR MUTE is selected a load of some kind must be used at all times to prevent damage to the amplifier. Your warranty does not cover damage inflicted from use of the amplifier without a load. If a speaker is not possible - use a 4 or 8 ohm resistor of at least a 50 watt rating. A speaker would be the preferred load as it will react dynamically as it changes in impedance according to frequency.

**NOTE:** The Slave level is determined by the setting of both Channel MASTERS and the OUTPUT / SOLO Controls. If an optimum level is not possible due to either extreme or very low performance levels - you may call us and we will send you a diagram of how to modify the Slave level ratio to your individual needs. Before you do this try it with all the possible ways you may need it in case it is only one scenario that is compromising. We selected this ratio for normal performance applications and it should be adequate for most situations.

# CHANNEL 1 - Factory Sample Setting Page

NOTE: All Settings pertain to all Nomad Series amps

## CHANNEL 1 - Warm Vintage Clean

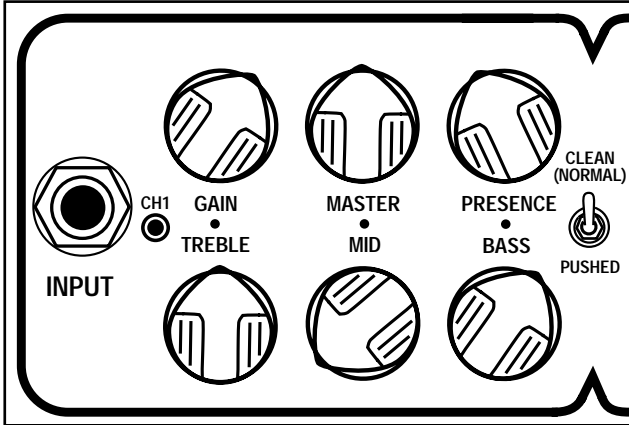

## Neck Single or Humbucker

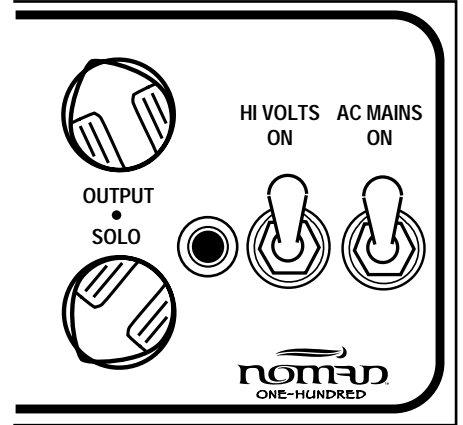

## CHANNEL 1 - Hyper Clean

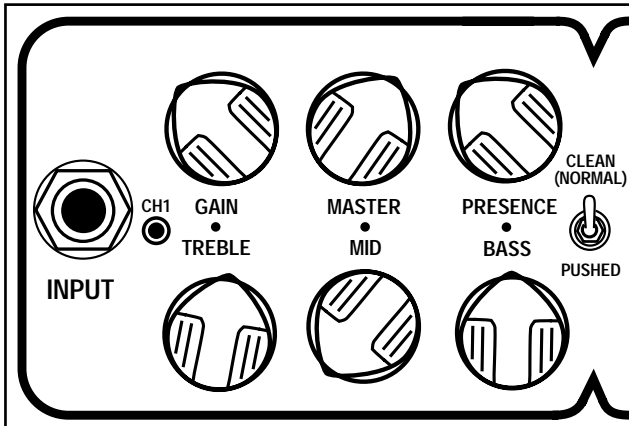

## Low Output Pick-Ups

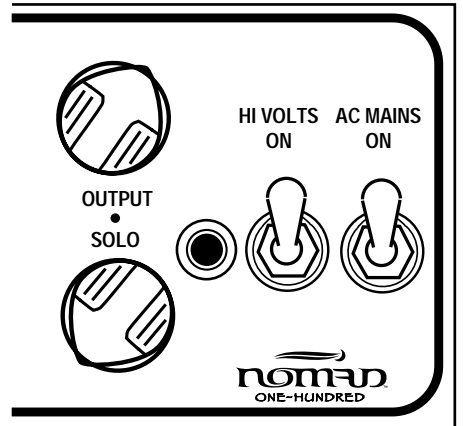

## CHANNEL 1 - Twang

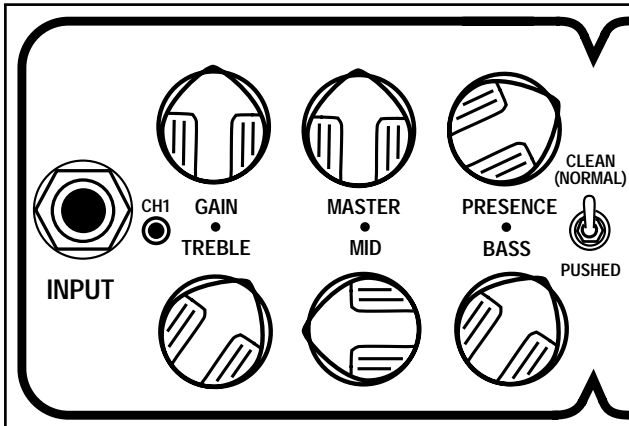

## Strat / Tele Style

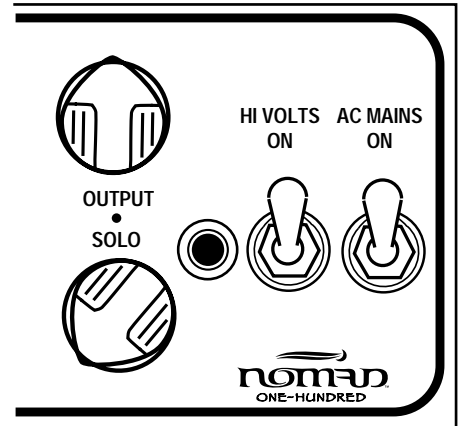

# CHANNEL 1 - Factory Sample Setting Page

NOTE: All Settings pertain to all Nomad Series amps

## CHANNEL 1 - Warm & Round

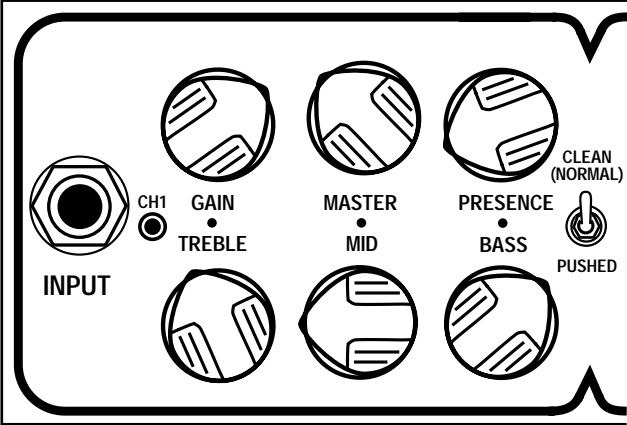

## Neck Single or Humbucker

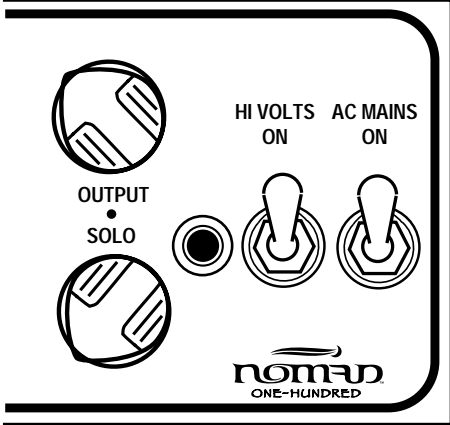

## CHANNEL 1 - Old School

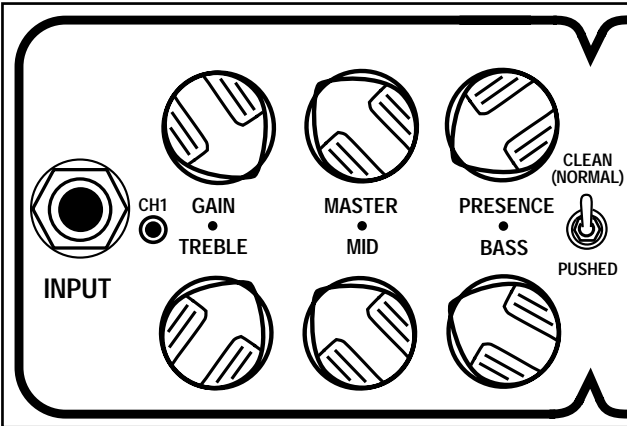

## Most Pick-Ups

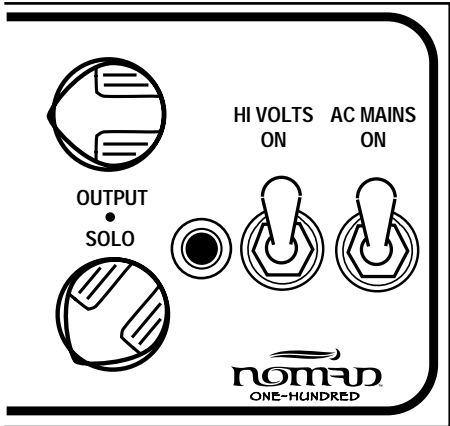

## CHANNEL 1 - Classic Rock

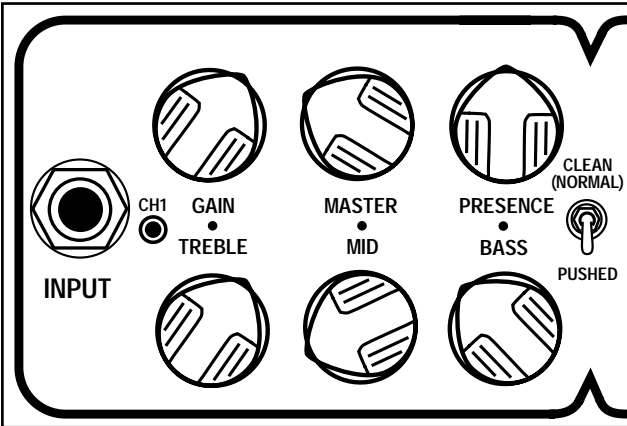

## Rear Humbucker

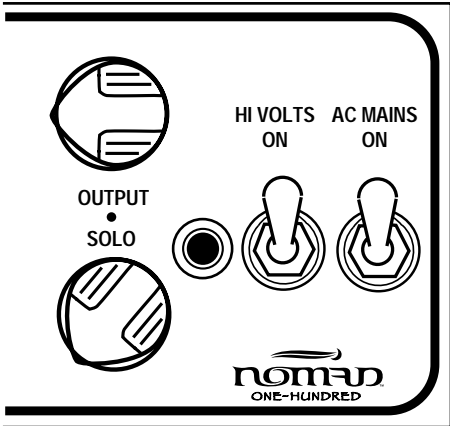

# CHANNEL 1 - Factory Sample Setting Page

NOTE: All Settings pertain to all Nomad Series amps

## CHANNEL 1 - Agro Crunch

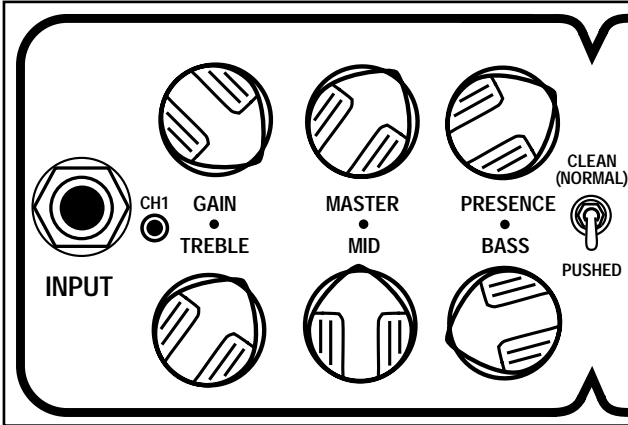

## Hot Rear Humbucker

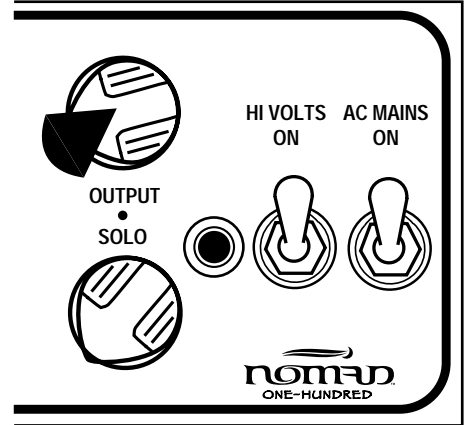

## CHANNEL 1 - Fast Track Solo

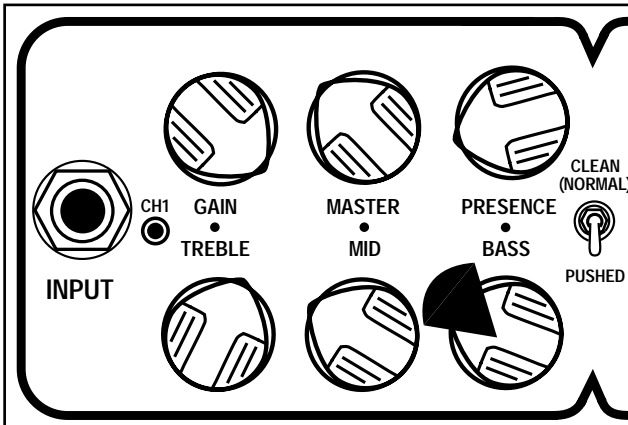

## Most Pick-Ups

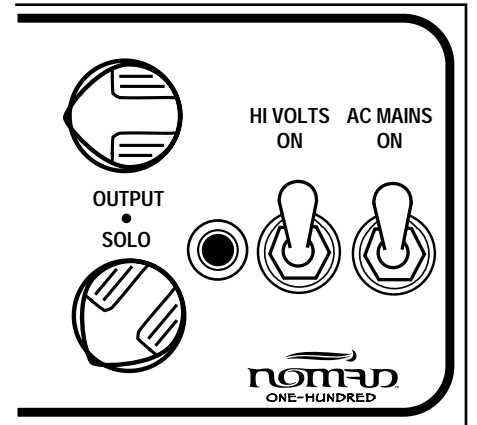

## CHANNEL 1 - Mid Punch Clean

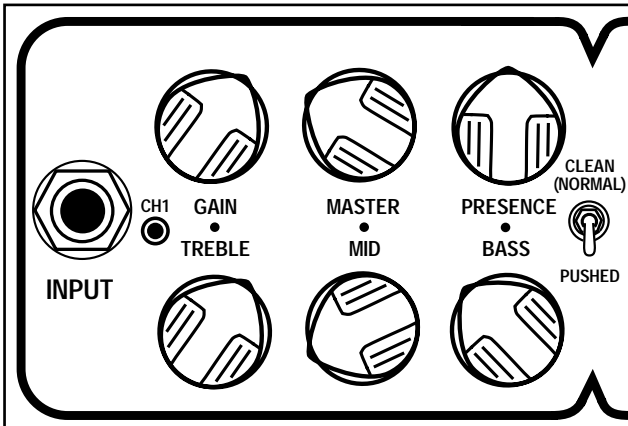

## Neck Single

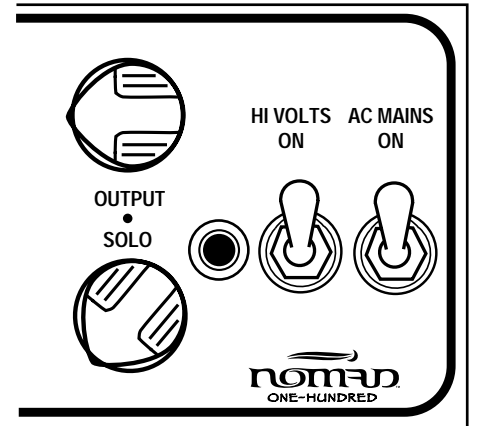

# CHANNEL 2 - Factory Sample Setting Page

NOTE: All Settings pertain to all Nomad Series amps

## CHANNEL 2- Fat & Purring

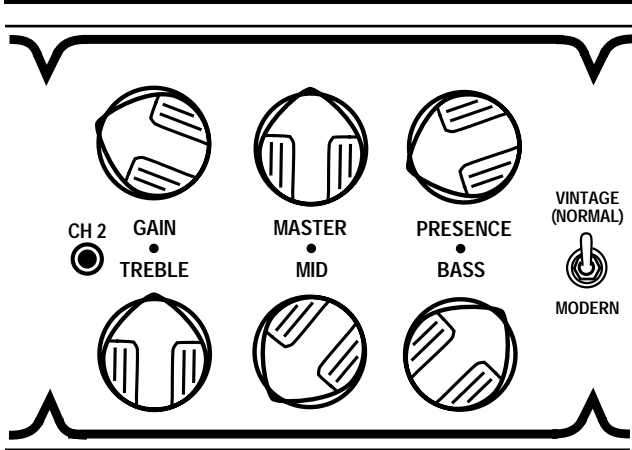

## Neck

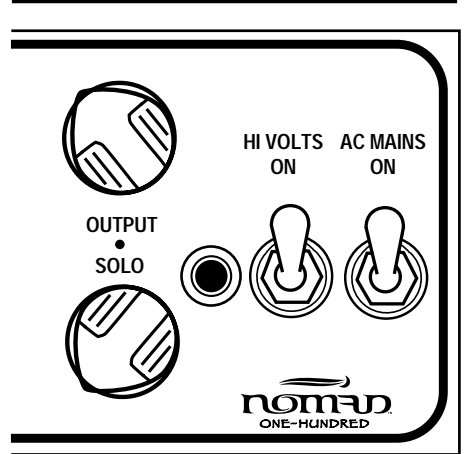

## CHANNEL 2 - Violin Vibe

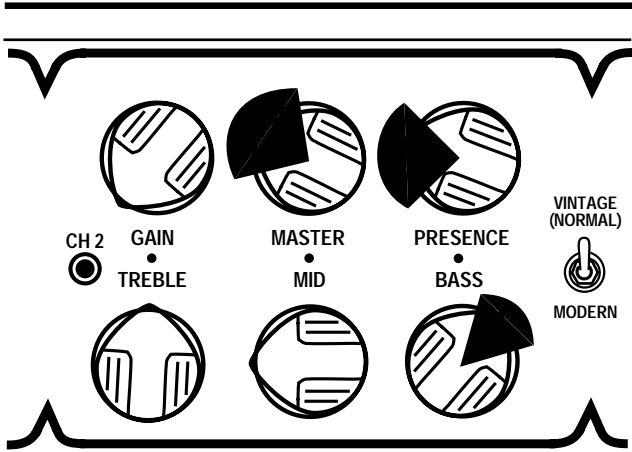

## Most Pick-Ups

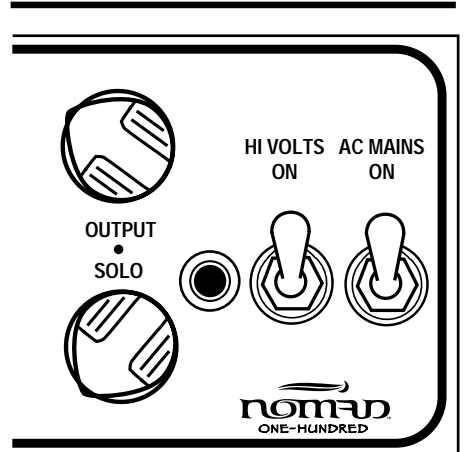

## CHANNEL 2 - Pretty Clean & Brown

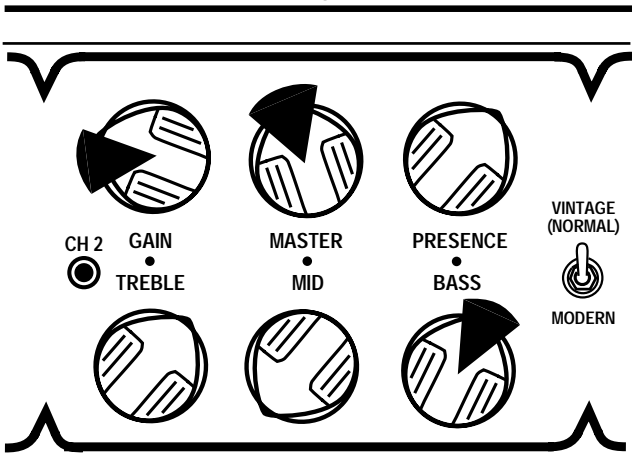

## Neck or Multiple

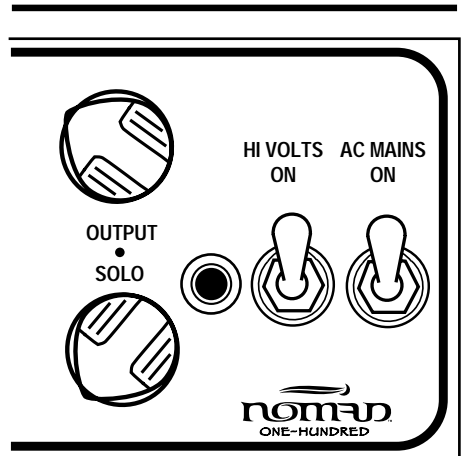

# CHANNEL 2 - Factory Sample Setting Page

NOTE: All Settings pertain to all Nomad Series amps

## CHANNEL 2- Rotundo

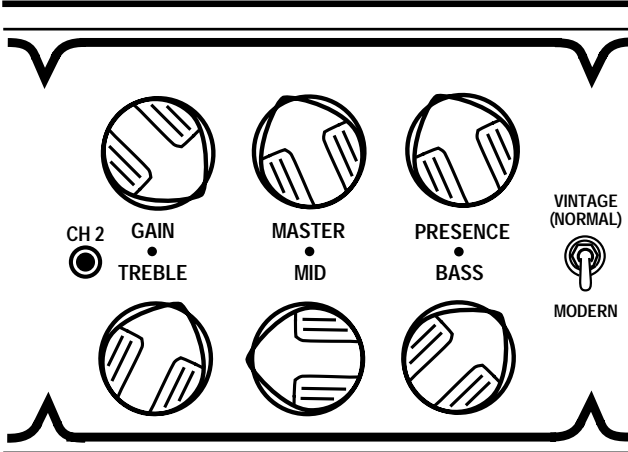

## Hot Rear Humbucker

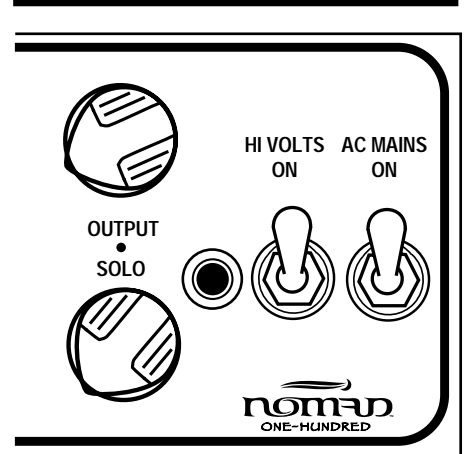

## CHANNEL 2 - Edge

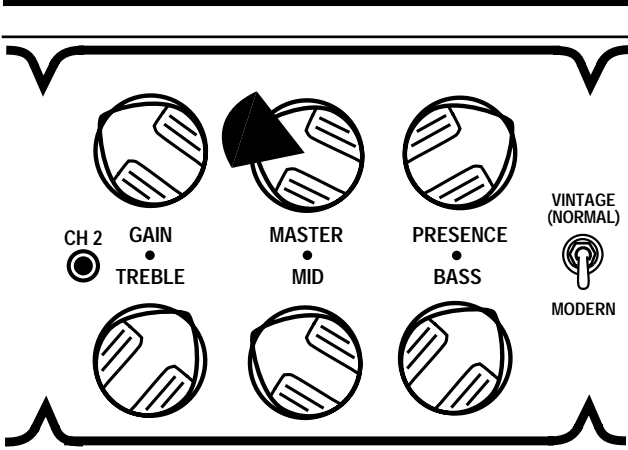

## Most Pick-Ups

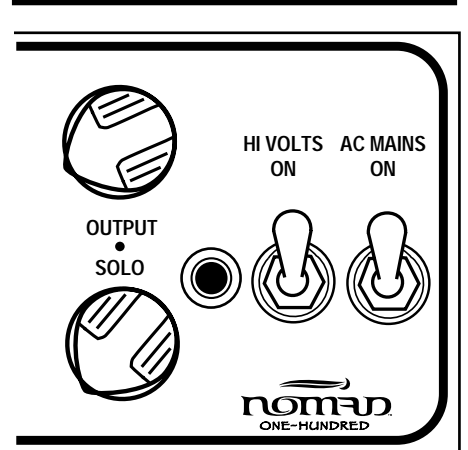

## CHANNEL 2 - Agro Solo

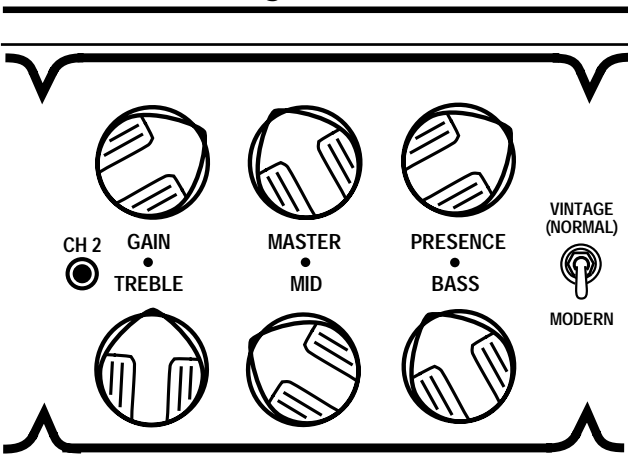

## Hot Rear Humbucker

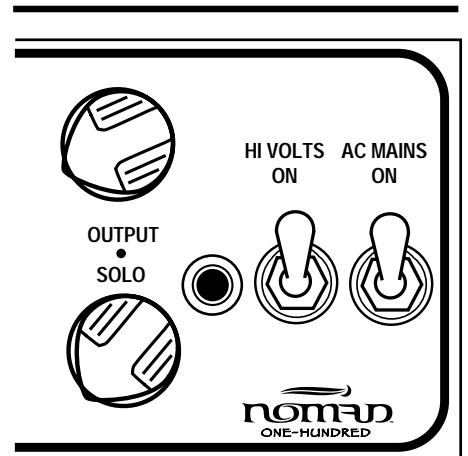

# CHANNEL 3 - Factory Sample Setting Page

NOTE: All Settings pertain to all Nomad Series amps

## CHANNEL 3 - Mocombo™

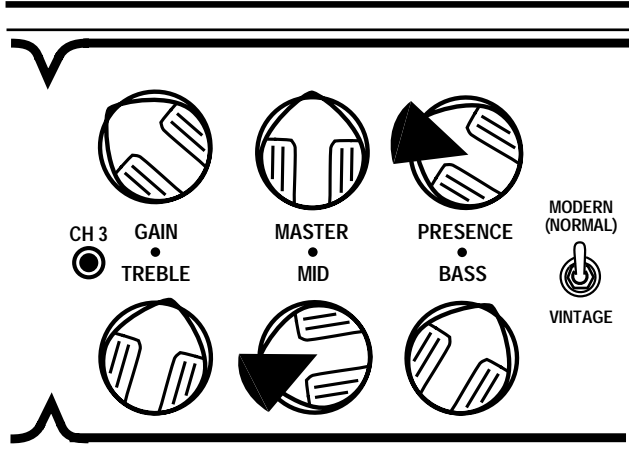

## Strat, Tele Style

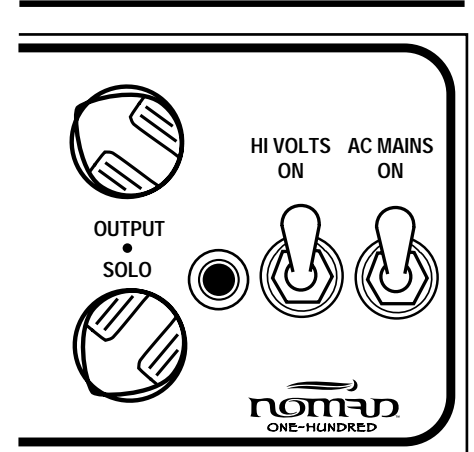

## CHANNEL 3 - Clean Clone

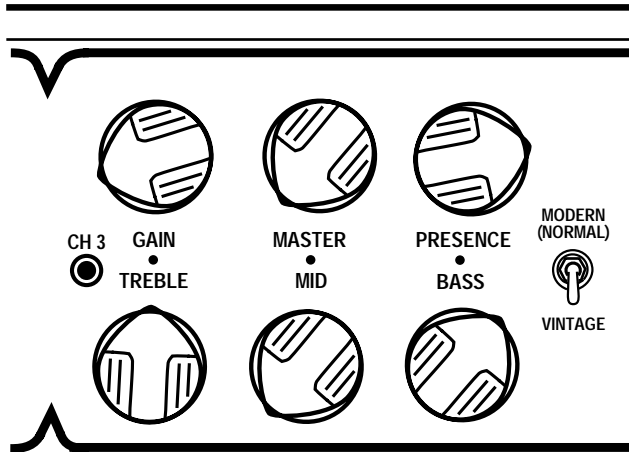

## Most Low Output Pick-Ups

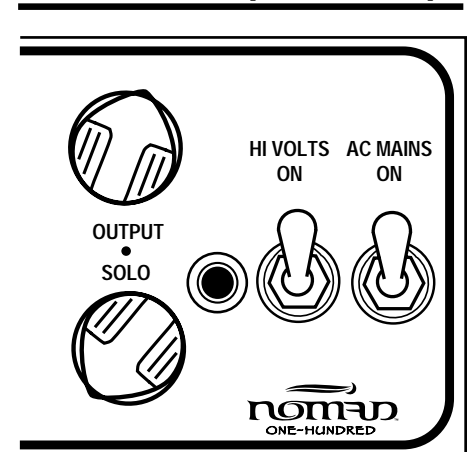

## CHANNEL 3 - Rocked Out

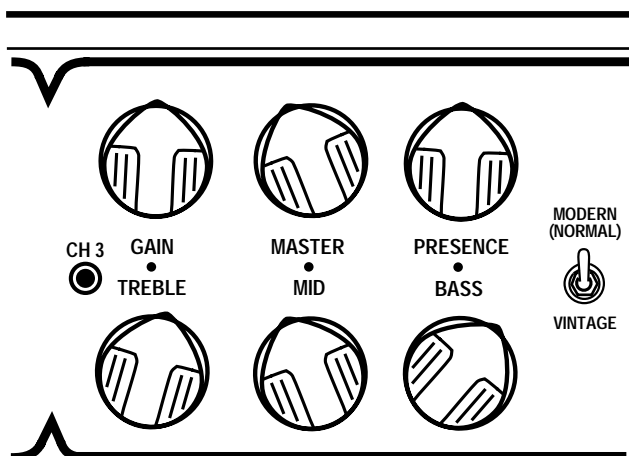

## Hot Rear Humbucker

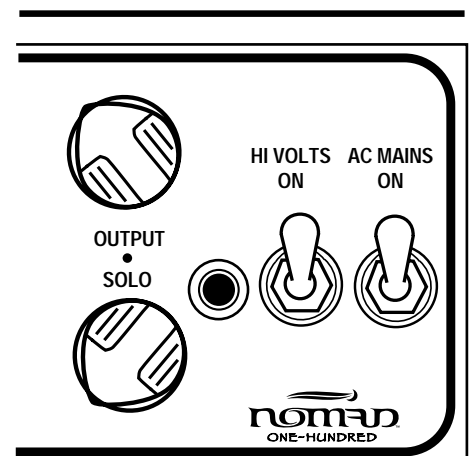

# CHANNEL 3 - Factory Sample Setting Page

NOTE: All Settings pertain to all Nomad Series amps

## CHANNEL 3 - Flat Out

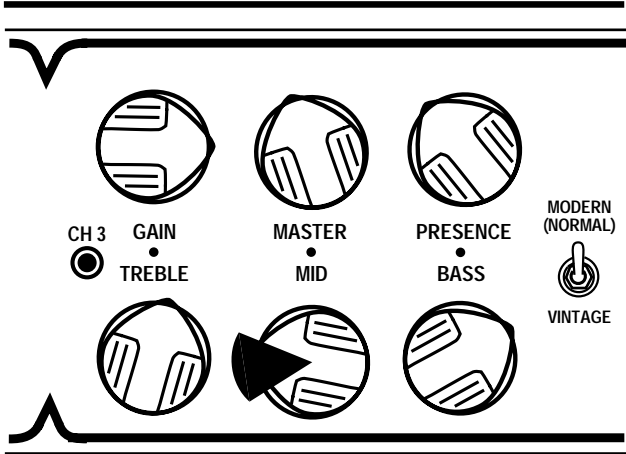

## Hot Rear Humbucker

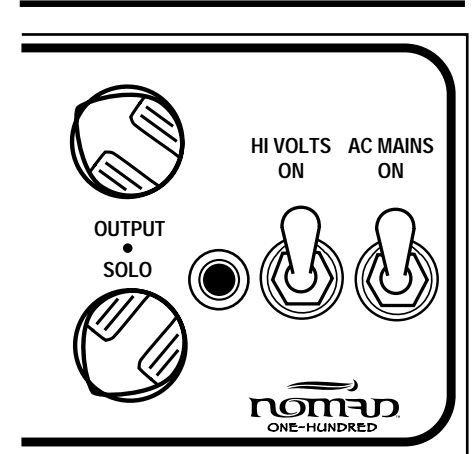

## CHANNEL 3 - Blues Punch

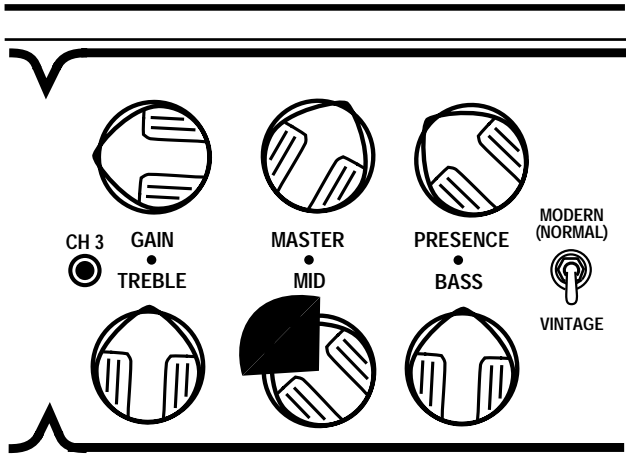

## Most Pick-Ups

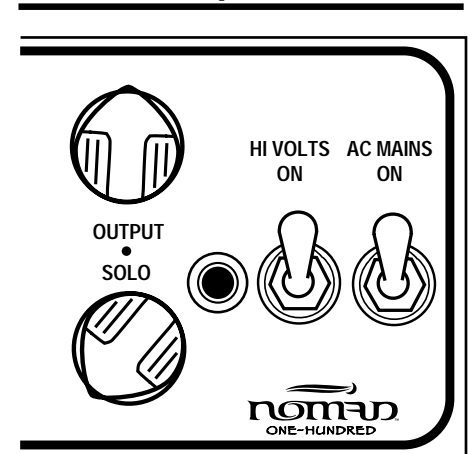

## CHANNEL 3 - Implosion

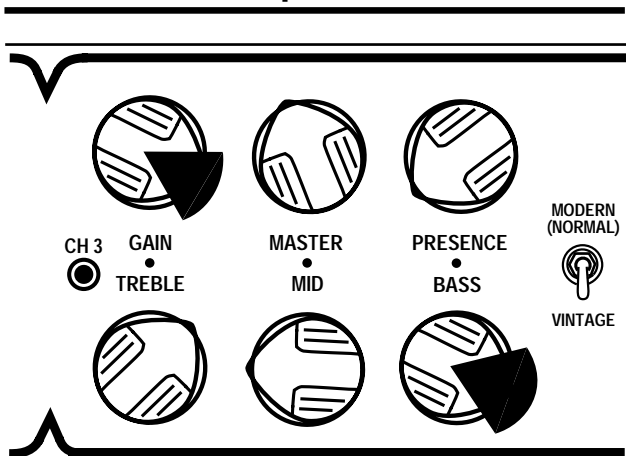

## Hot Rear Humbucker

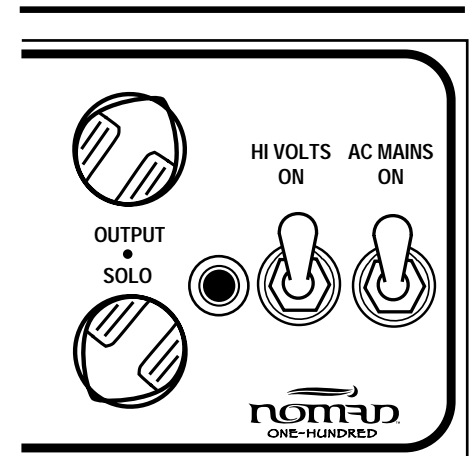

# Nomad 45 TUBE TASK CHART

View looking down on to chassis (as if looking down through the cabinet)

NOTE: Before changing tubes, turn the POWER SWITCH to the off position or to STANDBY. CAUTION..Tubes are HOT when they have been in use.

Partial View Of Chassis

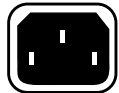
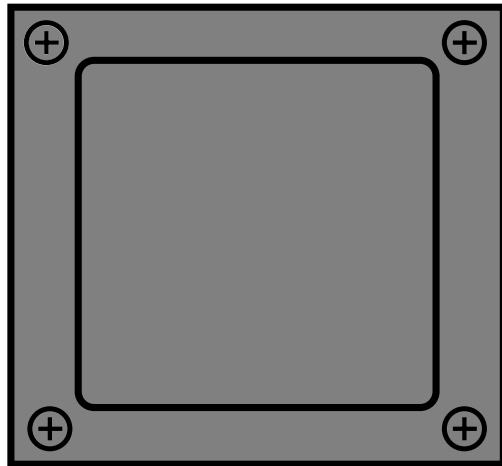

AC Receptacle



Footswitch DIN plug

(Each 12AX7 contains two separate Triodes)

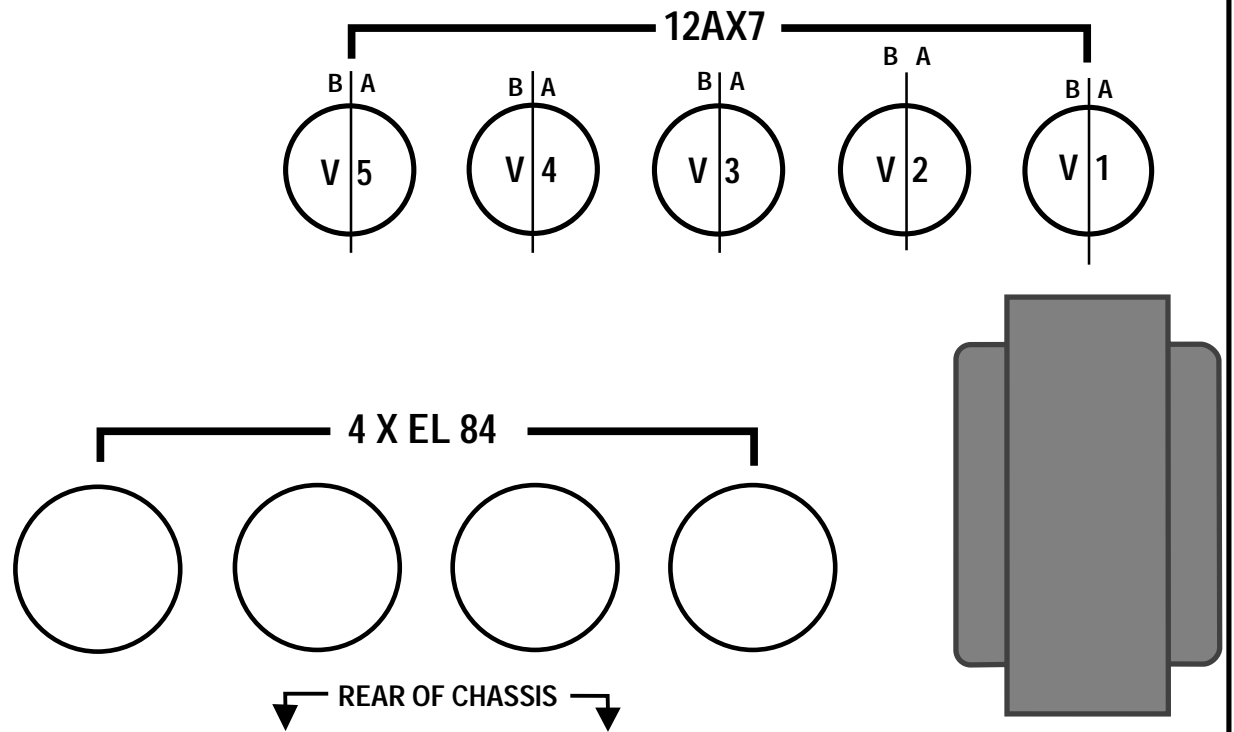

PAGE 26

## Description of Tube Functions

- |                                     |                                |
|-------------------------------------|--------------------------------|
| V1 A & B = (paralleled) input stage | V4 A = 2nd Stage Channel 2 & 3 |
| V2 A = 2nd Stage Channel 1          | V4 B = FX Return Stage         |
| V2 B = 3rd Stage Channel 1          | V5 A & B = Phase Inverter      |
| V3 A = 4th Stage Channel 2 & 3      |                                |
| V3 B = 3rd Stage Channel 2 & 3      |                                |

# Nomad 55 TUBE TASK CHART

View looking down on to chassis (as if looking down through the cabinet)

NOTE: Before changing tubes, turn the POWER SWITCH to the off position or to STANDBY. CAUTION..Tubes are HOT when they have been in use.

Partial View Of Chassis

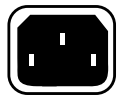
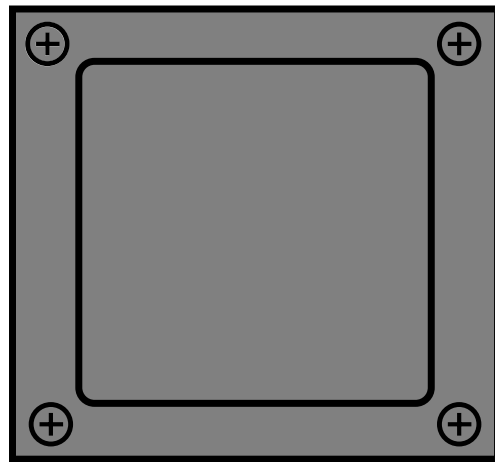

AC Receptacle



Footswitch DIN plug

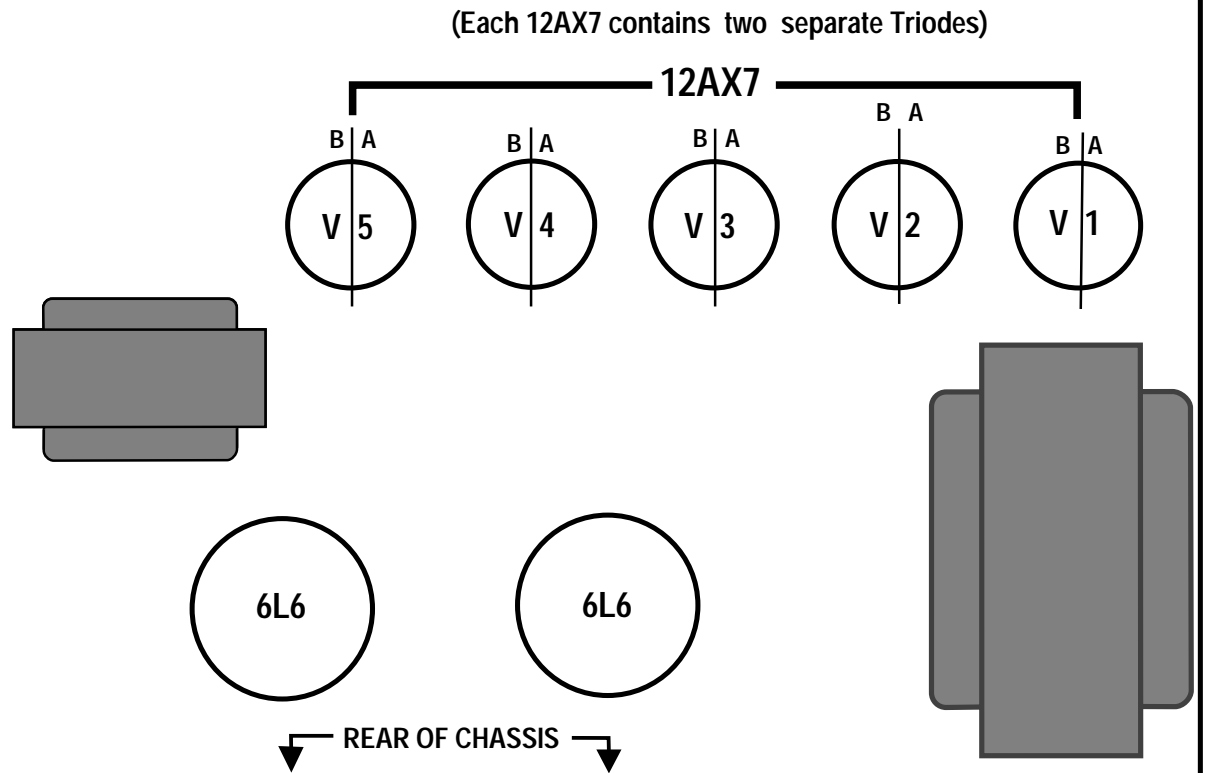

## Description of Tube Functions

- |                                     |                                |
|-------------------------------------|--------------------------------|
| V1 A & B = (paralleled) input stage | V4 A = 2nd Stage Channel 2 & 3 |
| V2 A = 2nd Stage Channel 1          | V4 B = FX Return Stage         |
| V2 B = 3rd Stage Channel 1          | V5 A & B = Phase Inverter      |
| V3 A = 4th Stage Channel 2 & 3      |                                |
| V3 B = 3rd Stage Channel 2 & 3      |                                |

# Nomad 100 TUBE TASK CHART

View looking down on to chassis (as if looking down through the cabinet)

NOTE: Before changing tubes, turn the POWER SWITCH to the off position or to STANDBY. CAUTION..Tubes are HOT when they have been in use.

Partial View Of Chassis

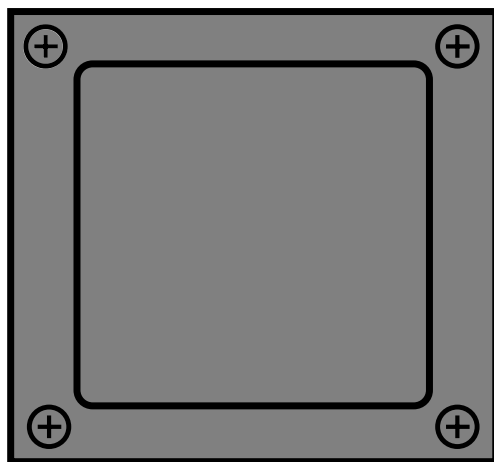

AC Receptacle



Footswitch DIN plug

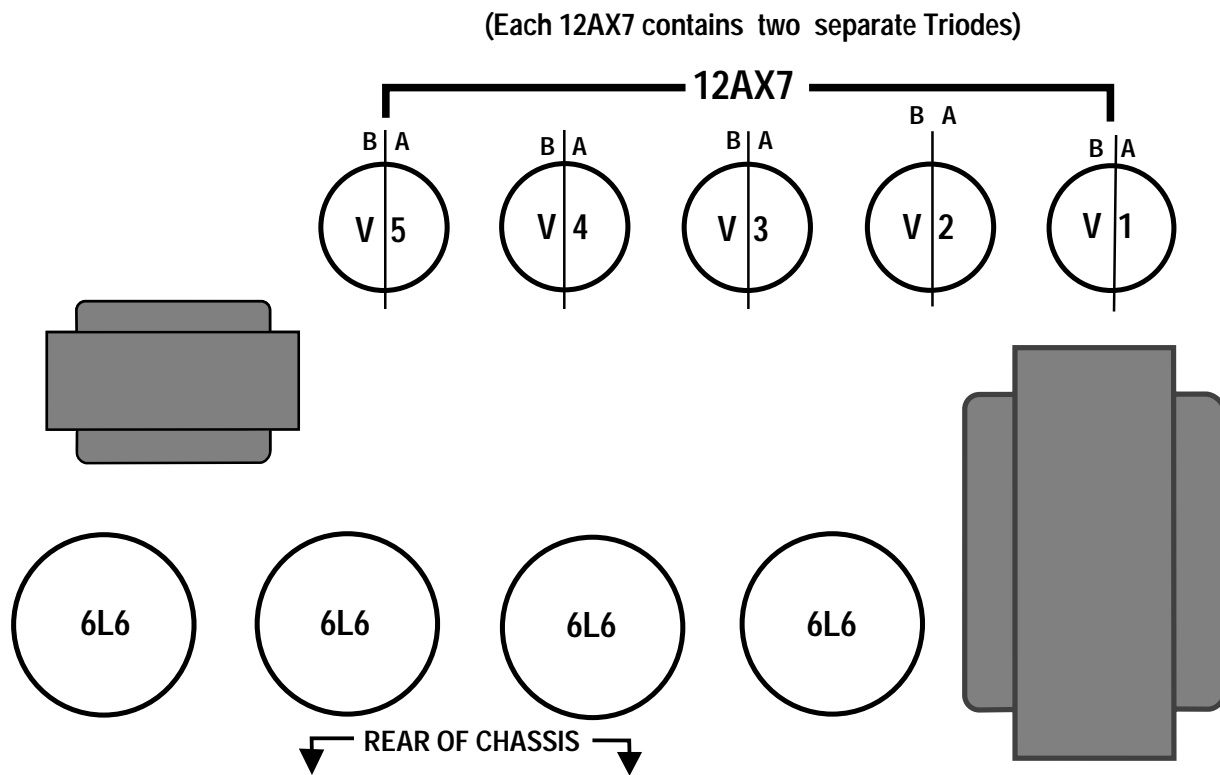

## Description of Tube Functions

- |                                     |                                |
|-------------------------------------|--------------------------------|
| V1 A & B = (paralleled) input stage | V4 A = 2nd Stage Channel 2 & 3 |
| V2 A = 2nd Stage Channel 1          | V4 B = FX Return Stage         |
| V2 B = 3rd Stage Channel 1          | V5 A & B = Phase Inverter      |
| V3 A = 4th Stage Channel 2 & 3      |                                |
| V3 B = 3rd Stage Channel 2 & 3      |                                |

## **TUBE NOISE & MICROPHONICS**

You may occasionally experience some form of tube noise or microphonics. Certainly no cause for alarm, this quirky behavior comes with the territory and the Tone. Much like changing a light bulb, you don't need a technician to cure these types of minor user serviceable annoyances and in fact, you'll be amazed at how easy it is to cure tube problems...by simply swapping out a pre-amp or power tube!

First may we suggest that you set the amplifier up on something so that you can get to the tubes comfortably without having to bend down. It also helps to have adequate lighting as you will need to see the tube sockets clearly to swap tubes. Use caution and common sense when touching the tubes after the amplifier has been on as they may be extremely hot! If they are hot and you don't want to wait for them to cool off, try grasping them with a rag and also note that the glass down around the bulbous silvery tip is considerably less hot which makes it easier to handle. Gently rock the tube back and forth as you pull it away from its socket.

## **DIAGNOSING POWER TUBE FAILURES:**

There are two main types of tube faults: shorts and noise. Both large and small tubes may fall prey to either of these problems but diagnosis and remedy is usually simple.

If a fuse blows, the problem is most likely a shorted power tube and shorts can either be mild or severe. In a mildly shorted tube the electron flow has overcome the control grid and excess current flows to the plate. You will usually hear the amp become distorted and begin to hum slightly. If this occurs, quickly look at the power tubes as you switch the amp to STANDBY and try to identify one as glowing red hot. It is likely that two of a pair will be glowing since the "shorted" tube will pull down the bias for its adjacent mates, but one tube may be glowing hotter — and that one is the culprit. The other two are often fine — unless they've been glowing bright red for several minutes.

Because there is no physical short inside the tube (just electrons rioting out of control) merely switching to STANDBY for a few moments then back to ON will usually cure the problem...at least temporarily. Watch the tubes carefully now. Should the problem recur, the intermittent tube will visibly start to over heat before the others and thus it can be identified. It should be replaced with one from the same color batch, shown on its label. Call us and we will send one out to you.

The severe short is not nearly so benign. In the worst cases, a major arcing short occurs between the plate and the cathode with visible lightning inside the glass and a major noise through the speaker. If this is seen to happen, IMMEDIATELY turn the amp to STANDBY. By this time the fuse probably will have blown. Such a short is usually caused by a physical breakdown inside the tube including contaminate coming loose or physical contact (or near contact) between the elements. Replace it and the fuse with the proper slo-blo type and power up the amp using the power up procedure as we described earlier in this manual.

**TUBE NOISE:** Often caused by contamination within a tube, the culprit can usually be identified, and by lightly tapping on the glass, you will probably hear the noise change. Hearing some noise through the speakers while tapping on the 12AX7's is normal however. And the one nearer the INPUT will always sound louder because its output is being further amplified by the second 12AX7.

The power tubes should be all but quiet when they are tapped. If crackling or hissing changes with the tapping, you have probably found the problem. To confirm a noisy power tube, merely put the Nomad on Standby, remove it from its socket and turn it back on. It will cause no damage to run the Nomad briefly with one power tube missing. You may notice a slight background hum, however, as the push-pull becomes unbalanced. Whenever you are trying to diagnose a suspect tube, keep your other hand on the POWER and STANDBY switches ready to shut them off instantly in the unlikely case you provoke a major short.

If you think you've located a problem tube but aren't sure, we recommend substituting the suspect with a new one just to be sure of your diagnoses. You will be doing yourself and us a big favor by just following the simple guidelines previously mentioned regarding tube replacement. You'll probably be successful with much less effort than is required to disconnect everything and haul the unit to a technician who will basically perform the same simple tests. If the tubes are still within their six-month warranty period, we will happily send you a replacement. Just note the color designation on the tube label so that we can send you the appropriate match.

**DIAGNOSING PRE-AMP TUBE PROBLEMS:** Because your amplifier is an all tube design, it is quite possible that you will at some point experience minor pre-amp tube noise. Rest assured - this is no cause for alarm and you can take care of the problem yourself in a matter of minutes by simply swapping tubes.

Let us begin by saying; It is a "very good" idea to keep at least a couple of spare pre-amp tubes on hand at all times to insure uninterrupted performance. These minor pre-amp tube problems can take many forms but can generally be described in two categories: Noise and Microphonics. Noise can be in the form of crackling, sputtering, white noise/hiss and/or hum. Microphonic problems usually appear in the form of a ringing or high pitched squealing that gets worse as the gain or volume is increased thus are more noticeable in the higher gain "HI" modes. Microphonic problems are easily identified because the problem is still present even with the instruments' volume off or unplugged altogether - unlike pick-up feedback which ceases as the instrument is turned down. Microphonic noise is caused by mechanical vibration and shock: think of banging a microphone around and you'll understand where the word came from.

The best way to approach a pre-amp tube problem is to see if it occurs only in one specific mode or channel. This should lead you to the tube needing replacement. Then all that remains is to swap the suspect tube for a known good performer.

If you cannot narrow down the trouble to a specific mode or channel, the problem may be the small tube that drives the power tubes which is operational in all modes and channels. Though rare, a problem with the driver tube would show up in all aspects of performance - so if you can't narrow the problem down to being mode or channel specific, you may want to try replacing the driver tube. Driver problems generally show themselves in the form of crackling or hum in all modes of performance and/or weak overall output from the amplifier. Occasionally an anemic driver tube will cause the amplifier to sound flat and lifeless, but this is somewhat uncommon, as worn power tubes are a more likely suspect for this type of problem.

Sometimes making the diagnosis is more trouble than it's worth and it's faster and easier to merely replace the small pre-amp tubes ONE AT A TIME with a replacement known to be good. But MAKE SURE you keep returning the tubes to their original socket until you hit the one that cures the problem. You'll notice that tubes located nearer to the INPUT jack always sound noisier...but this is because they are at the start of the chain and their noise gets amplified over and over by the tubes that follow. The tube that goes into this "input socket" (usually labeled V1) needs to be the least noisy of the bunch. The tube that goes at the end of the preamp chain - just ahead of the power tubes - can be quite noisy without causing any problem at all. The tubes in your amp have already been located in the most appropriate sockets and this is why you should NEVER pull them all out at once and ALWAYS swap them one at a time. ALWAYS return a perfectly good tube to its original socket. Also it's a good idea to put the amp on STANDBY when swapping tubes to reduce the heat build up in the tubes themselves and to prevent explosive noises (which can still occur even if you are pulling the tubes away from their sockets gently) from coming through the speaker.

Remember, take your time, be patient and chances are real good that you can fix your amp yourself by finding and replacing the bad tube. It kills us to see someone who has shipped their amp back to us...and all it needed was a simple tube replacement! If you must send back your amp, unplug the power cord, speaker and reverb cables then remove the chassis from the cabinet by unscrewing the four mounting bolts on top. The chassis then slides back like a drawer and comes out. Remove the big power tubes and mark them according to their location from left to right 1, 2 etc. They need to be wrapped separately with plenty of wadded up newspaper around them and put in a smaller box within the larger carton.

To wrap the chassis, use plenty of tightly wadded up newspaper so there is at least six inches of "crush space" between the chassis and the cardboard box. Bubble wrap also works well, but please DON'T use styrene peanuts - they will shift during transit and get lodged inside your electronics as well as allowing your amp to end up at the bottom of the box unprotected and possibly damaged. Pre-amp tubes don't normally wear out as a rule.

Therefore, it is not a good idea to change them just for the sake of changing them. If there isn't a problem - don't fix it. If there is no result from your substitutions, it may be possible that you have more than one problematic tube. Though rare, this does happen and though it makes the troubleshooting process a little more intimidating, it is still possible to cure the problem yourself.

NOTE: It is normal to hear a slight metallic ringing sound when tapping on the preamp tubes. As long as the tube does not break into oscillation or start crackling or any other form of bizarre noise, it is considered normal and functional.

## BIAS ADJUSTMENT: *(Part of a continuous series)*

An Article written by Randall Smith that we thought you might find interesting.

Here's a question we often hear:

"Why doesn't Mesa put bias adjustments in their amplifiers?"

Well, there's a short answer and a long answer to this question.

The short answer is that during my 12 years of repairing Fenders, one of the most frequent problems I saw was bias controls that were either set wrong or that had wandered out of adjustment due to vibration. As any honest tech will tell you, there's lot's of easy money to be made by sprinkling "holy water" on amplifiers ... uh, what I meant to say is "Your amp needed biasing." See what I mean? What customer is going to argue with that?

It only takes a moment and a volt meter: The Fender diagram shows how: "Adjust this trim pot for - 52 volts." That's it. Nothing more.

Now don't be fooled into thinking that tubes "draw" more or less bias, they don't. The way a bias supply is connected to a tube is akin to a dead end road, it just trails off to nowhere without really completing a circuit. It's a static voltage and regardless of what tube is in the socket — or even if the tubes aren't plugged in at all, it doesn't change the bias voltage a bit.

So the end of the short answer is this: Since a bias supply needs to put out the right voltage and never vary, I wanted to build amplifiers that were individually hard wired to the correct values and NEVER needed adjustment. And for 25 years, that's how Mesa/Boogies have been built.

Time to change tubes? Just plug our tubes into any one of our amps and you're DONE. No tech needed. NO bills and no BS about biasing. And most important: The bias is RIGHT because it can't change!

Now, you want the long answer? Here's more information on how our hard-wired bias avoids trouble. Please read on.

But first, let's make an important distinction. Our business is designing and building high performance amplifiers. And for this we need tubes whose variance is within a narrow range. Our warehouse is full of rejects ...oh, they work — they just don't perform within our tolerance range. We have a very sophisticated computer - based tube testing system (nicknamed "Robotube") that matches and measures tubes over seven important parameters. It can even predict which tubes are likely to have a shortened lifetime — even though they work perfectly during the test.

Because our business is building quality amps, we can afford to reject a lot of wayward tubes. The guys you hear complaining because Boogies don't have bias adjusters are primarily in the business of selling tubes - not amps. They don't want to throw away 30 percent of their inventory, so they promote the idea that tubes outside our parameters can be used to "customize" amplifiers and they criticize us because our amps can't be adjusted to accommodate their out-of-Mesa tolerance tubes.

Now you might be thinking, "But I thought you just said that tubes don't "draw" bias, therefore they don't effect the bias supply and thus it doesn't need to be adjustable."

When you set the bias (whether it's by selecting the right resistors, as we do, or adjusting a trimmer — which is quicker) what you are doing is establishing the correct amount of idle CURRENT that flows through the power tubes. But you can't adjust the current directly, you can only change it by adjusting the amount of bias VOLTAGE that goes onto the tubes' control grids.

Voltage and current are NOT the same. Current is the AMOUNT of electricity, the "quantity" — and is measured in amperes. Voltage is the degree of electric charge — like the "pressure" to use the old water analogy. Let me illustrate how different voltage and current are:

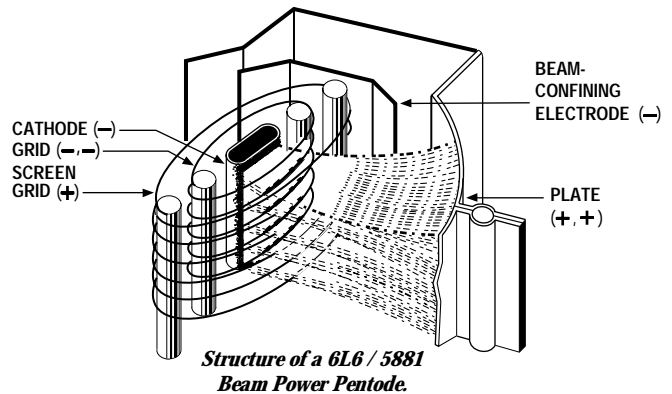

**BIAS ADJUSTMENT: (Continued)** When you scrape your feet across a carpeted floor in dry, wintery conditions, your body can become charged with 50,000 to 100,000 volts of static electricity. And when you reach for the door knob, a spark jumps and you feel it! The voltage is super high but the current (measured in micro-amps) is tiny - otherwise you would die from electrocution.

Contrast this with your car battery, which puts out a mere 12 volts. You can lay your hands right across the terminals and not feel a thing. Yet the amount of current available can run to several hundred amperes .. enough to turn over a cold engine and get it started.

So current and voltage are two totally separate electrical parameters — though when you multiply them together, you get POWER, which is measured in watts.

When you set the bias of an amplifier, you are adjusting the static VOLTAGE at the control grid of the tube in order to produce a desired amount of idle CURRENT flowing to the tube's plate. A small change in grid voltage, produces a large change in the amount of current flowing — and that's basically how a tube works. Say that again because it's super important: A small change in voltage at the grid causes a large change in current flowing to the plate. See, that's the essence of amplification: A small change causing a large change. And here it's a small voltage change causing a large current change.

The bias conditions are what determines how much current flows through the big power tubes when you're not playing. And what drives your speakers is fluctuations in that current flow when ARE playing. If the amount of current increases and decreases 440 times per second, then you'll hear an A note. If the fluctuations in current flow are large and still at 440 per second, you'll hear an A that is LOUD!

But for purposes of biasing, it's the amount of "plate current" flowing with no signal applied that's important. Unfortunately current is hard to measure because the circuit must be interrupted — as in "cut the wire" — and the meter spliced "in series" with the broken circuit. But measuring VOLTAGE is easy. It is not necessary to interrupt the circuit because a voltage reading can be taken in PARALLEL with the circuit intact.

Thus, as a matter of convenience, most bias settings are given in volts at the grid ... even though current through the plate is the important factor. In fact plate current is so inconvenient (and dangerous) to measure that Fender doesn't even state what the correct value should be. They only give the grid voltage that will produce that current. (That's the minus 52.) But that only happens if the tubes being used are "in spec."

As long as the tubes ARE "in spec", the right bias voltage will always give the correct plate "CURRENT" — but then there's no need for the bias voltage to be adjustable!

If the tubes are NOT in spec, then the only proper way to re-set the bias is to cut the circuit and measure the current while adjusting the bias ... but no manufacturer I know even STATES the desired current value! Be that as it may, when the original bias voltage is altered far enough, it will compensate for the tube's abnormal performance and the correct amount of idle current flow may then be restored. Clearly this is something most repair techs should not attempt.

Some newer amps have LED indicators connected to the circuit which will turn on when the right threshold of current flow has been reached. This is an improvement, and almost worthy if you're willing to except resistors and lights added into your amplifier's audio path — which we aren't. The other "advantage" of this system is that it allows some amp manufacturers to avoid matching their power tubes. The thinking is that adjusting the bias to each tube separately eradicates the inherent differences between the tubes by insuring that the same current flows through each one.

Again, this has some merit .. but it's still not as good as using tubes that are matched in the first place because compensating for the mis-match causes the push-pull circuit itself to become unbalanced. Two wrongs don't really make a right.

Some of the other recommended biasing, "methods" — such as -".. tubes running red hot, increase the bias .. sounds harsh and runs too cool, turn it down ..." are guesswork at best. Luckily, one of the great things about tube amps is that they can usually stand some abuse without causing any real harm ... at least not immediately.

**BIAS ADJUSTMENT: (Continued)** But don't these alterations imply that you are second-guessing the amp designer and that there's a better set of operating conditions that the designer missed but the tube sellers have discovered?

Now some players may like the sound of their amp altered by tubes with extreme characteristics and with the bias set to help compensate. But often it is the mere novelty of change that they're really responding to and when the amp goes back to the proper original way, we've seen them be far happier still!

Because every part in every one of our designs has been meticulously evaluated, compared and stressed over — no matter how seemingly insignificant it might be. And with every design we look for a "sweet spot" where all the parameters — including the bias — come together to give the best sonic performance, consistently and reliably. Every part and voltage is important — yet no one complains that these other parameters aren't available for tinkering.

Consider our patented Simul-Class circuitry where there are two different bias voltages used for separate pairs of power tubes ... and changing one voltage also changes the other. Great care goes into getting this just right and we think we'd be asking for trouble to have it adjustable for the world to play with ... unless you like paying to have your amp messed up. Sorry, I meant to say, "Uh, ... your amp needed biasing."

If that doesn't appeal to you, then merely plug a matched set of Mesa tubes into one of our amps and you're ready for tone. Guaranteed. You'd be amazed at the number of service calls we field every day that lead to a diagnosis of out-of-tolerance, non-spec tube problems. To think these would be prevented by including a bias adjustment is something of an insult to you and us. If you put the wrong size tires on your car, do you think changing the pressure will make them right?

Please, don't think this is a blanket indictment of the other guys selling tubes — it isn't. And their tubes aren't all bad either. It just doesn't make sense to pay more of your hard earned cash for tubes that were probably made in the same Russian or Chinese factory and which have the possibility of being outside the performance window we select for your amp. And it pains us to hear the hype and mystique built up around biasing when twenty-five years of evidence affirms our decision to make bias circuits that "never need adjustment". How much money and trouble that has saved Mesa/Boogie players you couldn't estimate.

Our rigorously tested and hand selected tubes are available at your nearest Mesa/Boogie Pro Center or from us directly. Nobody offers better price, quality or warranty than we do ... so why swerve?

Next time we'll talk about our part in developing the great Sylvania STR 415 type 6 6 and how we're on the verge of seeing something fairly close reappear on the market. Remember, we still have some of these super rugged mondo-bottles available for older amps — Boogies only please! Until then, Relax, Breathe and Nourish your soul!

Cheers!  
Mesa/Boogie Ltd.

Randall Smith  
Designer & President

## SPEAKER IMPEDANCE MATCHING & HOOK-UP GUIDE:

**IMPEDANCE:** Wiring up speakers to provide the most effective load and making sure that all of them are in phase will help in creating the best sound possible. This is not too difficult, as long as you understand a few things about loading and how to connect your speakers to provide an optimal resistive load.

Mesa Boogie amplifiers can handle 4 and 8 ohms effectively. Never run below 4 ohms in a tube amplifier unless you are absolutely certain that the system can handle it properly; this can cause damage to the Output transformer. A few amplifiers can handle 2 ohms effectively without damaging them ( for example the Mesa's Bass 400+ ). You can always have a higher resistance ( 16 ohms, for example ) without damaging results, but too low of a resistance will likely cause problems.

**MIS-MATCHING:** When running a higher resistance ( for example: 8 ohm output into 16 ohm cabinet ), a slightly different feel and response will be eminent. A slight mismatch can provide a darker smoother tone with a little less output and attack. This response is a result of the amplifier running a bit cooler. Sometimes when using more than one cabinet a mismatch will be the only option.

**WHAT IS MY CABINETS IMPEDANCE:** If you have only a single speaker, you just match that single speakers impedance to the amplifier, and you are done. In many cases, you will have a number of speakers, and then you must calculate the "load" that the amplifier will need to support. There are generally three ways to wire multiple speakers together. They are as follows:

**SERIES:** When you wire ( hook-up ) speakers in Series, the speakers resistance ( as measured in ohms ) is additive - i.e. putting two 8 ohm speakers in Series results in a 16 ohm load.

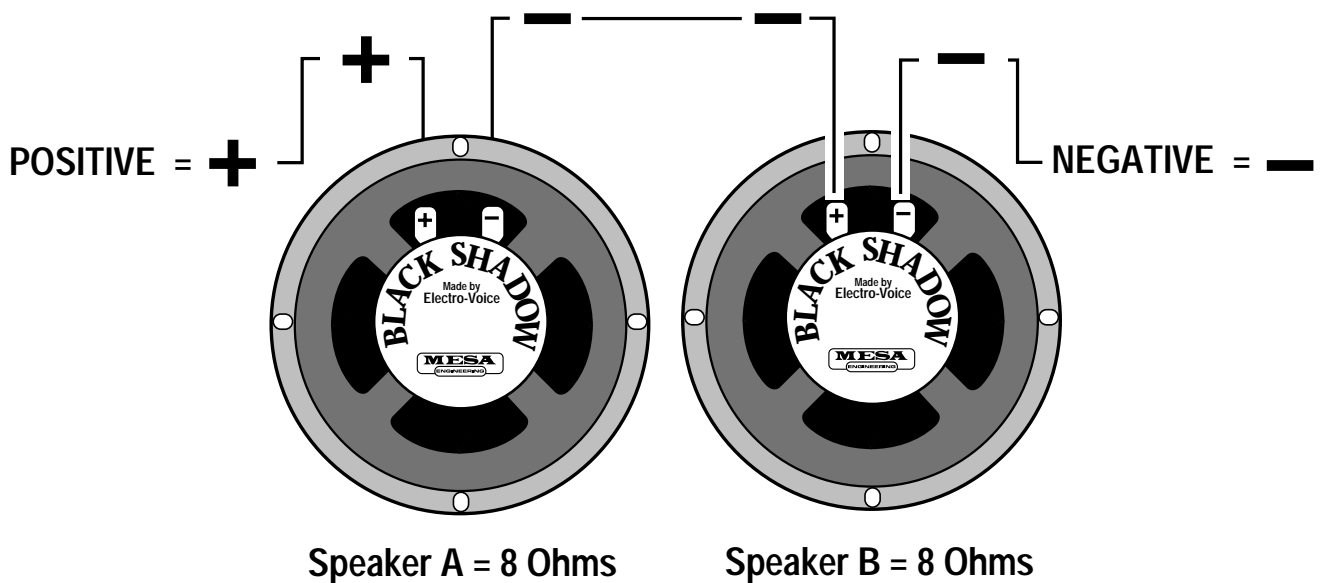

**SERIES:** Connect the Negative side of Speaker A to the Positive side of Speaker B

## SPEAKER IMPEDANCE MATCHING & HOOK-UP GUIDE: *(Continued)*

**PARALLEL:** When wiring in parallel, the resistance of the speakers decreases. Two 8 ohm speakers wired in (hooked-up) Parallel results in a 4 ohm load. It's easy to calculate the effect of a resistive load when all the speakers are all the same resistance. It is really not suggested to wire different resistive load values in Parallel (8 and 4, 16 and 8 etc.) The formula for figuring the total impedance in Parallel is the multiplication of the two loads divided by the sum of the two loads - i.e. putting two 8 ohm speakers in Parallel results in a 4 ohm load. Connect the Positive side of Speaker A to the Positive side of Speaker B - Connect the Negative side of Speaker A to the Negative side of Speaker B.

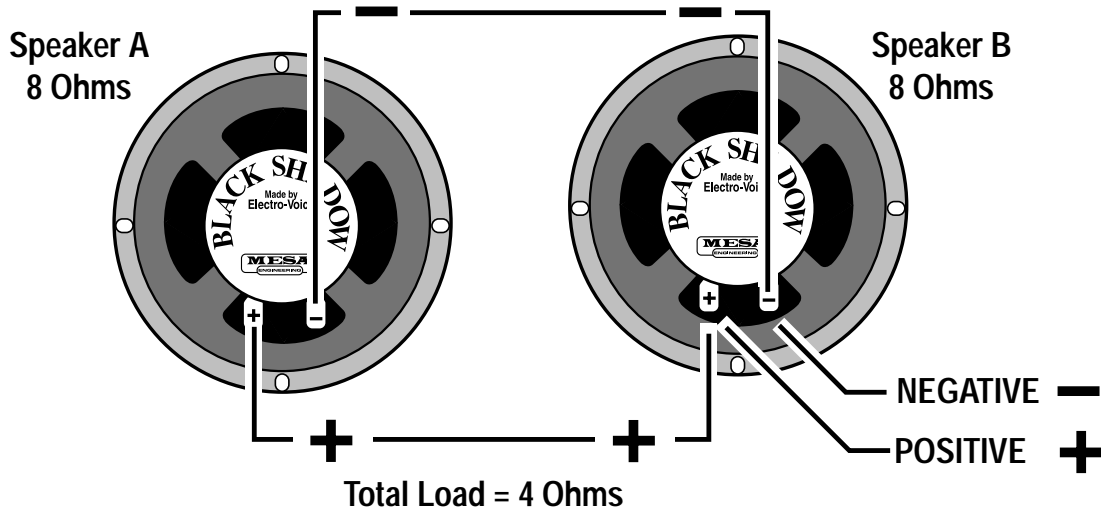

**COMBINATION OF SERIES & PARALLEL:** This is really just two sets of Parallel wired speakers connected in series. This is how you maintain a consistent load with multiple speakers. The importance of this is more evident when you have more than one cabinet to connect to your amplifier. This is when you need to figure out the loads and how to wire them up without applying too low of a resistance on the amplifier.

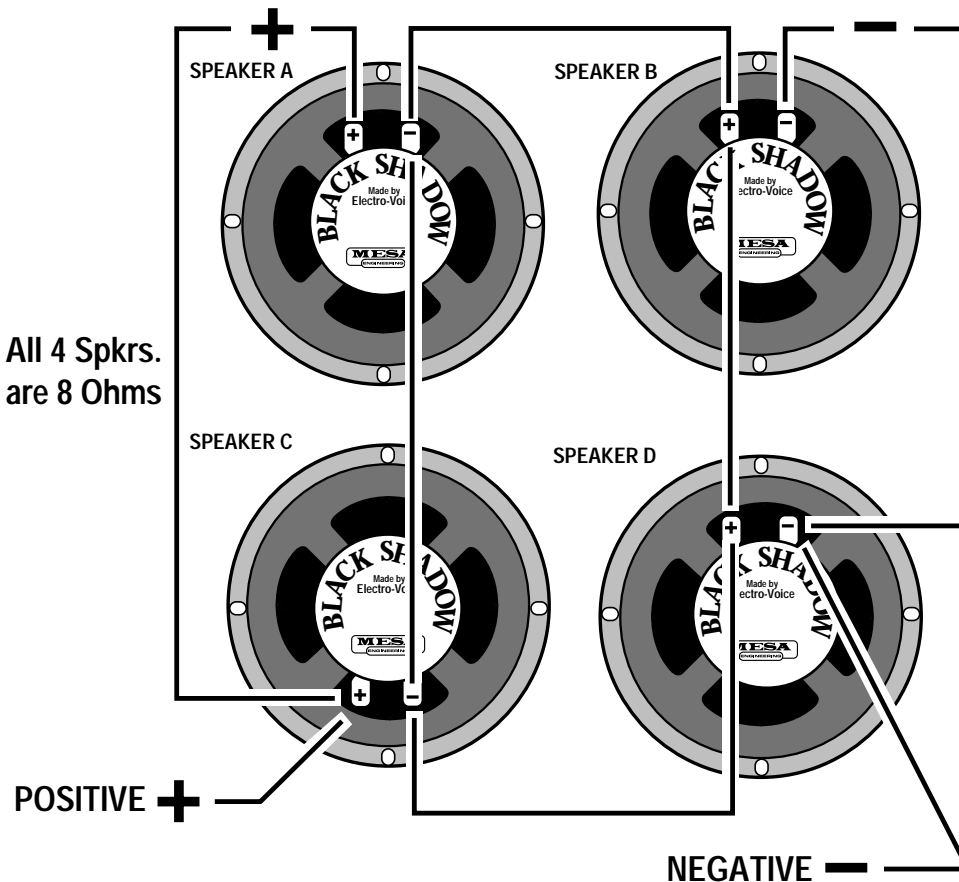

Simply connect the Positive side of Speaker A to the Positive side of Speaker C.

Connect the Negative side of Speaker A to the Positive side of Speaker B, then on to the Positive side of Speaker D and finally on to the Negative side of Speaker C.

And lastly, connect the Negative side of Speaker B to the Negative side of Speaker D.

4 Eight (8) Ohm speakers wired in Series Parallel = a Total Load of 8 Ohms.

# WIRING SCHEMES...Amplifier to Speaker Cabinets

1

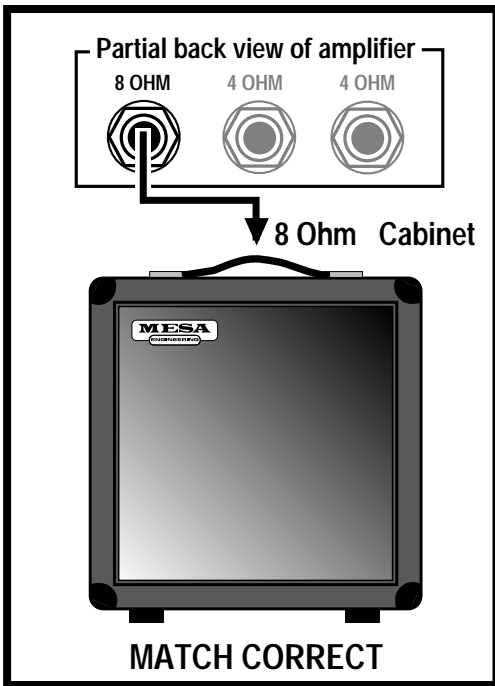

2

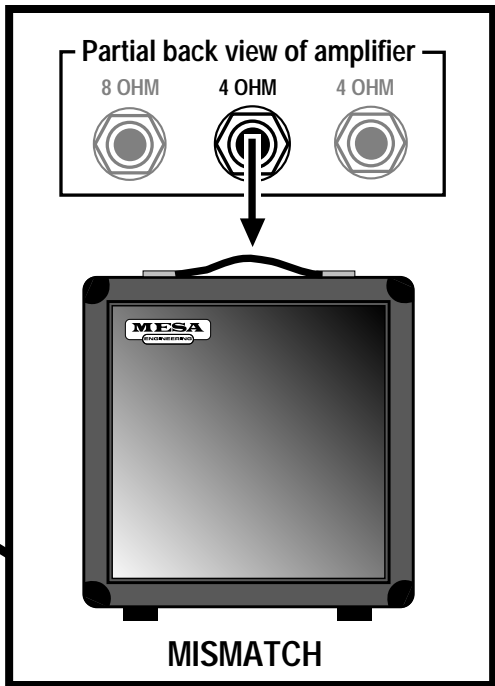

3

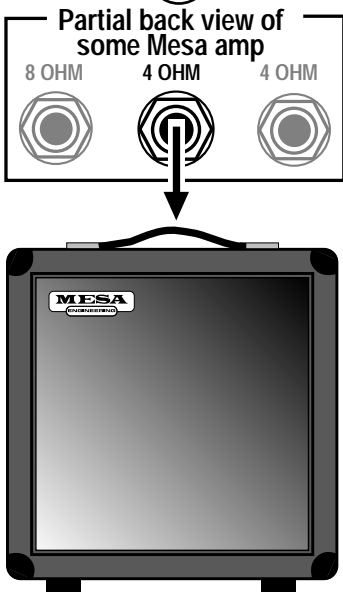

4

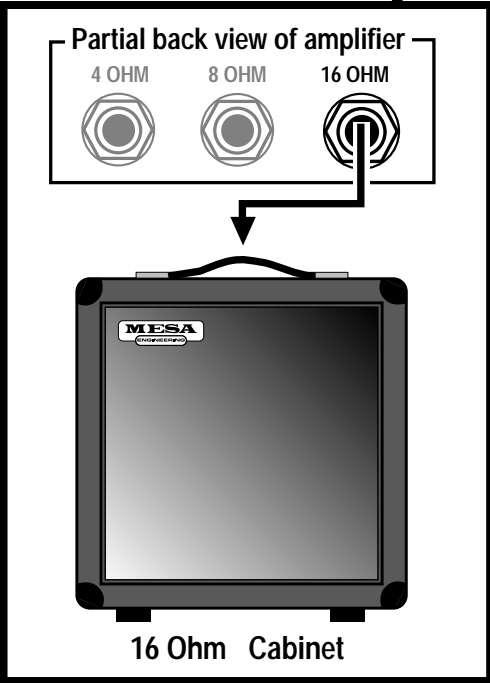

5

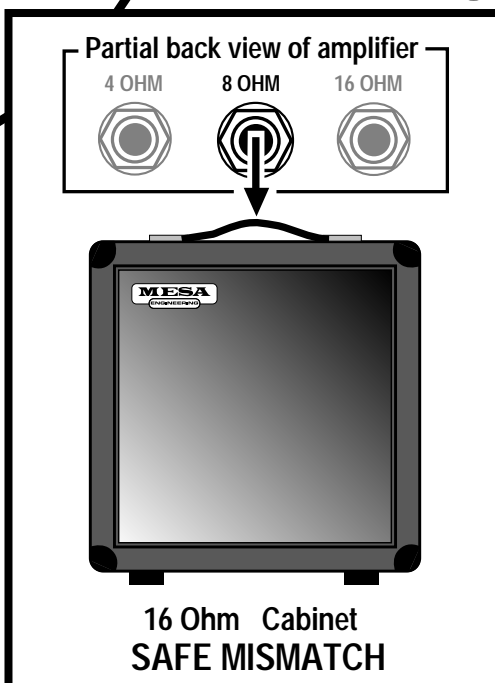

6

# WIRING SCHEMES...Amplifier to Speaker Cabinets

7

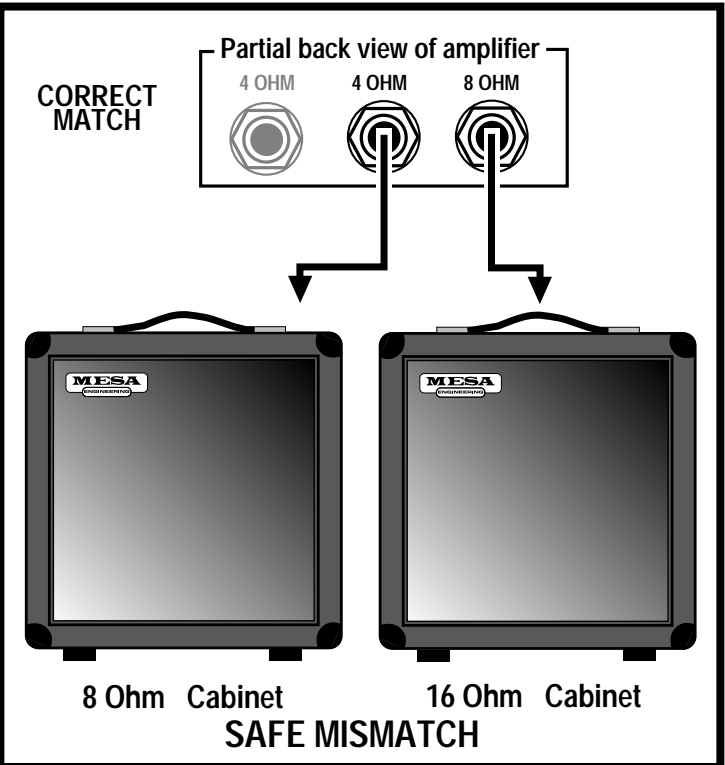
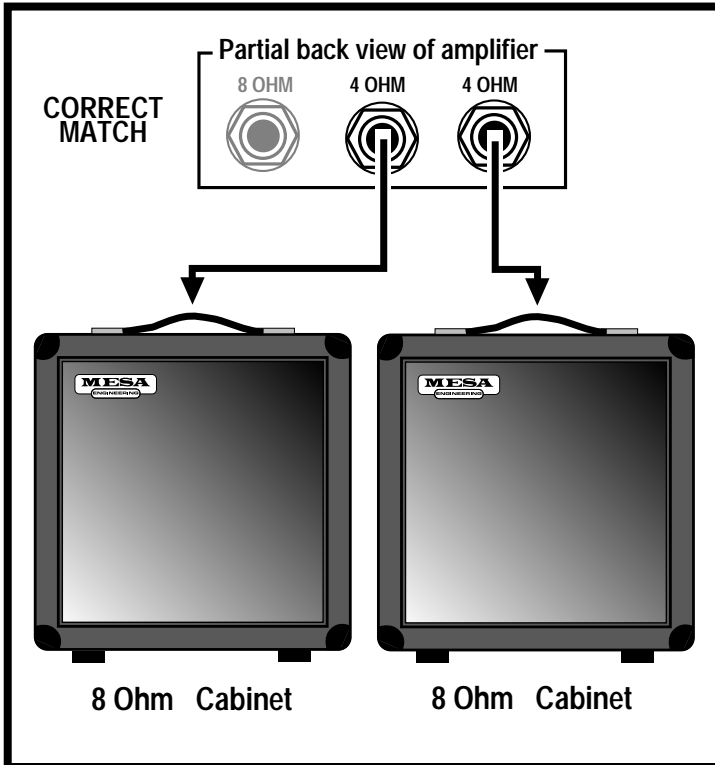

8

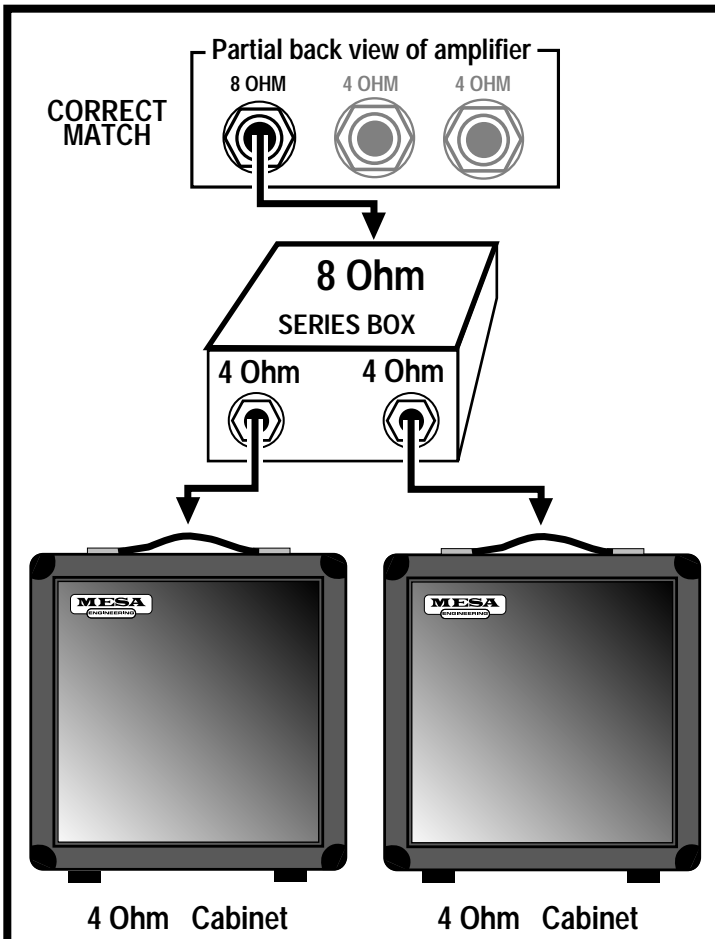

9

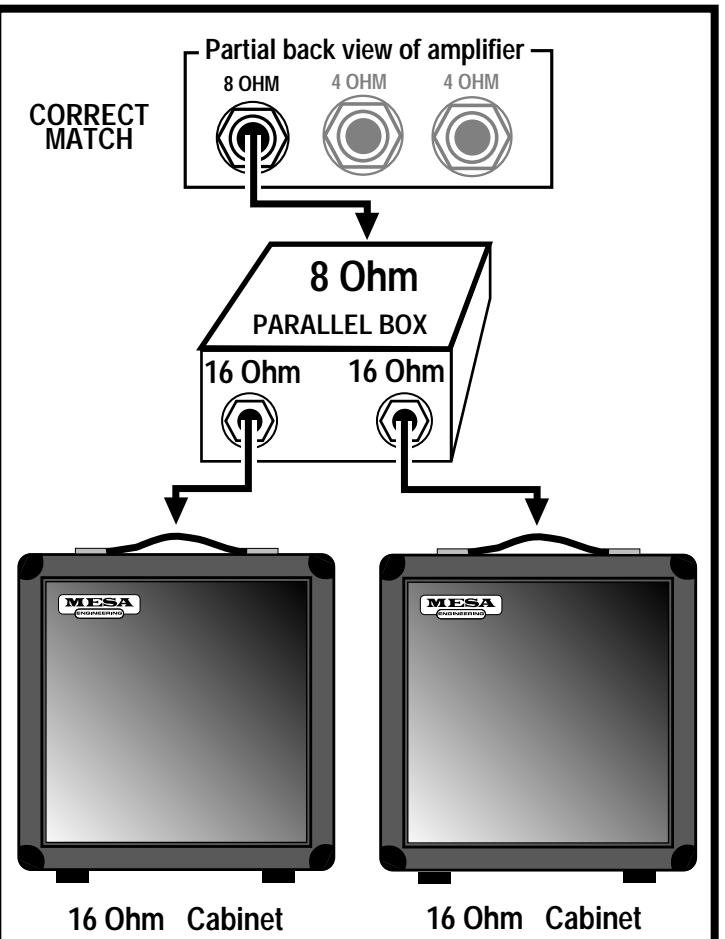

# WIRING SCHEMES...Amplifier to Speaker Cabinets

10

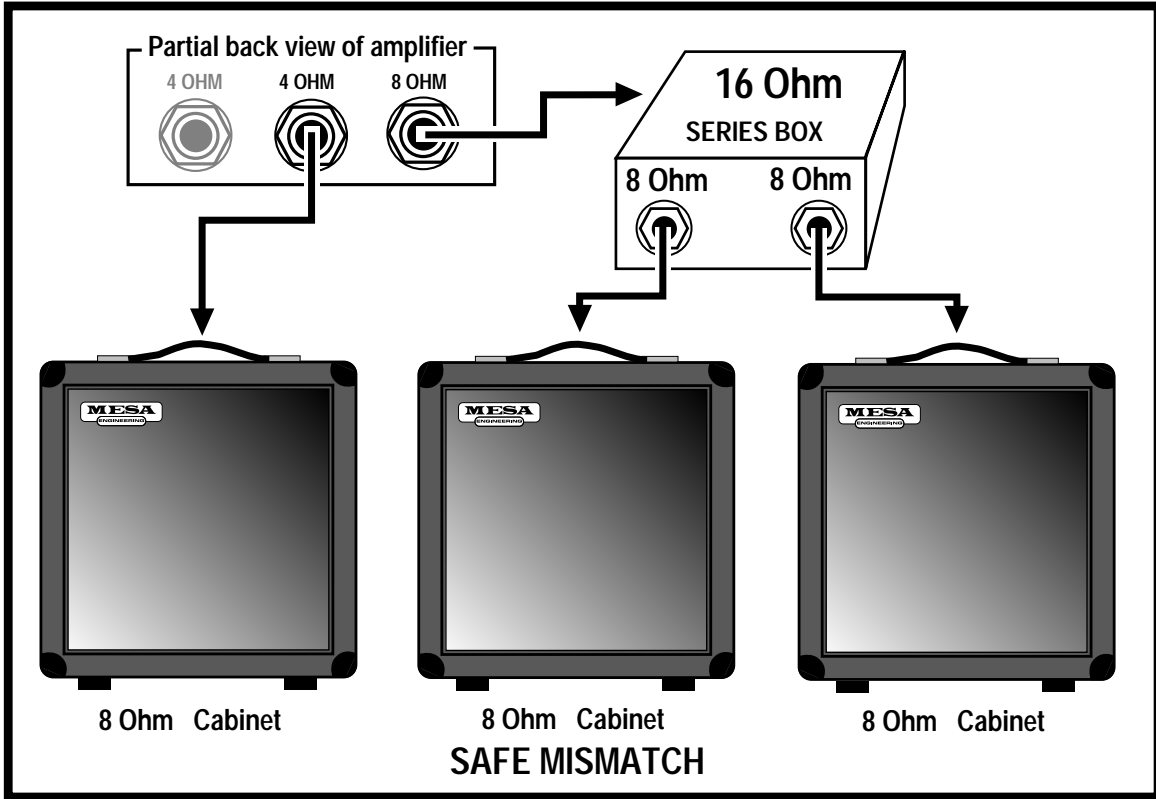

11

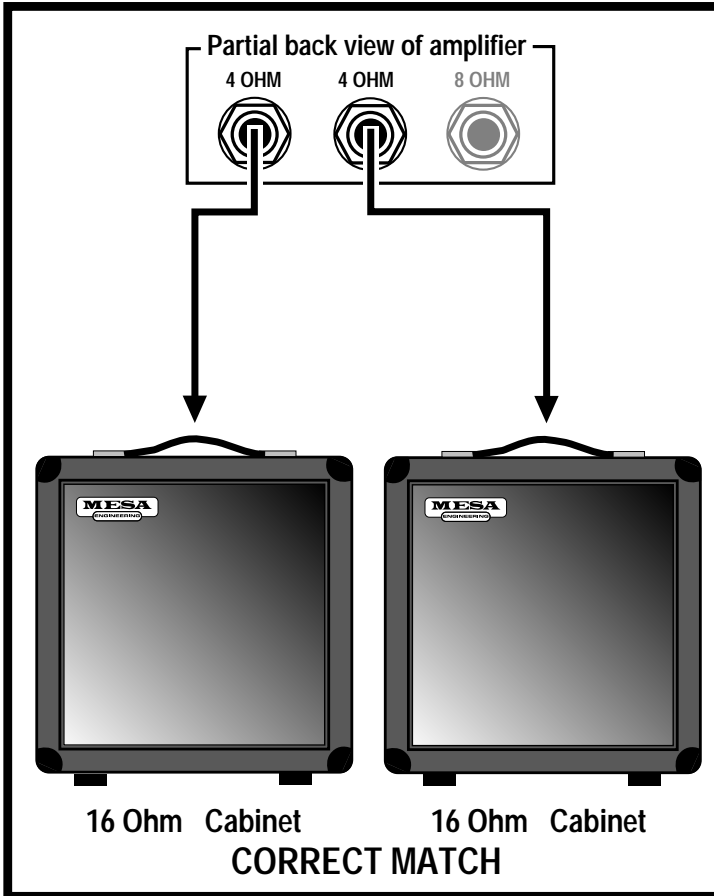

12

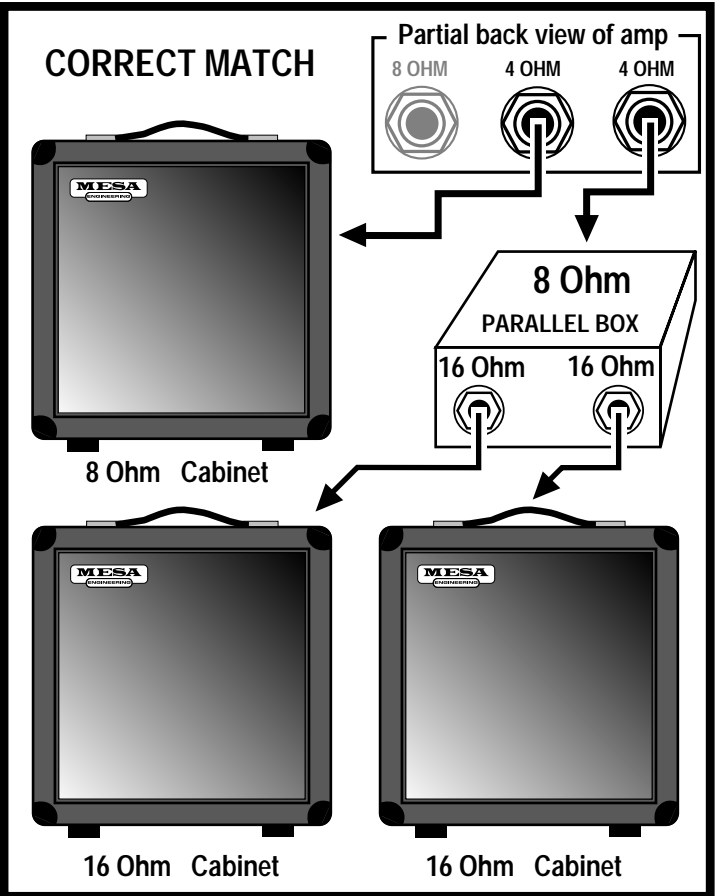

# WIRING SCHEMES...Amplifier to Speaker Cabinets

13

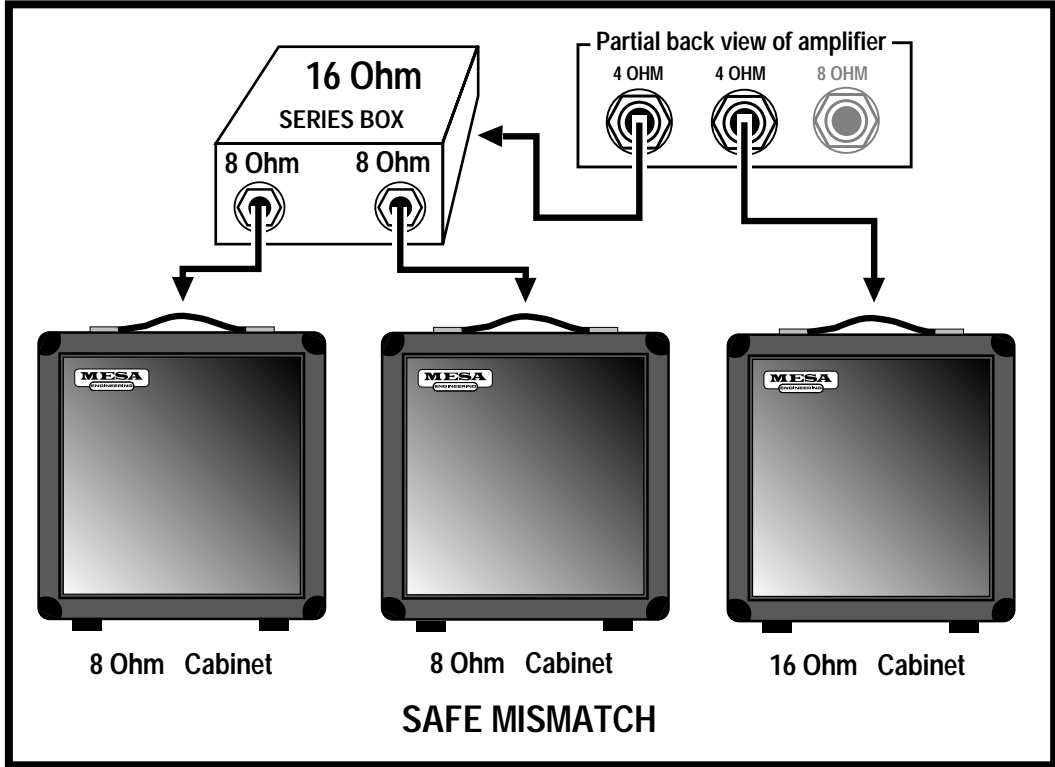

14

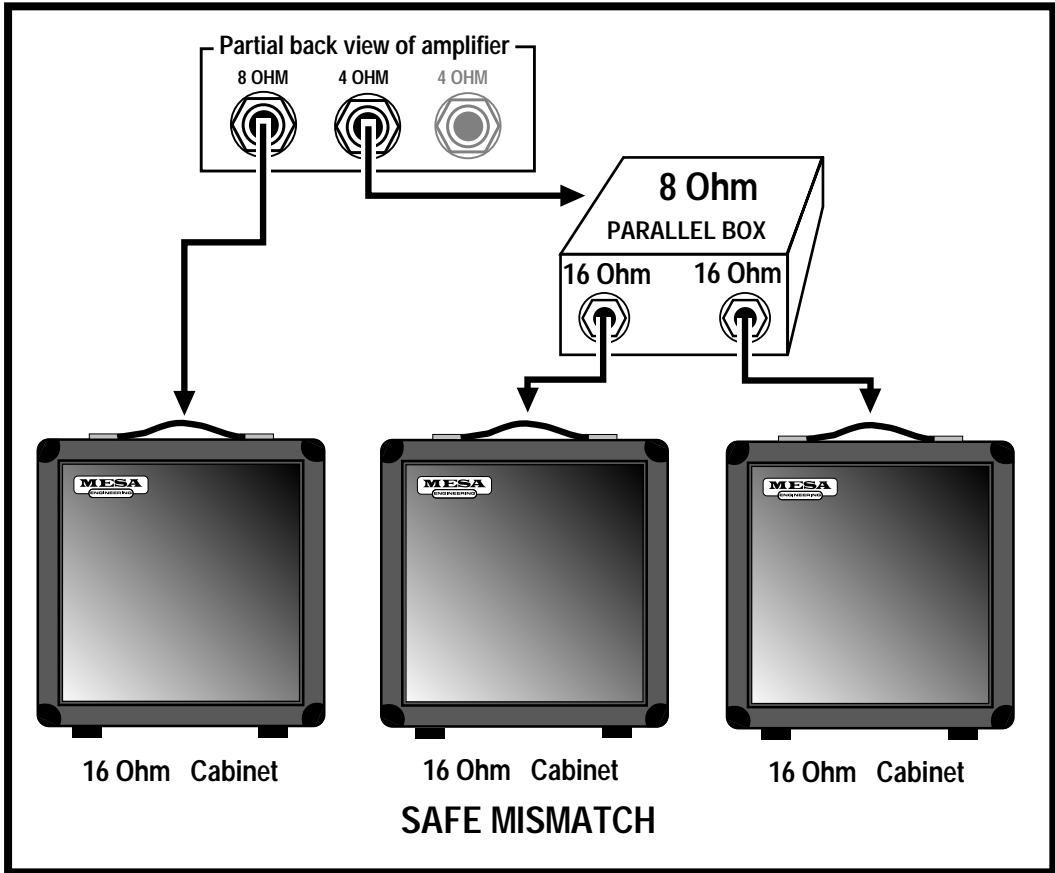

With apologies to Friends and Relatives from the Emerald Isle - who will make their appearance soon enough - the humor which follows is dedicated to the memories of Spec McAuliff and Fae (Rafael) McNally, two of the True Greats.

As their numerical references suggest, the terms Diode, Triode and Pentode indicate the number of elements within the vacuum tube i.e. two, three or five. All tubes also require a filament or heater which is not included in the count. Its purpose is to excite electrons from the cathode coating by raising the temperature such that they are able to boil out of the electron-rich coating material and form a cloud of free electrons in the vacuum space surrounding the cathode.

Although the term filament and heater are often used interchangeably, there are specific differences: A filament is a directly heated cathode where cathode coating is applied directly to the heating element. Examples are 5U4 twin diode rectifier and 300B triode amplifier tubes.

A heater, on the other hand, is a heating element which is separate from the cathode and is usually inserted within the tubular cathode sleeve. Examples are 12AX7 twin triode amplifier and 6V6 or EL84 beam power pentode tubes. In all cases this fundamental aspect of each tube's construction is clearly visible, especially when the heating element is glowing red hot.

The cathode, then, would be considered the first numbered element because it is the source of the electrons. The word itself is from the Greek literally meaning completely down, which implies a sense of central origin - like the center of the earth where Tone begins. It might be said that an ecstatic audiophile experiences a positive catharsis, his soul being purified when his system transports him to Audio Nirvana. The only trouble with taking this positive imagery too far is that the cathode is, unfortunately, negative... at least electrically speaking. However this is easily remembered since virtually all musicians and audiophiles have also experienced the more common negative catharsis when they emerge from the emotional rebirth kicking and screaming in rage and frustration.

Once heated, the intrinsically negative electrons are energetic little fellows of almost no mass. Thus they may be accelerated almost instantaneously and will travel through a vacuum a nearly the speed of light. Being of like, negative charge, they tend to repel one another and thus within the electron cloud surrounding the cathode, there is much jostling and elbowing as each one tries to maintain his distance from all the others... unless there is a strong and universal attraction from an outside influence.

Visualize, if you will, a group of sub-atomic Irishmen milling about and in a repellent, negative state of mind. All are scowling and none wants to have anything to do with the other. Now introduce a strong attraction say, a public bar, and you can easily picture an orderly, if rapid movement of the lot in a single direction. This is what happens when a positively charged element called the anode or plate is introduced into the vacuum.

The plate is the large metal element most prominently visible through the glass of an electron tube. It is the outermost element of a tube's structure and it surrounds all the others. The cathode is at the center radiating electrons outwards. As higher and higher positive voltage is applied to the plate, the attraction for the electrons surrounding the cathode is increased and with nothing standing in the way, full uninhibited flow to the plate occurs... sort of like removing the doors and offering free drinks to the crowd of surly Irishmen milling around outside. As electrons flow to the plate, the space charge will continually be replenished by further 'boiling' of the hot, electron-rich cathode as you can easily imagine other Irishmen impatiently taking up the places of those who've gone inside - until the entire village is deserted.

Now, where do they come from and how do they emerge? Well, a grand and elegant lady once showed me how to revive flat champagne: She dropped a raisin into the glass. There was a dramatic and immediate increase in effervescence with the introduction of a cathoding surface. Thousands of tiny bubbles suddenly appeared - and continued to flow from the raisin. Of course the bubbles were made up of gas dissolved in the beverage, but the analogy makes it easy to visualize the loosely bound electrons dissolved in the rich cathode coating as they effervesce from its heated surface.

But back to the electron flow. If the electrons are strongly attracted to a positively charged plate, then it follows that they are strongly repelled by a negatively charged plate and they are. Thus, if an alternating current - such as comes from a transformer - is applied to the plate, electrons will flow only during the times when the plate is positively charged. During periods of negative plate charge, electron flow is stopped and the space charge of electrons remains compressed in the area around the cathode.

## ON TRIODES, PENTODES & IRISHMEN: (Continued)

Thus a diode tube - one with a cathode and an anode - is mostly used to rectify alternating current into direct current by passing it without restriction, but in one direction only. This also explains why closing time is strictly enforced at Irish pubs: During normal operation, the traffic flow is similarly unimpeded and uni-directional toward the bar and this process rectifies the work-day negativity. It goes without saying that no one leaves as long as the atmosphere around the bar remains positively charged.

**TRIODES:** This section is a continuing technical treatise on the workings of Irish Pubs but to make it easier for the layman to understand, it is explained in terms of vacuum tube technology. Enter the original bar - free beer and no doors. Well, it turns out that some control over the flow can be a necessary and useful advantage. This led to the invention of those swinging louvered saloon doors which are open at the top and bottom. They are patterned after the control grid of the vacuum tube, which is a loosely wound coil of thin wire located between the cathode and the plate.

In a Triode the plate is always positively charged with high voltage D.C. and even though the grid is blocking the path, those negative electrons can still FEEL the strong attraction - just as the Irishmen can see in through the louvers of the bar doors. They know what pleasures lie beyond, but to get there requires overcoming the negative influences controlling the access. This negative influence is typically called a Bias. In electronic terms that means the grid is supplied with a voltage which is slightly MORE NEGATIVE than the already negative electrons. The more negative the Bias, the more it tends to neutralize the attraction of the plate and repel the electrons back toward the cathode.

The Irish can be similarly charged with Bias, but unless you are Irish yourself, this type of Biasing may be more difficult to understand. The effect is similar though: The more negative the Bias, the more it impedes forward progress. Generally speaking though, the electronic Bias of the grid is easier to overcome, and for two main reasons: First, the Bias is set - like the bar doors - to allow some passage. Second, the grid is mostly NOT THERE, like the louvered doors which are mostly open spaces. Unlike the plate which is solid, the grid is like a coiled bed spring. It can create a repelling field but mostly it's empty space in between widely separated windings of wire. It's very easy to control the electrons as they pass through the grid's force field: Changing the grid voltage only slightly will have an enormous effect on how much current flows through... and that's what AMPLIFICATION is: a small change in voltage at the grid causing a large change in current flowing to the plate.

The purpose of the louvered bar doors is similar to that of the grid, namely, to give momentary pause while still revealing the promise within. Hesitation mostly gives way to temptation, but there are those few stalwart Irishmen who think twice and decide to come back later. Most just pause slightly then go on through. That is the purpose of the bar doors: to prevent everyone from crowding in all at once - and as the door is made less of a barrier, wider spaces between the louvers, more of the bar's attractive influence is felt outside thus amplifying the customer flow and increasing the crowd at the bar.

**PENTODES:** Occasionally though, bar doors - even the louvered type - were found to be too effective, and too many customers turned away. Something further was needed to increase the attraction of the bar and overcome the resistance created by the door. Thus the cocktail waitress was invented.

Once again the idea was inspired by the vacuum tube. It had been discovered in some tubes, often large power types, that the distance to the plate was too great to attract enough electrons past the negative influence of the control grid. So another grid coil of fine wire was inserted between the first grid and the plate. This was called the screen grid and carrying a highly positive charge, it functioned as a "bait" for the plate.

In a properly designed power tube such as an EL84 or a 6V6, the windings of the screen grid are precisely aligned to fall in the shadow of the control grid. This way the electrons responding to the pull of the screen grid are lined up in sheets as they pass between windings of the inner control grid... only to find that they have been fooled! Once past the control grid and drawn toward the screen grid, they discover...there's almost nothing there. The path they're on has them aligned to zing straight through the spaces BETWEEN screen grid windings. So rather than a close and personal encounter, they just fly on past - and once they're out that far, there's no stopping them. The influence of the plate takes over and - being solid metal and of the highest positive attraction - it is at this final destination that the electrons congregate.

**PENTODES:** *(Continued)* Thus the proper cocktail waitress - visible through the louvers - is scantily clad so as to be all the more effective at reinforcing the attractive influence of her bar and by being located in between the door and the bar, she serves as bait to lure customers past the door's negative influence. Once through the door however, it is the rare Irishman who actually comes in personal contact with the cocktail waitress as, for all intents and purposes, she - like the screen grid - turns out to be a vanishing illusion. Yet, having come this far, the solid influence of the bar itself now takes over and attracts the customers to congregate, having happily reached their destination.

If you're still following this and haven't lost track of the count, you'll know we're still one element short of the five needed to make a Pentode. This last part is a pair of beam-confining shields which being negatively charged, serve to direct the flow right toward the plate. This is much the way a short entrance hall to the bar prevents wandering accidentally into the Men's room on the way.

Once at the bar though, the circuit is complete and the process of soul-nourishing works its ritual magic. Biases having been overcome, illusory nightingales having vanished, the spirits truly soar and the once surly Irishmen now are filled with warmth, wit and kindred friendship, enjoying the music and glowing nicely with their heaters on.

With appreciative thanks to the inhabitants of the Land of the Leprechaun, we have now concluded our little diversion into the mechanics of proper bar lay-out.

A feature article by Randall Smith  
Designer / President

# FRONT PANEL Nomad 45

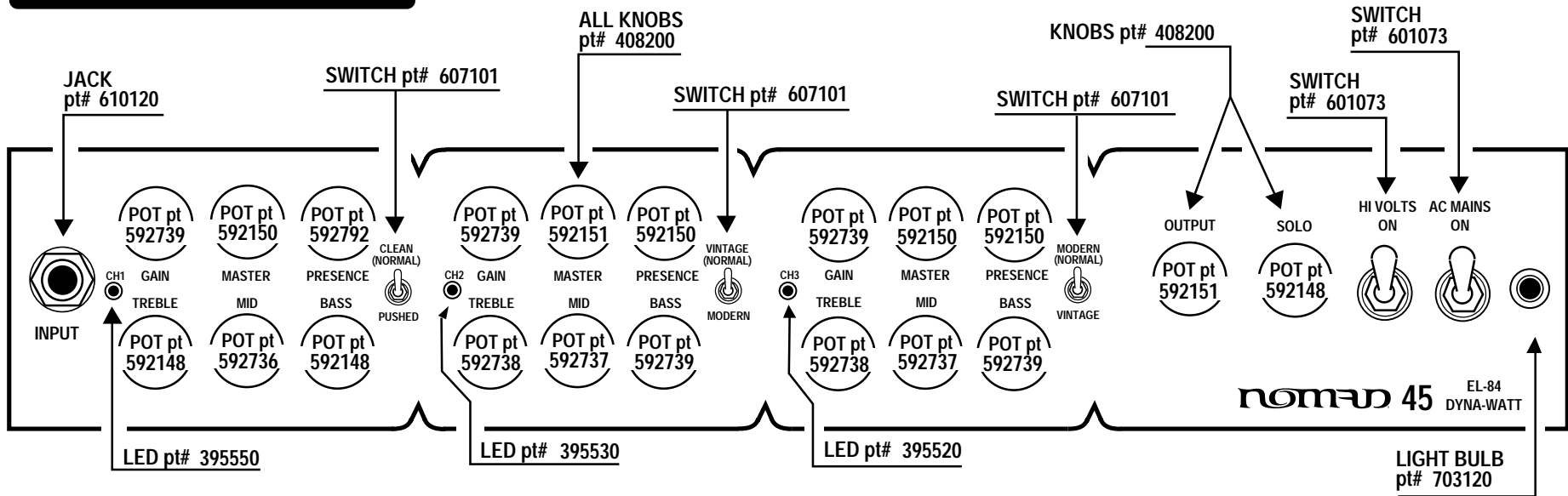

# REAR PANEL Nomad 45

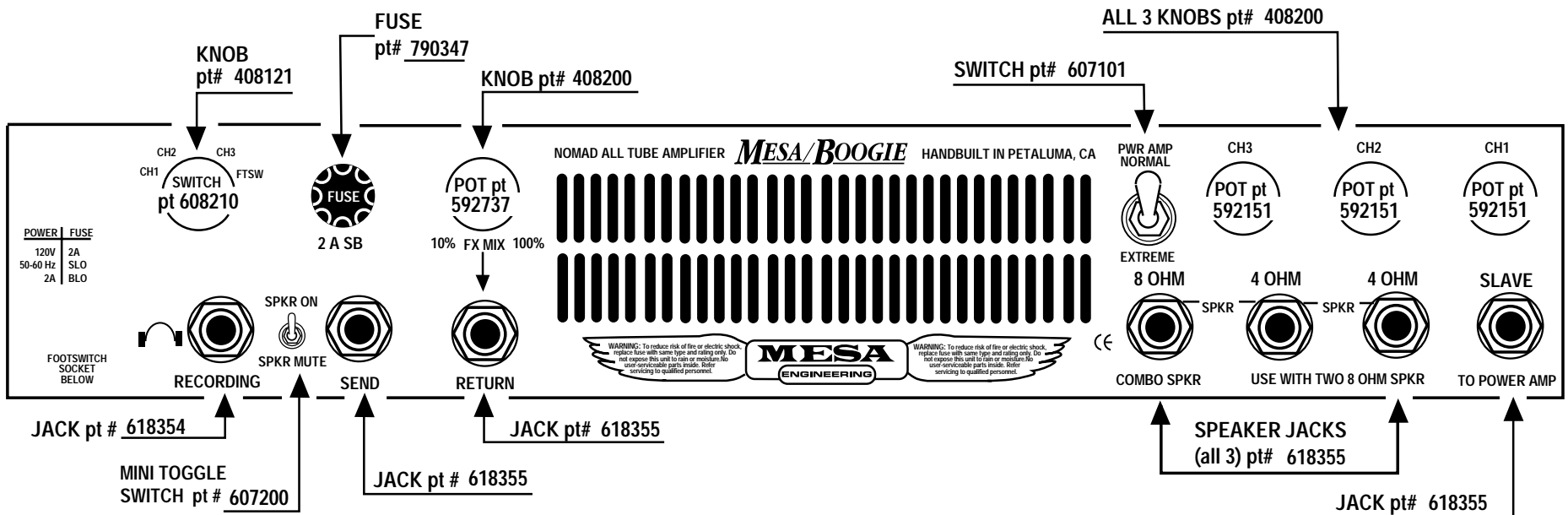

# FRONT PANEL Nomad 55

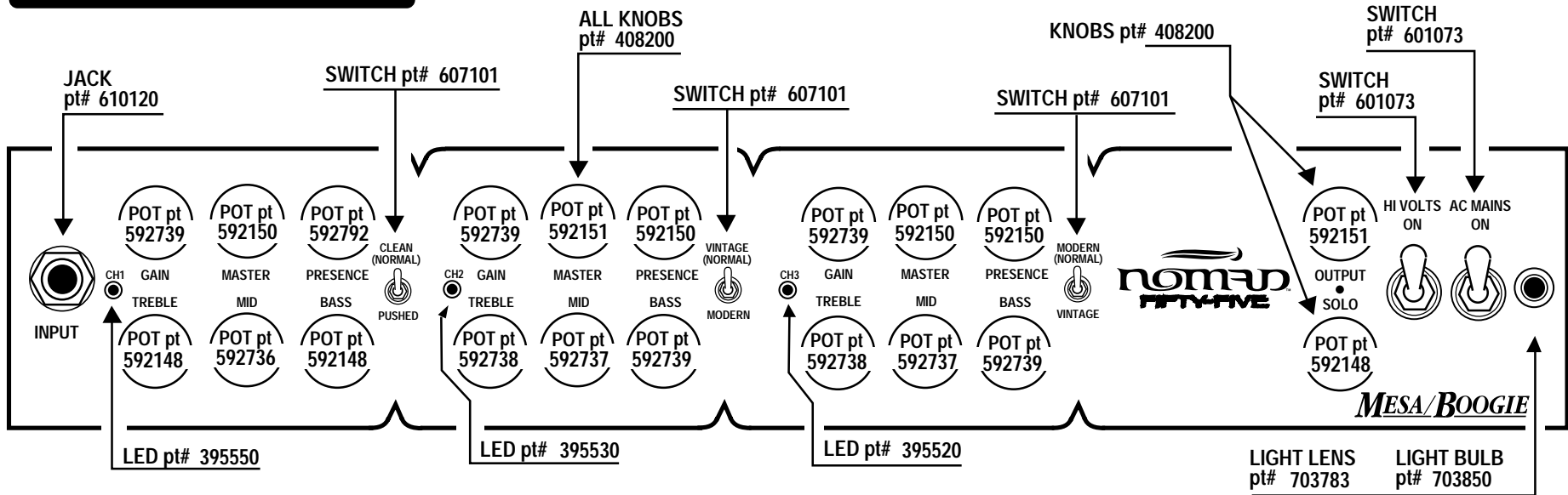

# REAR PANEL Nomad 55

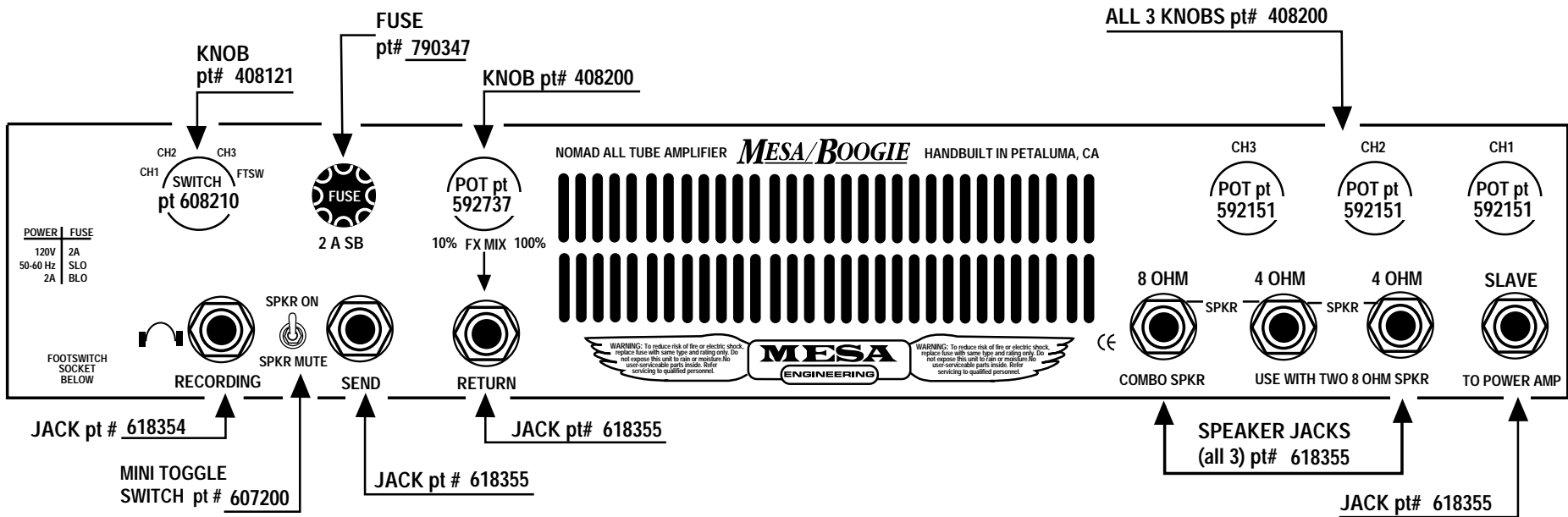

# FRONT PANEL Nomad 100

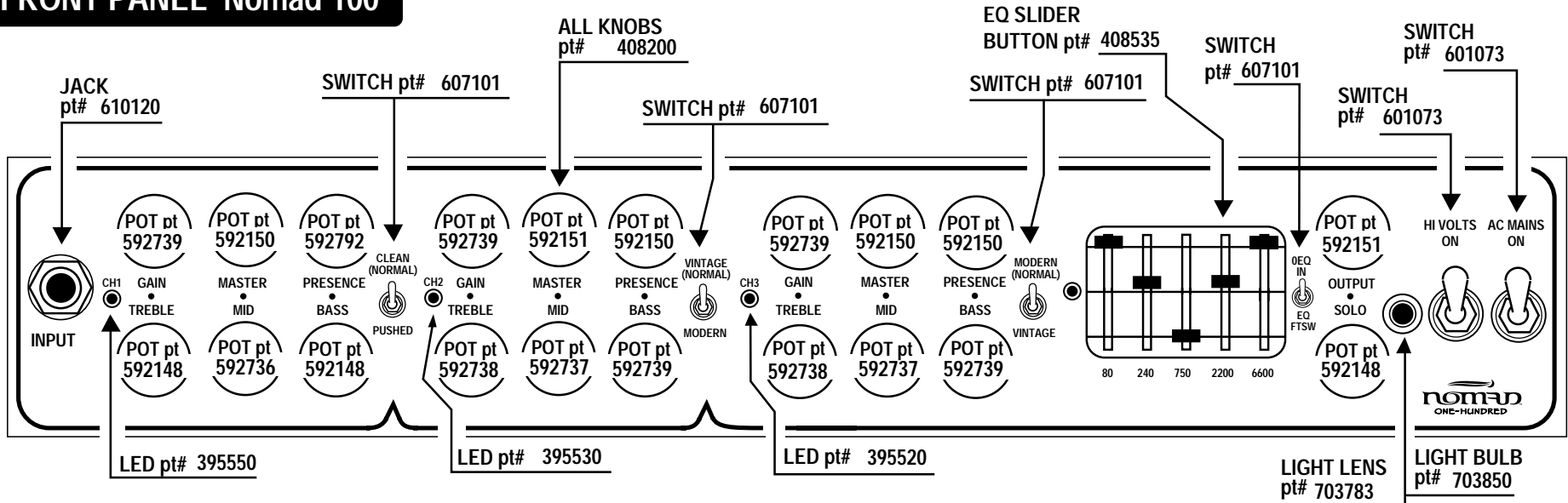

# REAR PANEL Nomad 100

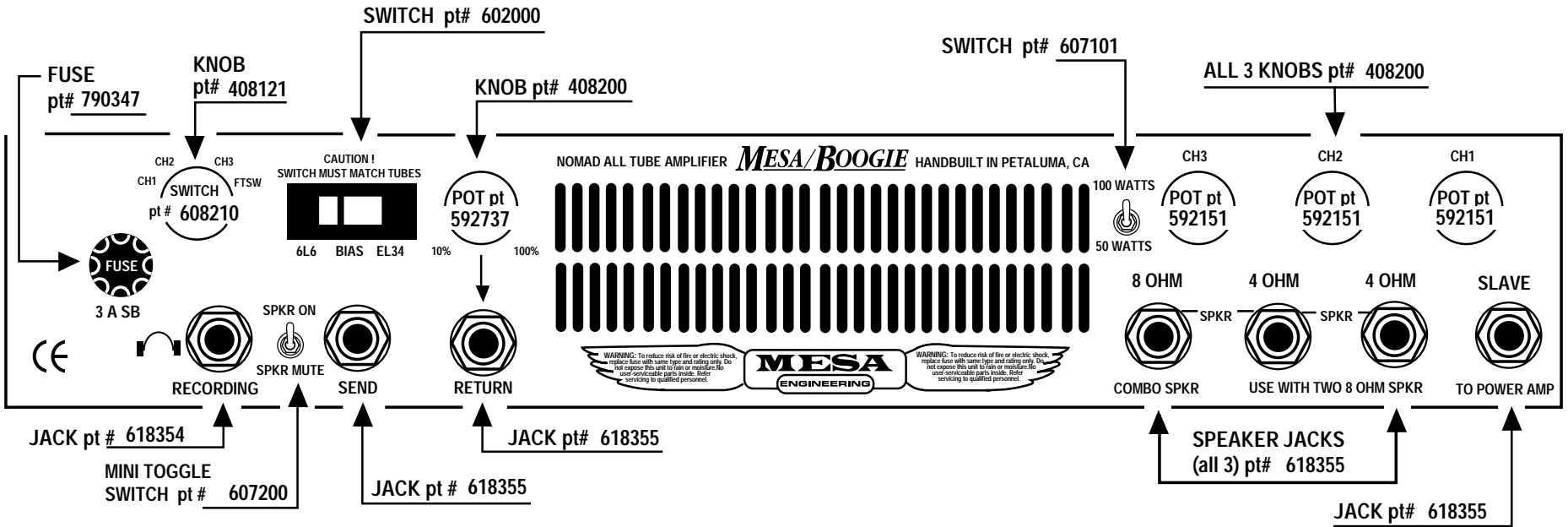

# ***MESA/BOOGIE***

***The Spirit of Art in Technology***

***Thank you for trusting MESA/Boogie to be your amplifier company and we wish you many years of toneful enjoyment from this handbuilt all tube instrument.***

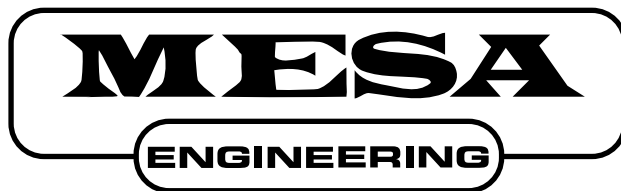

*The Spirit of Art in Technology*

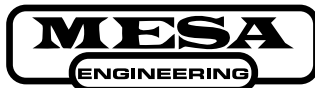

*(707) 778-6565      FAX NO. (707) 765-1503*  
*1317 Ross Street Petaluma, CA 94954*  
*USA*